

Allsteel®

Storage

SPECIFICATION AND PRICE LIST 2017

prices effective January 29

Align™ Metal Storage
Essentials™ Metal Storage
Involve® Laminate Storage
Align Veneer Storage

Storage

Finishes

PAINTED METAL FINISHES

C CORE COLORS GRADE P1

Black	P27
Brownstone	P7D
Bungalow	P7C
Carob	P52
Flint	P02
Fossil	P28
Loft	P7B
Muslin	P4J
Parchment	P93

S SELECT COLORS GRADE P2

Brilliant White**	PQ8
Champagne Metallic	PR5
Gunmetal Metallic	PR3
Platinum Metallic	PR2
Silver**	PR6

**PR6 no upcharge on Involve; available as Select color on Align stanchions; is not available on Stride trim for panels and tiles, Optimize, Concensus, Cadence, Align, Essentials, and vertical files. PQ8 is not available on vertical files.

A ACCENT COLORS GRADE P3

Flame	P7G
Ocean	P7H
Sprout	P7F
Tangelo	P7E

PAINT COLOR INDICATORS
Pages in this pricer reference the following symbols:

- C** CORE PAINTED METAL COLORS
- S** SELECT PAINTED METAL COLORS
- A** ACCENT PAINTED METAL COLORS

Metallic paints, due to varying reflectance, may appear to have less visual color consistency than other paint finishes, even when L/A/B values are exactly the same. (L/A/B — measurable aspects of color — values are maintained within a specified range, to ensure consistent appearance of paint colors.)

METAL STORAGE PULLS

Black	E4
Bronze (for veneer only)	EZ
Matte Silver	EL

PAINTED WOOD FINISHES

Brilliant White	M14
Brownstone	M13
Bungalow	M12
Flint	M16
Loft	M11
Muslin	M15

ELECTRICAL AND DATA COMPONENTS

Black	E4
Brownstone	EY
Bungalow	EX
Flint	E9
Loft	EV
Muslin	EU
Silver	ES
White	EW

Recommended Coordinate Colors:
Brilliant White use White EW
Carob use Black E4
Champagne Metallic use Muslin EU
Fossil use Flint E9
Gunmetal Metallic use Brownstone EY
Parchment use Muslin EU
Platinum Metallic use Loft EV

LAMINATES

GRADE L1

CORE

Ash	LT3B
Brownstone*	LM13
Bungalow*	LM12
Camelstone	LT6A
Canyon Zephyr	LT5B
Desert Zephyr	LT5A
Flint*	LM16
Frosty White*	LM14
Grey Mesh	LT8A
Greystone	TM65
Loft*	LM11
Muslin*	LM15
Parchment	TM20
Pewter Mesh	LT8C
Sheer Mesh	LT8B
Silver Mesh	LT8D
White Tigris	LT2A
Whitestone	TM33

WOODGRAIN for Involve

Natural Maple*	LWD
Shaker Cherry*	LW7C

GRADE L2

Amber Cherry*	LWAC
Beigewood*	LWBE
Branded Oak* NEW!	LBO1
Brazilwood*	LWBR
Columbian Walnut*	LWZ
Ebony Recon* NEW!	LER1
Fawn Cypress* NEW!	LFC1
Lowell Ash*	LLA1
Mangalore Mango* NEW!	LMM1
Natural Recon*	LNR1
Phantom Charcoal* NEW!	LPC1
Phantom Ecru*	LPE1
Portico Teak*	LPT1
Skyline Walnut*	LSW1

GRADE L3

Cafelle*	LWC
Charcoal Walnut*	LWCW
Natural Walnut*	LWNW

* Storage available in these 25 laminates.

LAMINATE AND PAINTED WOOD STORAGE PULLS

Silver	PR6
--------	-----

LAMINATE EDGE COLORS

Amber Cherry	DA
Beigewood	DE
Black	E4
Branded Oak NEW!	BO
Brazilwood	DB
Brownstone	EY
Bungalow	EX
Cafelle	DG
Carob	E8
Charcoal Walnut	DC
Columbian Walnut	DZ
Ebony Recon NEW!	DR
Fawn Cypress NEW!	FC
Flint	E9
Fossil	EH
Loft	EV
Muslin	EU
Lowell Ash	DL
Mangalore Mango NEW!	MM
Natural Maple	DD
Natural Recon	NR
Natural Walnut	DN
Parchment	EN
Phantom Charcoal NEW!	PC
Phantom Ecru	PE
Platinum Metallic*	EP
Plyband ♦	PL
Portico Teak	DP
Shaker Cherry	DF
Skyline Walnut	SW
White	EW

NOTE: \$33 upcharge on Woodgrain T-Mold.

† Not available on Aware table tops.

♦ Edge is limited to flat edge surfaces: rectangle, square, trapezoid, polygon, or round. No curvilinear or combination curve and straight. No T-Mold.

METAL GROMMETS

FOR LAMINATE WORKSURFACES

Oval/Square:	
Matte Silver	EL

FOR VENEER WORKSURFACES

Oval:	
Black	E4
Bronze	EZ
Matte Silver	EL
Square:	
Matte Silver	EL

PLASTIC GROMMETS

FOR WORKSURFACES

Black	E4
Brownstone	EY
Bungalow	EX
Carob	E8
Flint	E9
Fossil	EH
Loft	EV
Muslin	EU
Parchment	EN
White	EW

PLASTIC GROMMETS WITH WOODGRAIN EDGE

If woodgrain edge is specified, the plastic grommet color is predetermined, based on finish selection.

Beigewood, Fawn Cypress, Natural Maple, and Natural Recon	Muslin EU
Branded Oak	Brownstone EY
Phantom Charcoal	Flint E9
Phantom Ecru	Loft EV
Portico Teak	Fossil EH
Skyline Walnut	Flint E9
All other woodgrain options	Black E4

STRATAWOOD VENEERS

GRADE V1

Add FSC prefix to Stratawood codes listed below for Stratawood veneer trim on Stride and Terrace.
Example: FSCSC777

CHERRY

Burnished Cherry	SC777
Light Cherry	SC701
Wheat Cherry	SC706

MAPLE

Clear Maple***	SE800
----------------	-------

OAK

Clear Oak	SF300
Dark Rift Oak	SF331

WALNUT

Coffee Walnut	ST615
Dark Roast Walnut	ST684
Light Walnut	ST601

NATURAL VENEERS — NATURAL-1

GRADE V3

CHERRY

Burnished Cherry	NC777
Light Cherry	NC701
Medium	
Wheat Cherry	NC706

MAPLE

Natural Maple***	NE800
------------------	-------

WALNUT

Coffee Walnut	NT615
Dark Roast Walnut	NT684
Light Walnut	NT601

NATURAL VENEERS — NATURAL-2

GRADE V5

Dark Rift Oak	RF331
***SE800 and NE800 are not available on Stride trim.	

The beauty of wood is the natural variation of grain patterns and colors that make each piece unique. This variation is also influenced by lighting conditions, orientation of mated parts, and varying acceptance of the finishing process. The varying colors and physical characteristics naturally occur in all wood species but are most pronounced in lighter colored woods, and are especially evident in natural finishes.

GROMMETS ON VENEER WORKSURFACES

Wire management grommets come standard on most veneer worksurfaces. Choose between metal or plastic grommet option. Note: Plastic grommet color is predetermined based on finish selection.
All Maple veneers..... Muslin EU
All other veneers..... Black E4

LOCKS

Black	E4
Chrome	ordered by base model
Matte Silver	EL

NOTE: Refer to individual product pages for upcharges.

- Software support packages furnished to the customer, either by Allsteel® or by another source, which support the sale of Allsteel products are superseded by printed price lists.
- Prices are subject to change without notice. All orders are subject to prices in effect at the time of order.
- Please refer to your Allsteel Dealer Sales and Discount Policies for order placement information and terms and conditions.
- Additional copies of this Specification and Price List are available upon request from Allsteel Literature Fulfillment at 1-866-255-7833.

- Ordering information appears at the bottom of each product page complete with examples on how to specify. Fabric and finish pages are referenced at the bottom of product pages.

This publication is available as an interactive or downloadable PDF at www.allsteeloffice.com.

Questions or Comments?

Please call us at: **888-ALLSTEEL**
888-255-7833

New, Revised, and Discontinued Products 4
 Warranty, COM, Specials Policies, and Programs 5-9
 Storage Overview 10-16

METAL STORAGE

Working with Align™ Metal Storage..... 17-33
 Align Metal Pedestals 34-37
 Align Low Metal Storage..... 38-43
 Align Metal Lateral Files 44
 Align Storage Tops 45
 Align Metal Towers 46-49
 Align Lockers 50-58
Working with Essentials Metal Storage 59-70
 Essentials Metal Pedestals..... 71-73
 Essentials Metal Personal Files and Towers 74-75
 Essentials Metal Lateral Files..... 76
 Essentials Metal Combination Files..... 77
 Essentials Metal Cabinets and Bookcases..... 77
 Lateral File Tops..... 80
Working with Vertical Files 81
 Vertical Files 82

LAMINATE STORAGE

Working with Involve® Storage, Worksurfaces, Screens, and Powered Credenzas..... 83-115
 Pedestals, Credenzas, and Bookcases..... 116-127
 Soft Seating..... 128-129
 Storage Towers 130-134
 Stacking Storage 135
 Overheads, Shelves, Stanchions, and Hutches 136-141
 Worksurfaces — 18"D / Linear Taper / EZ View 142-145
 Worksurface Supports 146-147
 Screens..... 148-151
 Powered Credenzas 152-157
 Cubby Laminate Storage 158

VENEER STORAGE

Working with Align Veneer Storage..... 159-167
 Align Veneer Pedestals 168-170
 Align Veneer Personal Files and Towers 171-172
 Align Veneer Lateral Files 173-175
 Align Veneer Combination Files 176-178
 Align Bookcases and Accessories..... 179

APPENDIX AND INDEX

Locking Specification/Easy Lock 180-182
 16" x 20" Fabric Samples and Touch-Up Paint..... 183
 Replacement Parts Order Form 184
 Fabric Grades G-J and Upholstery Grades 9-23 185
 Index — Model Numbers with Page Reference..... 186-191
 Seating Upholstery for Involve 192-194
 Panel Fabrics Inside Back Cover

NEW PRODUCTS

Align™ Storage

Lockers 6/27/2016

Align Veneer Desking is supported with a Specification Guide and Price List PDF posted on Allsteel Synergy website.

Essentials™ Storage

18"D Pedestals — 7/6/2016

Extensions™

Power/Data Modules with USB ports — clamp on and under worksurface — 11/7/2016

Gather™

Gather provides a collection of collaboration solutions, from tables to seating, technology to space division. The Gather collection is located within the Seating, Collaboration, and Tables Price List.

NEW FINISHES AND FABRICS

Laminates — Branded Oak LBO1, Ebony Recon LER1, Fawn Cypress LFC1, Mangalore Mango LMM1, Phantom Charcoal LPC1 — 1/29/2017

Laminates — Lowell Ash LLA1, Natural Recon LNR1, Phantom Ecru LPE1, Portico Teak LPT1, Skyline Walnut LSW1 — 7/3/2016

Edges — Branded Oak BO, Ebony Recon DR, Fawn Cypress FC, Mangalore Mango MM, Phantom Charcoal PC — 1/29/2017

Edges — Lowell Ash DL, Natural Recon NR, Phantom Ecru PE, Plyband PL, Portico Teak DP, Skyline Walnut SW — 7/3/2016

Panel Fabrics — Refuge Eclipse RFG990 and Glacier RFG991 — 1/1/2017

Panel Fabrics — Appoint Panel Frost APN934, Reflections Galvanized REF929 and Ice REF920, Sarto Fog SRT914, Tempest Slate TP945 and Zebra TP935, Coast Channel COA914, Pebble COA912, and Pier COA913, Spin Panel with 14 colorways, Terrain with 9 colorways, and Script with 13 colorways. (All are listed on inside back cover) — 7/3/2016

Upholstery — Clyde 14 colorways, Rove 9 colorways, Hedge 5 colorways, Pocket 5 colorways, Verse 4 colorways, Ultraeather Pro 33 colorways, Fusion 5 colorways, Maze 15 colorways, and Chroma 4 colorways — 1/29/2017

DISCONTINUED PRODUCTS

Align Storage

Align Pedestal Hanging Frames and Box Drawer Divider 4/1/2016

Align Tower File Drawer Compressor 4/1/2016

Align 18¾"D Laminate and Veneer Tops 4/1/2016

Essentials Storage

Essentials 26¾"H Pedestals 4/1/2016

Touch-Up Paint

Accent Colors — all colors — 10/6/2016

DISCONTINUED FABRICS

Chatterbox, Tempo, Trisect, and Perennial upholstery — 12/15/2017

Tasanee panel fabric — 12/15/2017

Diode, Emery, Rift, and Seed SED05 Russet and SED01 Teal upholstery — 7/3/2016

Celestial panel fabric — 12/31/2016

Imprint, Jet Set, and Stagger panel fabric — 7/3/2016

Lifetime Warranty

Allsteel Inc. warrants its products to be free from defects in material and workmanship for as long as the original purchaser owns them, except as set forth below.

Allsteel shall repair or replace with comparable product (at Allsteel's discretion), free of charge, any Allsteel product or component manufactured after January 29, 2017, that fails under normal commercial office use.

This warranty is subject to the following provisions:

Some natural variations occurring in wood, leather, or other natural materials are inherent to their character and not considered defects. Allsteel does not warrant the colorfastness or matching of colors, grains, or textures of these materials. Additionally, a Customer's Own Material (COM) selected by, and used at the request of, a user is not warranted.

The materials and components listed below are covered according to the following schedule from the date of sale:

- Wood products and electrical components (lamps and ballasts are not covered), seating controls, pneumatic cylinders, glides, casters and polymer-based components, and foam — 12 years
- Wood seating, stacking chairs, Sum® AutoFit® technology, and laminates — 10 years
- User-adjustable worksurface mechanisms, tablet arm mechanisms, interior wood-framed seating and lounge products, occasional tables, Mimeo™ mesh, Quip™ mesh, Scout® mesh, panel and seating upholstery fabrics, and other covering materials — 5 years
- Marker board surfaces and upholstery on Gather™ products — 3 years
- #19®, Access™, Acuity®, Clarity®, Inspire®, Lyric™, Relate®, Scout, Seek®, Sum, and Trooper® asynchronous and synchro-tilt models are warranted for multiple shifts and users up to 300 lbs. Mimeo is warranted for multiple shifts and users up to 350 lbs. Lyric Large & Tall is warranted for multiple shifts and users up to 400 lbs. Trooper Large & Tall is warranted for multiple shifts and users up to 500 lbs. All other Allsteel chairs and components are warranted for single-shift, 40-hour workweek usage.

- #19 chair, including components and material, is warranted for as long as the original purchaser owns the chair.
- #19, Access, Acuity, Clarity, Lyric, Relate, and Seek mesh/carriers and Mimeo and Quip carriers are considered structural chair components and as such are warranted for as long as the original purchaser owns the chair.
- Undercabinet LED light — fixture warranted for 3 years; power supply warranted for 1 year
- Link™ LED light — 5 years
- Wand™ LED Light — fixture warranted for 5 years; power supply warranted for 3 years
- Beyond™ Movable Walls — 10 years; moving parts such as door hardware and door mechanisms — 5 years; customer's own hardware — supplier warranty

This warranty does not apply to:

- Normal wear and tear over the course of ownership, including fabric puddling
- Damage from sharp objects (e.g., writing utensils, heeled shoes, scissors, jewelry, keys)
- Modifications or attachments to the product not approved by Allsteel
- Products not installed, used, or maintained in accordance with product instructions and warnings
- Products used for rental purposes
- Damage caused by the carrier in-transit, which is handled under separate terms
- Third-party products. Allsteel, to the extent possible, will pass through to the original purchaser (and process claims under) any warranty provided by manufacturers of undercabinet lighting, ergonomic work tools, or other third-party products supplied by Allsteel.

TO THE EXTENT ALLOWED BY LAW, ALLSTEEL MAKES NO OTHER WARRANTY, EITHER EXPRESS OR IMPLIED, INCLUDING ANY WARRANTY OF MERCHANTABILITY OR FITNESS FOR A PARTICULAR PURPOSE. ALLSTEEL WILL NOT BE LIABLE FOR ANY CONSEQUENTIAL OR INCIDENTAL DAMAGES.

This warranty applies only to products sold within the United States of America and the Commonwealth of Canada.

Your Allsteel Dealer is our mutual partner in supporting your warranty requests. To obtain service under this warranty, please contact your Allsteel Dealer.

COM Program

Allsteel understands that customers may at times want to specify fabrics outside of Allsteel's standard fabric offering. Our COM program was designed to make specifying COMs on Allsteel products a simpler, friendlier, and hassle-free process. This process is simple and easy to use, and is described below under "Allsteel to Supply." If a Dealer wishes to manage the COM process themselves, they can do so by following guidelines under "Dealer to Supply". Find out more about Allsteel's COM process by emailing our COM Department at ASICSCOM@allsteeloffice.com.

Allsteel to Supply:

1. Select the fabric you wish to use and check the COM Search on Synergy. You need the COM supplier's name, fabric pattern name, and color name to search for approved fabrics.
2. If your fabric is listed as an approved fabric, you may place your order directly with Allsteel Customer Support. Please use the fabric code (e.g., S216426XP) from the COM Test Request on your order in the place of the standard fabric code. **Make sure to mark on the top of the order "Allsteel to Supply."** If your fabric is not listed as approved, you will need to select the "Request COM Test" link on the COM Search website. Allsteel will arrange to obtain test fabric and you will be notified of the results within 3 to 5 working days of receipt of the test yardage by Allsteel.
3. If the fabric is approved, you will receive an email summary from Allsteel with the correct price grade and fabric code for order purposes. Written COM price quotes hold pricing for 90 days after issue date.
4. Once the fabric has been approved by Allsteel, enter your order directly with Allsteel Customer Support. Allsteel will purchase all COM fabric directly from the COM suppliers and schedule for production.

In the event that the Dealer decides to cancel a COM fabric order, the Dealer is responsible for the cost of the fabric plus a handling charge that is equal to 10% of the fabric cost.

Dealer to Supply:

1. Select the fabric you wish to use and check the COM Search on Synergy or call Allsteel Customer Support to see if the fabric you have chosen has already been tested and approved on the product you are interested in.

You need to have the COM supplier's name, fabric pattern name, and color name for this inquiry.
2. If your fabric is listed as approved, and it is not a Partnership fabric, you may request a "Dealer to Supply" code and estimate the yardage required by using the yardage requirements listed in the price list by model. For questions please contact Allsteel Customer Support.

3. If your fabric is not listed as already tested and approved, you will need to complete a COM Test Request on Synergy. You will need to arrange for the test fabric to be sent to:

HNI Fabric Testing
Attn: COM Dept.
2210 2nd Avenue
Muscatine, IA 52761

Allsteel requires 3 yards of fabric and 2 memo samples for each panel system fabric being tested; and 4 - 8" x 8" memo samples for all seating testing. You will be notified of the test results within 3 to 5 working days of receipt of the test yardage by Allsteel.

4. Make sure to use a "Dealer to Supply" COM code (e.g., S216426ZP) and place your order directly with Allsteel Customer Support.
5. All "Dealer to Supply" orders will be charged Grade 4 pricing for seating, Grade 3 for Gather, and Grade D pricing for panels. Dealers will pay for the COM fabric separately.
6. All "Dealer to Supply" fabric must be sent on a fabric roll.
7. Place your fabric order directly with the COM Supplier with instructions for the fabric to be sent on a fabric roll to:

HNI Fabric Distribution Center — Dealer PO Number
COM Production Yardage
Docks 20-22
200 Oak Street
Muscatine, IA 52761

Information that **MUST** be included in the packing slip attached to the fabric:

1. Dealer's Purchase Order number to Allsteel
2. Allsteel's Tracking number for the COM fabric
3. Dealer Name
4. Yards of Fabric

If the fabric shipment does not match the correct fabric and yardage, Allsteel will notify the Dealer for resolution.

If Allsteel receives fabric with incorrect labeling that cannot be linked to an Allsteel furniture order, Allsteel will hold the fabric for up to 7 days, while the COM Expeditor attempts to identify the order. After 7 days, Allsteel will return the fabric to sender. There are no exceptions to this policy.

Any cancelled orders are subject to cancellation charges up to the full value of the Allsteel product cancelled. Allsteel will determine the actual cancellation charge at the time the cancellation is requested.

8. For additional details on "Dealer to Supply" fabric refer to your Allsteel terms and conditions.

Additional Policy Information:

The company assumes no responsibility for the overall appearance, flammability, normal durability, colorfastness, or any other quality standards. The Company reserves the right to reject a COM if the quality of the COM is not satisfactory for the product. Should this occur, the customer will be notified with an explanation within 7 working days of receipt of test materials.

The company is not responsible for fabric that has become obsolete at the COM supplier, that is of poor quality, or that is delivered late to the manufacturer from the COM supplier. Excess yardage will be disposed of at Allsteel’s discretion.

All cancellations or changes to COM orders are subject to Company approval. Because of the nature of COM, special fabrics, finishes, and structural modifications, products ordered as specials and then cancelled prior to shipment are subject to cancellation costs up to the full value of the product cancelled. The company determines the actual cancellation charge at the time the cancellation is requested. Upon approval, a cancellation number is issued to the Customer.

Purchase orders will not be accepted or entered unless the testing process is complete with positive results.

If all testing has been previously completed, re-testing is only necessary if fabric is to be used on a different product, or pattern direction has changed from that previously approved.

Previous test results can be obtained by a customer on the COM Search on Synergy or by calling Allsteel Customer Support. COM testing will require 3-5 working days from receipt of test yardage.

COM testing will require 3-5 working days from receipt of test yardage.

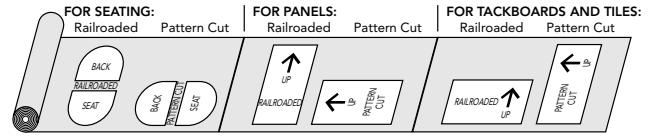

All COM fabric will be applied to seating and panel systems Pattern Cut unless Railroad Cut is requested and approved on the COM Test Request. Any fabrics approved as a width pass, the dealer is responsible for clarifying Railroad Cut on orders containing items that are too large to support the Pattern Cut of a fabric application (any items larger than 48" high or wide).

Fire Retardant

The Dealer is responsible for ensuring that the COM fabric is certified to meet all flame retardant requirements.

For more information, please contact Allsteel Customer Support.

YARDAGE REQUIREMENTS FOR FABRIC WITH REPEATS — FOR USE ON GATHER™ PRODUCTS

Fabric Width	Plain Fabric	2"– 14" Repeat	15"– 19" Repeat	20"– 27" Repeat	28"– 36" Repeat
54"	0	+15%	+20%	+25%	+30%
53"	+6%	+19%	+24%	+28%	+36%
52"	+13%	+23%	+28%	+33%	+38%
51"	+19%	+26%	+31%	+36%	+41%
50"	+25%	+30%	+35%	+40%	+45%
49"	+30%	+35%	+40%	+45%	+50%
48"	+35%	+40%	+45%	+50%	+55%
47"	+45%	+50%	+55%	+58%	+65%

Depending upon the pattern repeat, it may be necessary to pattern cut the fabric. This will require 10% additional fabric.

To calculate multiple repeats (vertical and horizontal), add each repeat for total yardage required. For example for a fabric width of 54": 7" vertical requires 15%, 15" horizontal requires 20% total additional yardage required equals 35% (15% + 20%). Therefore, if your chair requires 2 yards of fabric, multiply 2 by 35%. Then 2.7 yards will be yardage required.

Special Paint & Stain Policy

Allsteel at its own discretion may modify its standard products with non-standard paint and stain colors to meet specific needs. Dealer is required to submit a special paint or stain request via the COM Search on Synergy. A sample of the non-standard paint or stain color desired will be required for matching. Pricing, lead time, and order information will be provided at the time of approval.

- For each new requested stain or paint, there will be a \$500 net fee to cover supplier costs to match the special item.
- For existing, previously-approved stains or paints, there is no \$500 matching fee, however, there is a sample chip fee of \$175 net for stains and \$100 net for paints.
- Samples, preferably at least 3" x 5" chips, of the exact color desired should be sent to the Allsteel Tailored Products Group. Paint matches require (3) sample chips and stain matches require (3) sample chips. Please mail these sample chips to the address below and reference the Special Item Request Number from Tailored Solutions.

Allsteel Inc.

Attn: Tailored Products Group
2210 Second Avenue
Muscatine, IA 52761

- Allsteel will color match the sample and send control samples to the address provided in the request. Dealer will review Allsteel's color match and approve by signing the back of the sample chip. Send the signed sample back to the Allsteel Tailored Products Group.
- Special paints will be assigned a paint price grade.
- Orders will not be accepted until Allsteel receives the Dealer's written approval on the color match.
- Extended lead times will apply on orders containing special paints or stains.
- Due to manufacturing techniques, materials, and quality issues, some exclusions will apply and some matches may be declined.

Important Notes

- Natural veneer is subject to nature's quality control. Differences in grain and color are naturally occurring variations and cannot be controlled by the manufacturer and cannot be considered as product defects. Natural veneer has the characteristics and beauty of a living organism; with its own variations of grain, growth, and color patterns. For these reasons, Natural veneer is preferred by many for its warmth and personal characteristics.
- Color changes will occur over time when wood is exposed to light. For this reason, when new product is ordered as an addition to existing product, there will be color variances between the old and new product. Please remember when specifying new product that although the species of veneer will be the same, additional product is being manufactured from a different tree. It may take several months for the new furniture to mature to the color level of existing product. Even with this maturation process the additional product will not be an exact match.

Special Laminate Policy

The Company at its own discretion may modify its standard products with non-standard laminates to meet specific needs. Contact the Allsteel Tailored Products Group for pre-approved Wilson Art laminates and pricing for special laminates. When requesting a special laminate please supply manufacturer, along with name and pattern number of laminate.

- Extended lead times will apply on orders containing special laminates.
- Due to manufacturing techniques, materials, and quality issues, some product exclusions will apply and some requests may be declined.

Veneer Care Instructions

Veneer worksurfaces feature the Gunlocke® finishing system. The finishing system is a process that begins with the application of stains, which promote exceptional depth and clarity. Next the worksurface receives a specialized coating that provides exceptional durability and chemical resistance. The remaining surfaces receive a top coat. These finishing processes ensure depth, clarity, color consistency and durability throughout the product.

Veneer worksurfaces have exceptional resistance to:

- Heat and moisture (hot beverages, pizza boxes)
- Chemicals (liquid paper, nail polish)
- Stains (permanent markers)
- Scratches and impact (everyday wear and tear)

Caring for your veneer finish:

- General maintenance procedures entail wiping clean the entire surface with a clean, water dampened soft cloth once per week (be sure to wipe with the grain)
- Murphy's® Oil Soap may be used as a general purpose type cleaner with warm water to clean tops.
- The finish may also be polished with Guardsman® Furniture Polish (contains no waxes or silicones) to provide renewed luster.
- Be sure to wipe up all spills immediately. Do not allow spills to dry.

Wood owes its inherent beauty to variations in color, grain and texture, and therefore, these variations are not considered defects. There may be minor variations from one piece of furniture to the next even though they are finished at the same time. Exposure to light and the aging process will cause a darkening of natural wood products. Light finishes on wood products do not mask the natural characteristics of wood. Allsteel does not guarantee the exact matching of grain, pattern and color.

Everyday Advantage®

Program Terms for Everyday Advantage

1. Orders must clearly state “Everyday Advantage Order” and include the appropriate Everyday Advantage contract number:
 - Everyday Concensys® Std-0131, Everyday Concensys Canada-0133
 - Everyday Optimize™/Terrace® Std-0125, Everyday Optimize/Terrace Canada-0127
 - Everyday Concensys Gov-0132
2. Orders must contain only Everyday Advantage products. Choose the correct contract in your electronic ordering system by selecting the panel system, (Concensys or Optimize/Terrace) then add other desired products. If no systems product is being ordered, either contract can be selected.
3. Everyday Advantage orders are not eligible for bid pricing.
4. The complete Concensys, Optimize, and Terrace systems lines. This program also includes Access™, Inspire®, Lyric™, Mimeo™, Nimble®, Quip™, Relate®, Seek®, Scout®, Sum®, Tolleson, and Trooper® seating. Altitude®, Aware®, and Merge® tables are available, along with Align™ Lockers and metal storage, and the complete Essentials™ storage line. In addition, Extensions™ ergonomic accessories and lighting are part of the offering.
5. Orders received for the program must only contain Everyday Advantage identified product. Products included in an order that are not part of the program will cause the whole order to be acknowledged as regularly manufactured products.
6. All textiles and finishes are available, but some may have extended lead times.
7. Everyday Advantage orders are not limited to a minimum or maximum.
8. All orders ship based on standard lead times. Large-quantity orders of like products may be subject to longer lead times.
9. Standard freight terms apply.
10. If driver assistance is needed, standard driver assist charges will be added at time of order entry.

Allsteel Inc. reserves the right to amend or terminate this program at any time with 30 days written notice. Allsteel is not liable for service delays caused by force majeure (circumstances beyond Allsteel's control).

Storage is an essential part of the productive workplace.

Make storage a matter of personal choice as well as necessity. Choose from metal, laminate, or veneer with features like multiple pull styles, drawer sizes, finishes, and more. It's your workspace. Shouldn't it look like it?

PERSONAL STORAGE





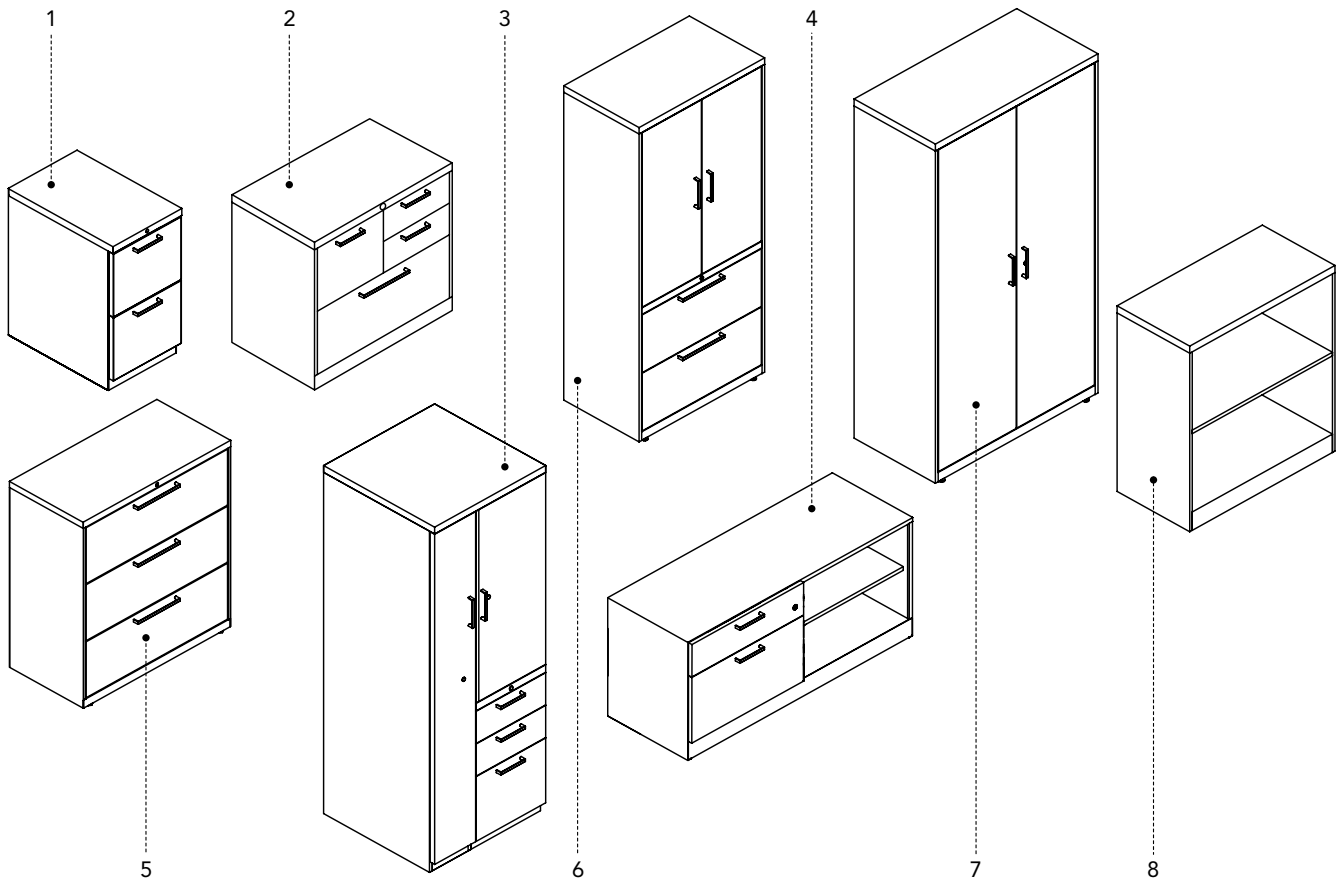

- 1. Pedestal.**
Support, mobile, or suspended, with three drawer sizes.
- 2. Personal file.**
Combines pedestal and lateral storage to create a personal filing solution for letter and legal size documents.

- 3. Personal tower.**
Versatile storage with a small footprint. It's storage that goes up, not out. Combine drawers, personal storage, and wardrobe options for the right solution.
- 4. Low credenza.**
Active storage that creates a layered look in any workspace.

LATERALS AND SHARED STORAGE

- 5. Lateral file.**
The storage workhorse, in multiple heights and widths. Works with systems furniture or by itself.
- 6. Combination file.**
The perfect combination of file storage and shelf storage, with concealed or open shelves.
- 7. Storage cabinet.**
Equipped with hinged, locking doors and adjustable shelves to conceal and secure supplies.
- 8. Bookcases.**
Quick access to information, in depths to match laterals or narrower profiles to stand on their own.



STORAGE SOLUTIONS	PULL OPTIONS AVAILABLE							
	Straight	Arch	Square	"J"	Integral	Beveled	Linear	No Pull
Pull Letter Designator:	H	A	S	J	I	B	(None)	
Pull Reference: <i>(Pedestal Drawer Fronts)</i>								
Personal Storage								
Align All Metal Pedestals	•	•	•		•	•		
Align Metal Pedestal w/Laminate fronts	•	•	•					
Align Metal Low Storage	•	•	•		•	•		
Align Metal Low Storage w/Laminate fronts	•	•	•					
Align 24"W Metal Towers	•	•	•		•	•		
Align 12"W Metal Towers	•	•	•					
Align Metal Lockers	•	•	•		•			
Align Metal Lockers with Laminate fronts	•	•	•					
Align Metal Towers w/Laminate fronts	•	•	•					
Align All Veneer Pedestals		•	•	•				
Align Veneer Pedestals with Landscape fronts		•	•					
Align All Veneer Personal Files		•	•	•				
Align All Veneer Towers		•	•	•				
Essentials Pedestals		•	•		•	•		
Essentials Personal Files		•	•		•	•		
Essentials Personal Towers		•	•		•	•		
Hutches								
Align Veneer Hutch w/hinged doors								•
Align Veneer Hutch w/Landscape hinged doors								•
Universal Hutch w/flipper door		•	•					•
Overheads								
All Metal Overhead w/flipper door		•	•					•
All Metal Overhead w/hinged doors		•	•					•
All Metal Overhead w/single sliding door								•
All Metal Overhead w/recessed door		•	•					•
RTA Overhead w/flipper door								•
Align All Veneer Overhead w/hinged doors								•
Laterals and Shared Storage								
Align™ All Metal Laterals	•	•	•		•	•		
Align Metal Lateral w/Laminate Fronts	•	•	•					
Align All Veneer Laterals		•	•	•				
Align Veneer Laterals w/Landscape fronts		•	•					
Align Veneer Combination Files		•	•	•				
Align Veneer Combination Files w/Landscape fronts (hinged doors)		•	•					
Align All Veneer Bookcases <i>(no pulls required)</i>								•
Essentials™ Laterals		•	•		•	•		
Essentials Combination Files		•	•		•	•		
Essentials Storage Cabinets		•	•		•	•		
Essentials Bookcases <i>(no pulls required)</i>								•
Essentials Overfile								•

Align Metal Pedestals — support or mobile



File/File
28½"H x 15"W
18", 23¼", 29¼"D



Box/Box/File
28½"H x 15"W
18", 23¼", 29¼"D



File/File
26½"H x 15"W
18", 23¼", 29¼"D



Box/Box/File
26½"H x 15"W
18", 23¼", 29¼"D



Box/File
20½"H Mobile,
22"H Freestanding
18", 23¼", 29¼"D x 15"W

Plinth base shown, models available with Stride or Terrace feet. Choice of metal or laminate fronts.

Align Low Metal Storage — credenzas, right and left configurations available

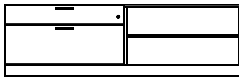

Box/Lateral/Open
72"W
22"H x 18", 24"D

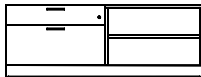

Box/Lateral/Open
60"W
22"H x 18", 24"D

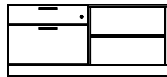

Box/Lateral/Open
48"W
22"H x 18", 24"D

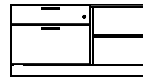

Box/Lateral/Open
42"W
22"H x 18", 24"D

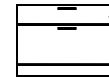

Box/Lateral
24", 30", 36", 42"W
22"H x 18", 24"D

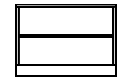

Open
24", 30", 36", 42"W
22"H x 18", 24"D

Plinth base shown, models available with Stride or Terrace feet. Choice of metal or laminate fronts.

Align Metal Lateral Files



2-High
28"H
30", 36", 42"W
18"D

Plinth base shown, models available with Stride or Terrace feet. Choice of metal or laminate fronts.

Align Metal Personal Towers and Lockers — Stride®/Terrace®/Optimize™ Height — left configuration shown, also available right

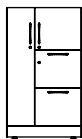

42½"H
24"W x 24"D



50"H
24"W x 24"D

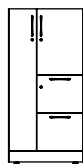

57½"H
24"W x 24"D

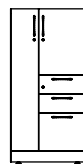

65"H
24"W x 24"D

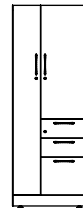
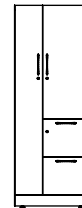
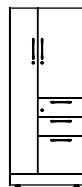
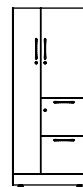

Plinth base shown, models available with Stride or Terrace feet. Choice of metal or laminate fronts.

Align Lockers — Overview — Left configurations shown, also available right

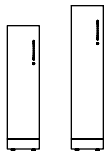

Single 12"W
42½", 50"H / 18", 24"D



Double 12"W
57", 65"H / 18", 24"D

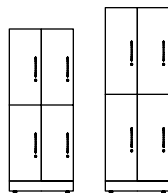

Quad 24"W
57", 65"H / 18", 24"D

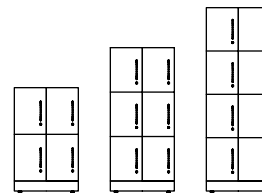

Cubby 24"W
35", 50", 65"H / 18"D

Plinth base shown, models available with Stride or Terrace feet. Choice of metal or laminate fronts.

Essentials Pedestals — Ball-Bearing Slides

Support



File/File
28"H x 15"W
18", 19", 22", 28"D



Box/Box/File
28"H x 15"W
18", 19", 22", 28"D

Suspended



Box/File
19½"H x 15"W
18", 19", 22"D

Basic Support



File/File
28" x 15"W
19", 22"



Box/Box/File
28"H x 15"W
19", 22"

Mobile



File/File
28"H x 15"W
18", 19", 22", 28"D



Box/Box/File
28"H x 15"W
18", 19", 22", 28"D



Box/File
22½"H x 15"W
22"D

Basic Mobile



File/File
28"H x 15"W
19", 22"



Box/Box/File
28"H x 15"W
19", 22"

Essentials Personal File

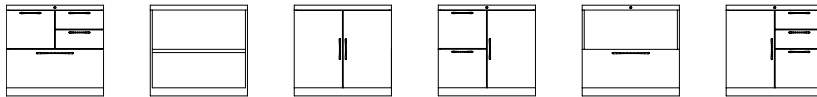

28"H x 18"D x 30"W
Left and Right door configurations available

Essentials Personal Towers

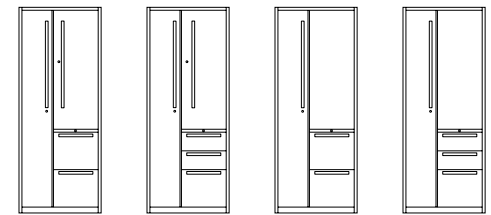

50"H, 65"H x 24"D x 24"W
Left and Right door or open side shelf configurations available

Essentials Lateral Files

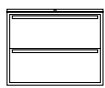

2-High
27¾"H
30", 36", 42"W
18"D

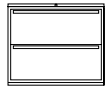

2-High
28"H
30", 36", 42"W
18"D



3-High
39¾"H
30", 36", 42"W
18"D

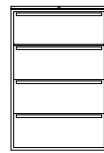

4-High
52½"H
30", 36", 42"W
18"D

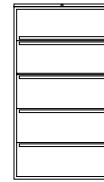

5-High
64¾"H
30", 36", 42"W
18"D

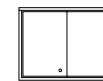

Sliding Doors
27¾"H
30", 36", 42"W
18"D

Essentials Combination Files



Without Doors
64¾"H
30", 36"W
18"D

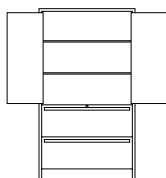

Hinged Doors
64¾"H
30", 36"W
18"D

Essentials Cabinets

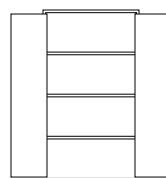

Hinged Doors
39¾", 64¾"H
36"W
18"D

Essentials Bookcases

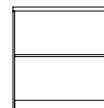

39¾"H
36"W
18"D

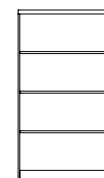

64¾"H
36"W
18"D



29", 41", 59",
71", 81"H
34½"W
12¾"D

Leg or Plinth Base models available. Leg base units are shown below. *Indicates power ready models available.

Pedestals — 24"H and 28"H



Mobile
Box/File



Freestanding
Box/File



Freestanding
Open



Support
Box/Box/File



Support
File/File



Support
Open

Credenzas — 17½"H, left- and right-handed models available for handed units.



Single Lateral



Single Lateral
w/Open Cubby



Corner Table

Credenzas — 24"H, left- and right-handed models available for handed units.



Box/Lateral



Box/Box
Lateral

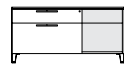

Box/Lateral
w/Open Cubby*



Sliding Door
Open*



Open*

Credenzas — 28"H, left- and right-handed models available for handed units.



2-High
Lateral



Box/Box
Lateral



Box/Box
Project/Lateral



Sliding Door
Open w/Cubbies*



Open*

Credenzas and Bookcase — 42"H



3-High
Lateral

Bookcases — 65"H and 72½"H



Bookcase
w/Lateral

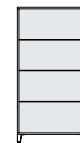

Bookcase

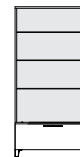

Bookcase
w/Lateral

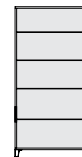

Bookcase

Towers — 42"H (12"W only), 50"H and 57½"H (50"H shown); left- and right-handed models available.

12"W



Full-Width Door

18"W



Hinged Door
Box/Box/File

18"W



Side Access
File/File

24"W



Hinged Door
Box/Box/File

24"W

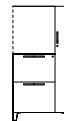

Side Access
File/File

Towers — 65"H and 72½"H (65"H shown); left- and right-handed models available.

12"W



Full-Width Door
(65"H)

18"W



Hinged Door
Box/Box/File

18"W



Hinged Door
File/File

18"W



Full-Width
Door

24"W

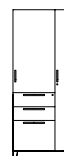

Hinged Door
Box/Box/File

24"W

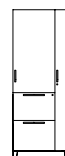

Hinged Door
File/File

24"W



Full-Width Door

Leg or Plinth Base models available. Leg base units are shown below.

Stacking Storage — Hinged Door, left- and right-handed models available

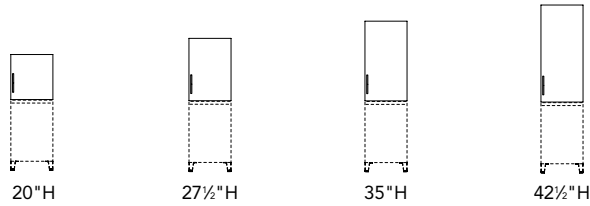

Stacking Storage — Open

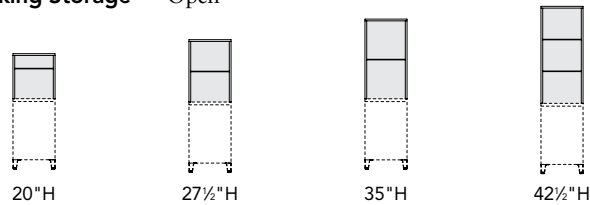

Overheads and Shelves

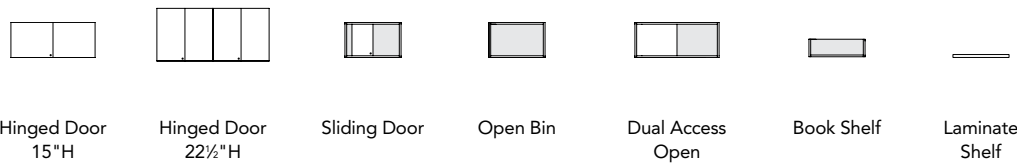

Soft Seating and Tables

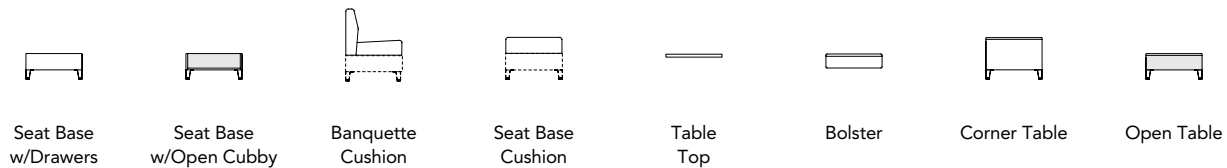

Worksurfaces — New shapes added for Involve to the hundreds available in our existing Worksurface selection.

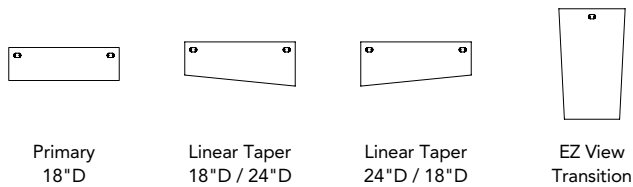

Supports and Accessories

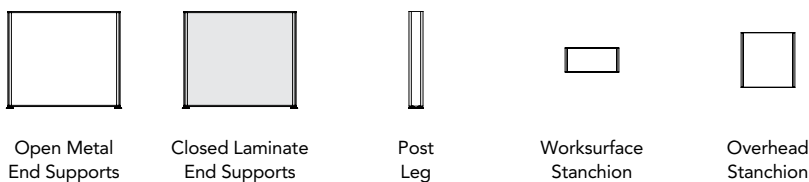

Modesty Panels and Screens

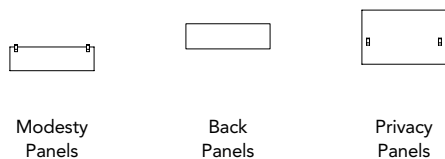

Accessories

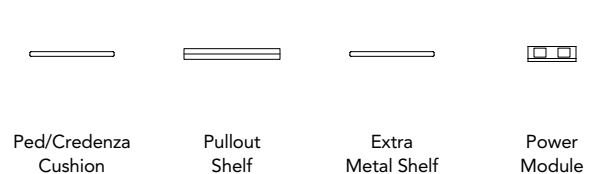

Align Veneer Pedestals — support or mobile, also available with Landscape™ fronts



File/File
28½"H x 15½"W
24", 30"D



Box/Box/File
28½"H x 15½"W
24", 30"D



File/File
26½"H x 15½"W
24", 30"D



Box/Box/File
26½"H x 15½"W
24", 30"D



Box/File
20½"H x 15½"W
24", 30"D

Align Veneer Personal Files



Box/Box/File / Lateral
27½"H x 30"W
20"D

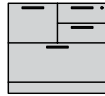

File/Box/Box / Lateral
27½"H x 30"W
20"D

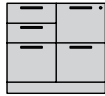

Box/Box/File / File/File
27½"H x 30"W
20"D

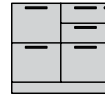

File/Box/Box / File/File
27½"H x 30"W
20"D

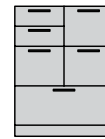

Box/Box/File / File/File / Lateral
39½"H x 30"W
20"D



File/Box/Box / File/File / Lateral
39½"H x 30"W
20"D

Align Veneer Personal Towers

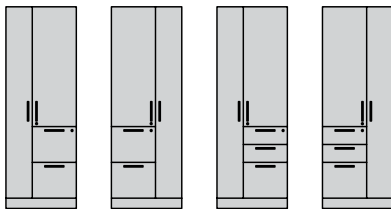

5-High
67½"H x 24"W / 24"D

Align Veneer Lateral Files — 2H and 5H also available with Landscape fronts



2-High
27½"H
30", 36"W
20"D



3-High
39½"H
30", 36"W
20"D



4-High
51½"H
30", 36"W
20"D



5-High
67½"H
30", 36"W
20"D

Align Veneer Combination Files — also available with Landscape fronts



Hinged Doors
4-High
51½"H
30", 36"W
20"D

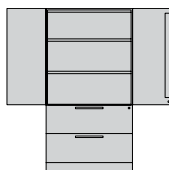

Hinged Doors
5-High
67½"H
30", 36"W
20", 24"D



Without Doors
4-High
51½"H
30", 36"W
20"D



Without Doors
5-High
67½"H
30", 36"W
20"D

Align Veneer Bookcases

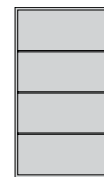

3-, 4-, 5-High
39½", 51½", 67½"H
30", 36"W
20"D

Align™ Metal Storage

Storage Overview	10
Pull Option Matrix.....	11
Align Metal Statement of Line.....	12
<i>Working With Align Metal Storage — Specification Information</i>	
Working with Align™ Storage	17-21
Align Storage Dimensions and Filing Capacities	22-25
Working with Align Pedestals.....	26-27
Working with Align Credenzas.....	28-30
Working with Align Storage Tops.....	31
Working with Align Lateral Files.....	31
Working with Align Towers	32
Working with Align Lockers.....	33
<i>Align Metal Case Storage — Pricing Information</i>	
Support and Mobile Pedestals	34-35
Pedestals with Stride or Terrace Feet	36
Accessories and Pedestal Tops for Align	37
Low Metal Storage and Accessories	38-43
Lateral Files and Accessories	44
Tops for Align Metal Storage	45
Personal Towers and Accessories.....	46-49
Lockers, Wardrobes, and Accessories	50-58

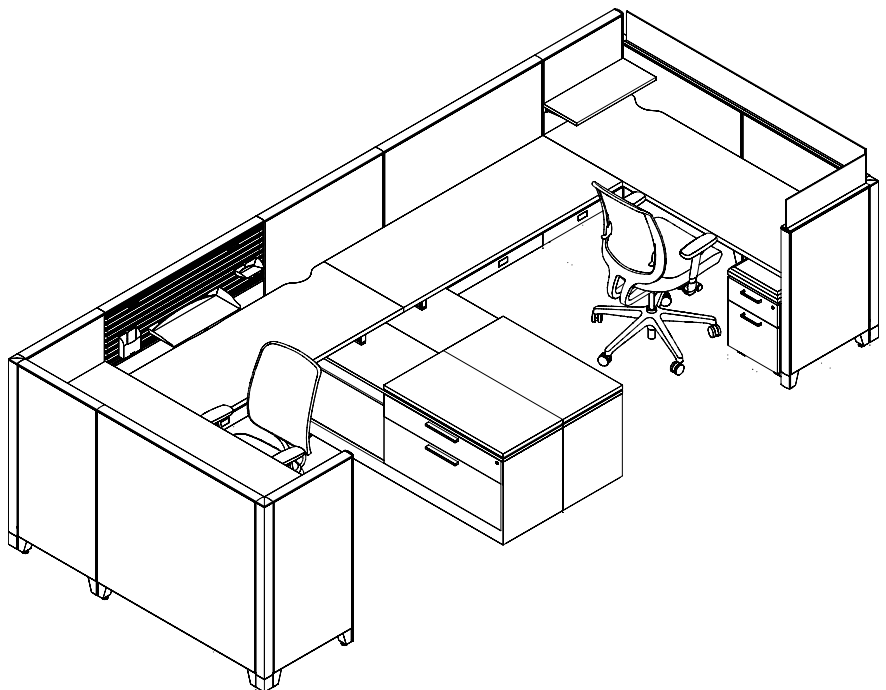

"O" Frame Construction

Heavy duty outer shell and front and rear perimeter frames provides significant strength; helps keep the cabinet true to square.

File and Box Drawers

Full extension file and box drawers glide easily on steel ball-bearing suspensions; allows complete access to drawer contents with a quiet drawer motion.

Double-Wall Drawer Front

Drawer fronts are fully lined to reduce noise and to prevent damage from drawer contents.

Filing

File drawers can accommodate front-to-back and side-to-side filing. Order hanging frames separately.

Full Front Drawer Design

Drawer front is square and extends fully across the case.

Counterweight

Counterweights (standard on mobile pedestal units) inhibit tipping when drawers are opened. Optional counterweight kits.

Aesthetic Alignment

Drawer alignment matches across Align storage offering. Base height matches Stride® and Terrace® panel base.

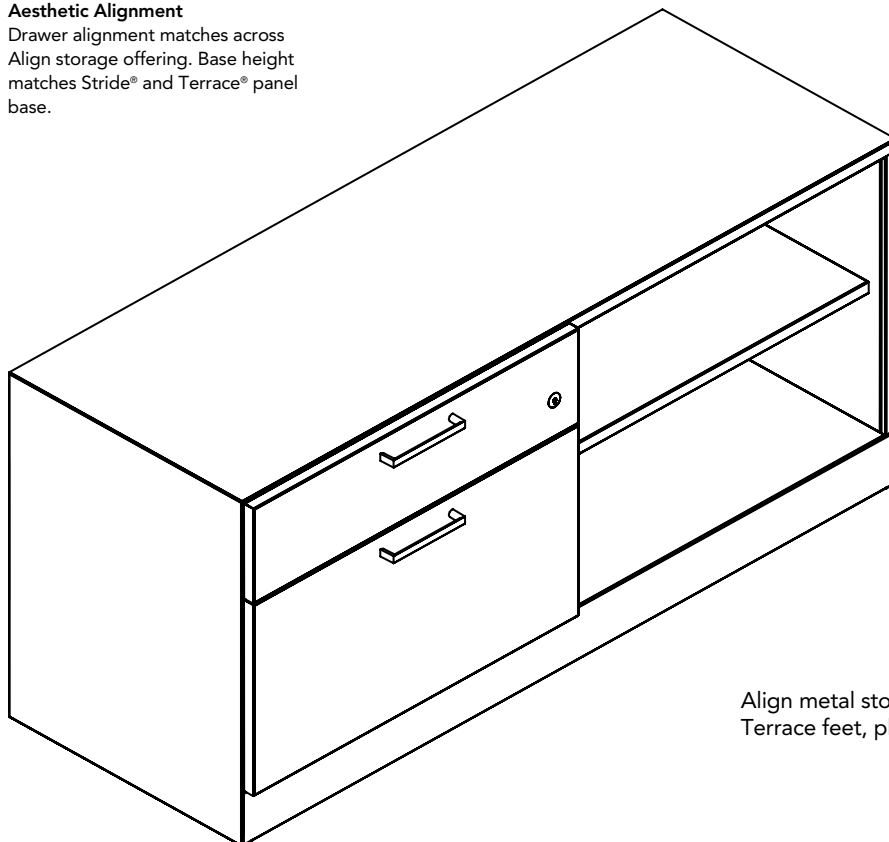
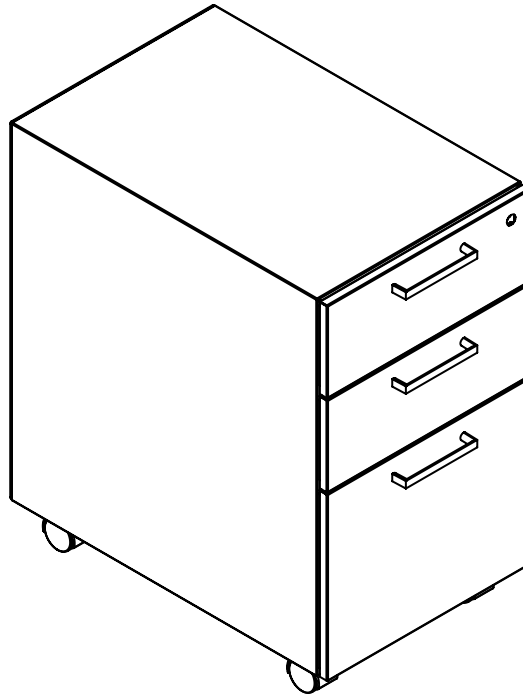
**Locking System**

Robust lock system for security and reliability.

Core Removable Locks

Master-keyed core removable lock feature allows key numbers to be easily changed in the field and facilitates one-key access.

Omit Lock Core

Units can be shipped with lock cores removed; cores can then be installed after units are placed. Different storage components can be keyed alike within a workstation.

Mobile Pedestals

Mobile pedestals provide flexible storage and can be nested under worksurfaces. (Take into consideration when planning offices which may have uneven floors.)

Support Pedestals

Support pedestals can support one end of a panel-attached worksurface, in lieu of other worksurface supports, and can be used to support worksurfaces in desking applications. Drawers align with laterals.

Freestanding Pedestals

Freestanding pedestal drawers align with credenzas.

Depth

Pedestals are 18", 23¼", and 29¼"D, and credenzas are 18" and 24"D, both can be used with systems worksurfaces. Placement may affect access to receptacles in base pathway and worksurface grommets.

Pull Styles

Choice of pull styles, available on pedestals, credenzas, towers, and laterals, allows for total design coordination on projects.

Veneer and Landscape Fronts

Contact Allsteel Tailored Products Group for availability.

Align metal storage models are available with Stride or Terrace feet, plus laminate front option.

Seven-formation

Front Post Design

Steel front posts are formed with seven formations to provide unparalleled stability and strength. This unique design allows unmatched longevity for Allsteel files.

Dual-side Locking

Drawers and doors lock on both sides to prevent being pried open. The locking system is enclosed within the case to hide mechanisms which can snag and scratch. This feature is not found on most other manufacturers' files.

Dual Interlock

This mechanism inhibits roll out of more than one drawer, either sequentially or simultaneously.

Adjustable Drawer Backs

Backs are adjustable to three depths to accommodate letter, A4, and legal documents side to side without the need for extra components.

Infinitely Adjustable Divider

This Allsteel exclusive design allows the divider to also function as a compressor in that it can be located where it is needed versus being limited to pre-set positions.

Offset Construction

As a result of the back and the top of the case sides being offset, the file case has a finished appearance with smooth seams and no overlaps.

Fully Enclosed Bottom

Unlike many files, the Allsteel file features a fully enclosed steel bottom to help prevent moisture and dust from affecting the filed documents. Double bottoms are welded into all files for added rigidity.

Side Knockouts

Files have two knockouts on each side to allow easy ganging of freestanding units to inhibit tipping.

Four Hex-head Leveling Glides

Leveling glides can be adjusted from outside or inside the case. Because of the hex-head design of the stem, leveling can be done even when the file is fully loaded. Range is 1½".

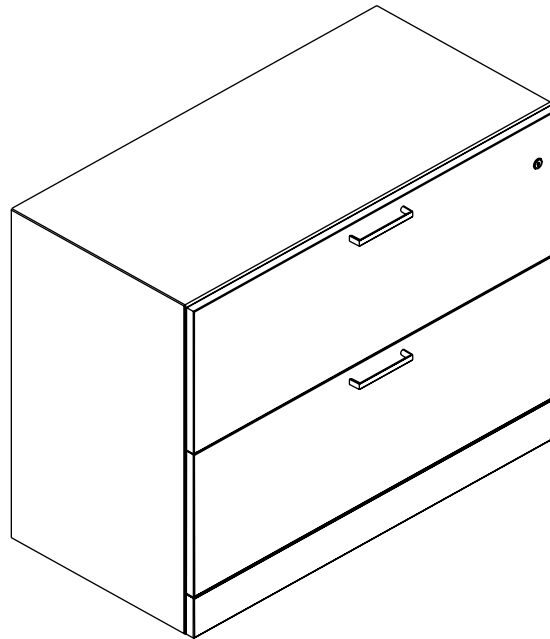

Suspension

Extra heavy-duty, telescoping, ball-bearing slides.

Hanging Frames

Front-to-back and side-to-side are both standard. For front-to-back filing, backs should be set on rear position for maximum storage capacity.

Core Removable Lock

Core removable lock feature allows key numbers to be easily changed in the field. It also facilitates installation.

Omit Lock Core

Files can be shipped with lock cores removed; cores can then be installed after files are placed. Laterals can be keyed alike with pedestals, laterals, credenzas, towers, and overhead cabinets.

Full Front Drawer Style

Features core removable lock located in top drawer on the right.

Front Drawer Options

Optional veneer and Landscape™ fronts available on laterals, contact Allsteel Tailored Products Group.

Pull Styles

Choice of five pull styles, also available on pedestals, credenzas, and towers, allows for total design coordination on projects.

Double-wall Drawer Front Construction

Drawer fronts are fully lined to reduce noise and to prevent damage from drawer contents.

Counterweight Kit

The unique design of the counterweight allows easy installation because, unlike some files, the drawers and shelves in Allsteel files do not have to be removed to install the required counterweights.

Drawer Interiors

Painted same color as case.

Paint Finish

Durable baked enamel finish is applied over rust-inhibiting phosphate pre-treatment.

Align™ Metal Storage

Working with Towers

GSA Reference Page

Offset Construction

As a result of the back and the top of the case sides being offset, the file case has a finished appearance with smooth seams and no overlaps.

Fully Enclosed Bottom

Double bottoms are welded into all files for added rigidity.

Four Hex-head Leveling Glides

Leveling glides can be adjusted from outside or inside the case. Because of the hex-head design of the stem, leveling can be done even when the file is fully loaded. Range is 2¾".

Double-Wall Drawer Front Construction

Drawer fronts are fully lined to reduce noise and to prevent damage from drawer contents.

Aesthetic Alignment

Drawer alignment matches other Align storage.

Full Front Design

Drawer and door fronts extend fully across the case.

Pull Styles

Choice of pull styles allows for total design coordination on projects.

Suspension

Heavy-duty, telescoping ball-bearing slides.

Omit Lock Core

Units can be shipped with lock cores removed; cores can then be installed after storage units are placed. Laterals can be keyed alike with pedestals, towers, and overhead cabinets.

Paint Finish

Durable baked enamel finish is applied over rust-inhibiting phosphate pre-treatment.

Core Removable Locks

Core removable lock feature allows key numbers to be easily changed in the field. It also facilitates installation.

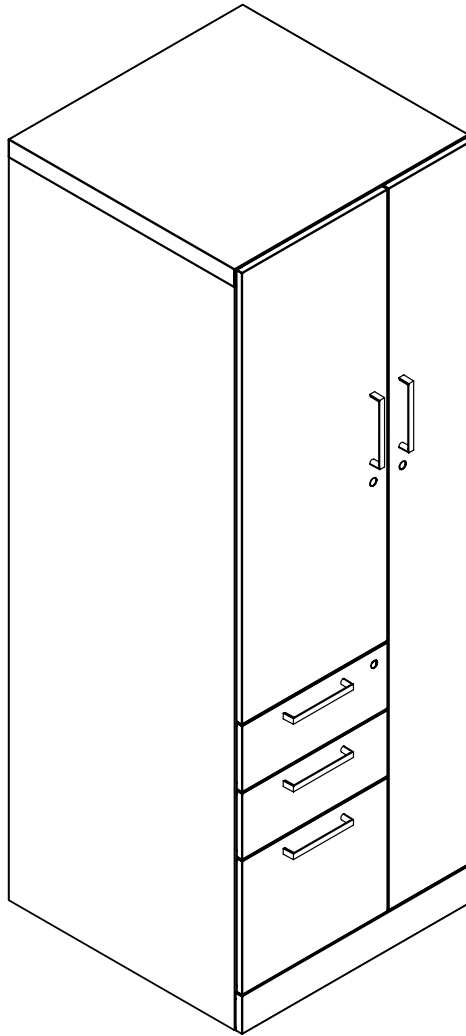

Align Personal Tower

Locking

Three locks secure doors and drawers on front access towers; two locks on side access towers.

European Hinges

Wardrobe and cabinet door both contain European-style hinged door.

Filing

File drawers can accommodate front-to-back and side-to-side filing. Order hanging frames separately. Hanging frames are compatible with metal case/metal front and metal case/wood front models.

Interior Dimensions for Credenzas

Description	Height	Depth	Width	
CREDENZAS	Open	22"H – 17¼"	18"D — 17½" – 17" interior Shelf 15¼"	24" exterior – 22½" interior 30" exterior – 28½" interior
		1 Adj. Shelf ¾"	24"D — 23⅝" – 23" interior Shelf 21¼"	36" exterior – 34½" interior 42" exterior – 40½" interior
		8¼" Shelf 8¼"		
		or 12" Shelf 4½"		
	Box/Lateral	Box – 3⅝"	Box – 13¼"	24" exterior – 21" interior 30" exterior – 27" interior 36" exterior – 33" interior
		Lateral – 10½"	18"D — Lateral – 13¼"	24" exterior – 20½" interior
			24"D — Lateral – 15½"	30" exterior – 26½" interior 36" exterior – 32½" interior
	Box/Lateral w/Open Side	Box – 3⅝"	Box – 13¼"	42" exterior – 21" interior 48" exterior – 21" interior 60" exterior – 27" interior 72" exterior – 33" interior
		Lateral – 10½"	18"D — Lateral – 13¼"	42" exterior – 20½" interior
			24"D — Lateral – 15½"	48" exterior – 20½" interior 60" exterior – 26½" interior 72" exterior – 32½" interior
Open – 17¼"		18"D — 17½" – 17" interior Shelf 15¼"	42" exterior – 16½" interior	
1 Adj. Shelf ¾"		24"D — 23⅝" – 23" interior Shelf 21¼"	48" exterior – 22½" interior 60" exterior – 28½" interior 72" exterior – 34½" interior	
LATERALS	Lateral – 10½"	18"D — Lateral – 13¼"	30" exterior – 26½" interior	
		24"D — Lateral – 15½"	36" exterior – 32½" interior 42" exterior – 38½" interior	

Align 24"W Personal Tower

- Wardrobe shelves are 20⁷/₁₆" deep and 1" thick.
- Leveling glides can be extended 1½".

Align 12"W Wardrobe

- Shelves are 16⁷/₁₆" deep on 18"D or 22⁷/₁₆" deep on 24"D and ¾" thick.
- Shelves can adjust at ½" increments in upper and lower section of cabinet.
- Leveling glides can be extended 1".

Interior Shelf Opening Dimensions:

	Width	Depth	Height	No. of Adj. Shelves	Shelf Locations
YPTB □ 4224 (Wardrobe)	7½"	23"	35⅝"	optional	2
YPTB □ 5024 (Wardrobe)	7½"	23"	43⅝"	optional	2
YPTB □ 5724 (Wardrobe)	7½"	23"	50⅝"	optional	2
YPTB □ 524 (Wardrobe)	7½"	23"	58⅝"	optional	2
YPTSB □ 4224 (Wardrobe)	7½"	23"	35⅝"	optional	2
YPTSB □ 5024 (Wardrobe)	7½"	23"	43⅝"	optional	2
YPTSB □ 5724 (Wardrobe)	7½"	23"	50⅝"	optional	2
YPTSB □ 6524 (Wardrobe)	7½"	23"	58⅝"	optional	2
YPTB □ 4224 (Cabinet)	13⅝"	23"	12½"	0	7
YPTB □ 5024 (Cabinet)	13⅝"	23"	20"	1	7
YPTB □ 5724 (Cabinet)	13⅝"	23"	27½"	1	7
YPTB □ 6524 (Cabinet)	13⅝"	23"	35"	1	12
YPTSB □ 4224 (Side Access)	22½"	13¼"	11"	0	0
YPTSB □ 5024 (Side Access)	22½"	13¼"	18½"	1	4
YPTSB □ 5724 (Side Access)	22½"	13¼"	26"	1	4
YPTSB □ 6524 (Side Access)	22½"	13¼"	33½"	2	4
YPWT □ 4212 (Wardrobe)	10½"	23"	35"	1	2
YPWT □ 5012 (Wardrobe)	10½"	23"	42½"	1	2

Interior Opening Dimensions:

	Width	Depth	Height	No. of Adj. Shelves	Shelf Locations
Single Lockers:	10½"	18"D Units have 17"	42½"H Units have 35"H	1	2
	10½"	24"D Units have 23"	50"H Units have 42½"H	1	2
Double Lockers:	10½"	18"D Units have 17"	57"H Units have 25¼"H	0	0
	10½"	24"D Units have 23"	65"H Units have 29"H	0	0
Quad Lockers:	10½"	18"D Units have 17"	57"H Units have 25¼"H	0	0
	10½"	24"D Units have 23"	65"H Units have 29"H	0	0
Cubby Lockers:	10½"	18"D Units have 17"	All cubbies are 14"H	0	0

LOW STORAGE CREDENZAS — LATERAL FILE WIDTH:

24", 42", or 48"W

30" or 60"W

36" or 72"W

(42", 48", 60", and 72" credenzas are half lateral drawer/half open shelf)

Front-to-Back Filing*

Outside tabs of folders rest on drawer sides.

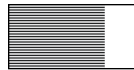
Letter Size Hanging File Folders
(8½ x 11" documents)18"D – 11¼" of letter filing
24"D – 14¾" of letter filing18"D – 23½" of letter filing
24"D – 29½" of letter filing18"D – 23½" of letter filing
24"D – 29½" of letter filingA4 Hanging File Folders
(8¼ x 11⅝" documents)18"D – 11¼" of A4 filing
24"D – 14¾" of A4 filing18"D – 23½" of A4 filing
24"D – 29½" of A4 filing18"D – 23½" of A4 filing
24"D – 29½" of A4 filingLegal Size Hanging File Folders
(8½ x 14" documents)18"D – 11¼" of legal filing
24"D – 14¾" of legal filing18"D – 11¼" of legal filing
24"D – 29½" of legal filing18"D – 23½" of legal filing
24"D – 29½" of legal filing**Side-to-Side Filing**

Letter or A4 Hanging File Folders

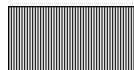
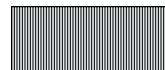
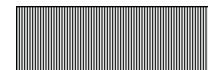
18"D – 20¼" of letter or A4 filing
24"D – 20¼" of letter, A4, or legal filing18"D – 26¼" of letter or A4 filing
24"D – 26¼" of letter, A4, or legal filing18"D – 32¼" of letter or A4 filing
24"D – 32¼" of letter, A4, or legal filing* Front-to-back filing requires optional front-to-back filing bars **YPCAHR12** for 18"D units or **YPCAHR15** for 24"D units, one bar per row of filing. Order bars separately, see page 44.

LATERAL FILE WIDTH

30"W

36"W

42"W

Front-to-Back Filing — outside tabs of folders rest on drawer sides

Letter Size
(8½ x 11")

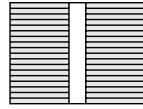

Filing Volume:
29½" (Align™)
30" (Essentials™)

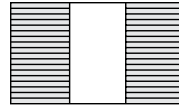

Filing Volume:
29½" (Align)
30" (Essentials)

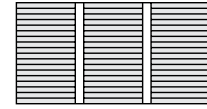

Filing Volume:
44¼" (Align)
45" (Essentials)

SHADED BOX INDICATES
MAXIMUM FILING EFFICIENCY

A4
(8¼ x 11¾")



Filing Volume:
14¾" (Align)
15" (Essentials)

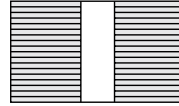

Filing Volume:
29½" (Align)
30" (Essentials)

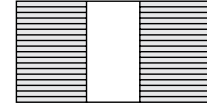

Filing Volume:
29½" (Align)
30" (Essentials)

Legal Size
(8½ x 14")



Filing Volume:
14¾" (Align)
15" (Essentials)

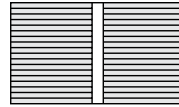

Filing Volume:
29½" (Align)
30" (Essentials)

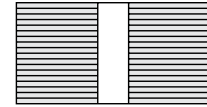

Filing Volume:
29½" (Align)
30" (Essentials)

EDP

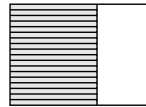

Filing Volume:
14¾" (Align)

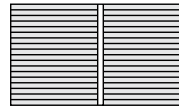

Filing Volume:
29½" (Align)

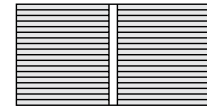

Filing Volume:
29½" (Align)

Side-to-Side Filing

Letter, A4 and Legal

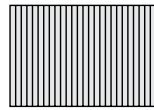

Filing Volume: 26¼"

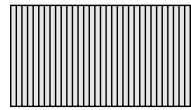

Filing Volume: 32¼"

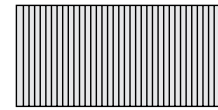

Filing Volume: 38¼"

Load Capacities (per current ANSI/BIFMA standards)

Align™	30" Wide	36" Wide	42" Wide
Opening Height			
12"	87 lbs. (Metal)	107 lbs. (Metal)	126 lbs.

ANSI/BIFMA Standards
Allsteel lateral files, incorporating the **required counterweights** in freestanding situations, meet or exceed the applicable ANSI/BIFMA Storage Unit Test Standards X5.9-2012.

Align Metal Support, Freestanding, and Mobile Pedestals

- Double-wall drawer construction.
- Steel, ball-bearing slide suspension with full-extension drawers.
- Heavy-duty steel O-frame.
- Support pedestals are available with flush or recessed plinth base, Stride feet, or Terrace feet.
- Full front drawers are available as metal or laminate.
- Box drawers have an adjustable divider.
- Standard core removable locks, see page 42.
- For locking specification, see pages 180-182.

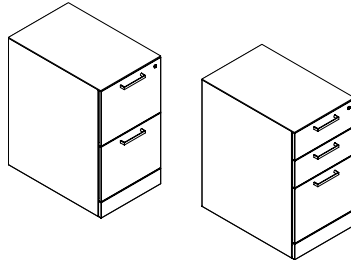
**Align Metal Support Pedestals** (pages 34-37)

- Support pedestals have fully enclosed top.
- Support pedestals not used to support a worksurface require a pedestal top model (ASPT-XXXX) and counterweight kit (2282).
- Available as box/box/file or file/file drawers.
- Pencil trays included — one per pedestal with a box drawer.
- File drawer front reveals of support pedestals will align with Align metal laterals, towers, and credenzas.
- Leveling glides standard on freestanding pedestals.
- Hardware for attaching pedestal to worksurface is included
- 28½"H pedestals can be used to support worksurface at 29½"H.
- Align metal support pedestals are available with flush or recessed base, Stride feet, or Terrace feet.

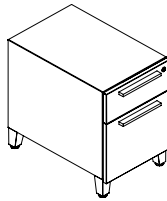
**Align Metal Freestanding Pedestals** (page 36)

- Available as box/file drawers.
- Pencil tray included in box drawer.
- Drawer reveals of freestanding pedestals will align with Align credenzas.
- Leveling glides standard on freestanding pedestals.
- Align metal freestanding pedestals are available with Stride or Terrace feet.

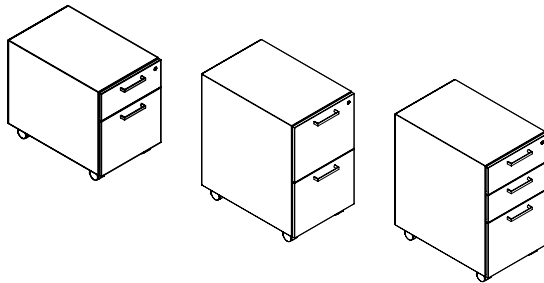
**Align Metal Mobile Pedestals** (pages 34-37)

- Available as box/file, box/box/file or file/file drawers.
- To allow clearance under worksurfaces, an Align mobile pedestal is 1½" shorter than an equivalent Align support pedestal. This, combined with the leveling range of Align support pedestals, personal files, towers, laterals, and credenzas will result in an offset of horizontal drawer reveals of 1½" to 3".
- Counterweight is standard in mobile pedestals.
- Four casters.

Align Metal Support and Mobile Pedestal Tops and Accessories

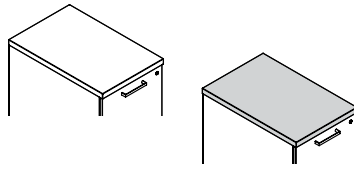

Align Pedestal Tops (page 37)

Field installed tops create additional storage and work areas on metal support or mobile pedestals.

- Particle board construction in laminate.
- Seat cushion provides quick and convenient additional seating on box/file pedestals.
- Seat cushion adds approximately 2"H to pedestal.
- YPPA prefix models have stitched corners and bumpers on bottom.
- Seat cushion to be used on steel (mobile) pedestal top only.
- COM yardage for seat cushion is 0.9 yards.

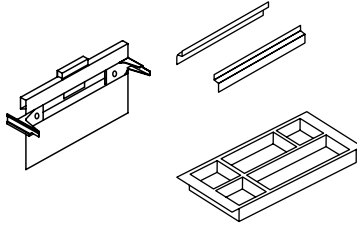

Align Pedestal Accessories (page 37)

- Accessories are for use with Align metal: pedestals, personal files, and personal towers.

Align™ Metal Storage

Credenzas and Accessories

GSA Reference Page

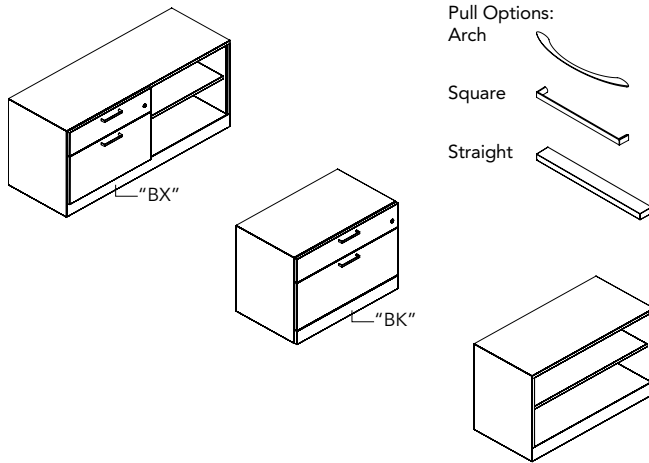

Load Capacities (per current ANSI/BIFMA standards)

Align 22"H Credenzas	24" Wide	30" Wide	36" Wide
3 7/8"H Box Drawer	19 lbs.	24 lbs.	30 lbs.
10 1/2"H Box Drawer	50 lbs.	64 lbs.	78 lbs.

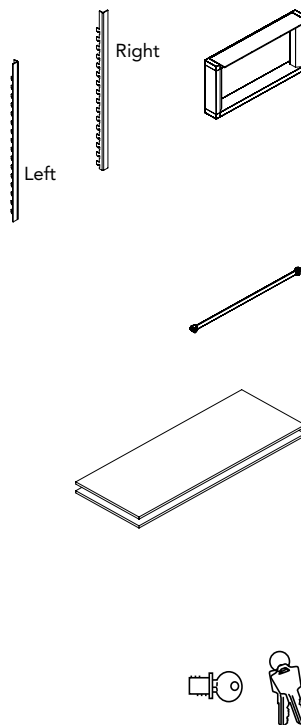

Credenzas (pages 38-43)

- Full metal construction with finished top and back.
- Welded case with "O" frame construction for added strength.
- Full front design with proud, double wall drawer fronts.
- Units are 18"D or 24"D, 17 1/4"D or 23 3/4"D on open bookcases.
- Interlock and full extension ball bearing slides on all drawers.
- Enclosed bottom pan on open bookcase and on box/lateral/open units.
- Available with Stride feet; Terrace feet; or plinth base, either flush or recessed.
- Drawer fronts are available as metal or laminate.
- PR6 Silver pull options: Arch, Square, Straight. Beveled and Integral pull options also available on metal front drawers.
- Plinth base option on drawer only units: recessed or flush.
- Leveling glides can be extended 1 1/2".
- Side-to-side filing bar included. Front-to-back filing with optional filing bar. Two rows of front to back letter filing on drawers 30"W or wider drawers, order 2 filing bars. See page 20.
- Accessories include: seat cushions, laminate tops.
- Planning: requires panel bracket, worksurface stanchion, or counterweight (sold separately) for units with drawers. See page 30 for specification examples.

Storage-to-Panel Bracket (page 42)

- Used to attach the back or side of storage to a panel frame to provide stability when used with Stride, Terrace, or Optimize panel frames.
- Handedness is determined by side of storage that attaches to panel when facing panel run.

Worksurface Support Stanchions (page 42)

- Worksurface stanchions are PR6 Silver and made of aluminum.
- Use 5"H stanchions for 22"H Align credenza with worksurface, or 6"H stanchions for credenza without a worksurface.
- Available in depths of 12" and 18". 12" is designed to work with 18"D worksurfaces and 18" with 24"D worksurfaces. Use two stanchions when mounting a 30"D or deeper worksurface.
- Stanchion orientation should run perpendicular to the length of the worksurface it is supporting.

Front-to-Back Filing Bar (page 42)

- Front-to-back filing bar can be positioned to accommodate letter, A4, or legal size documents. 30"W and wider drawers can accommodate two rows requiring two bars. See page 20.

Counterweight Kits (page 42)

- Metal weight attached to back of freestanding files to inhibit tipping; field installed only. Use of storage-to-panel bracket or worksurface support stanchion may eliminate need for counterweight kit — see examples on page 26.
- Counterweight kit required for freestanding files:

42"W and 48"W Credenzas.....	25 LB kit
24"W, 60"W, and 72"W Credenzas.....	35 LB kit
30"W and 36"W Credenzas.....	50 LB kit

Matte Silver Removable Lock Core Kit (page 42)

- Matte Silver used on Align credenzas with drawers. Includes one core, two keys, one core removal tool, adapter and instructions.
- The Allsteel Easy Lock Program simplifies the lock-core ordering process when multiple cores are being specified. To ensure ease of ordering in different situations the Easy Lock cores can be specified in three different ways — Random, Specified or Sequential. See page 182 for complete details and examples on the Allsteel Easy Lock program.

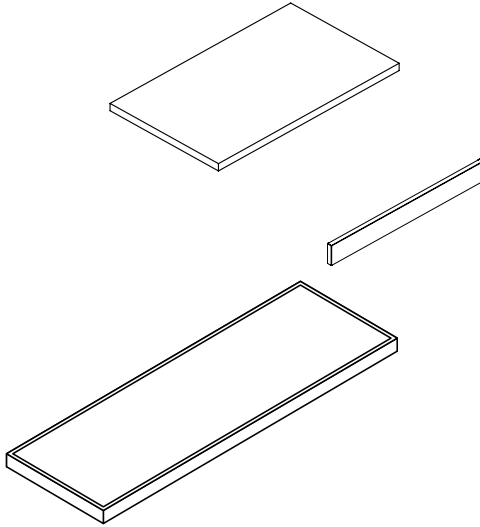

Credenza Cushions (page 43)

- Cushions are for use on 22"H Align credenzas to create additional seating.
- Cushions can be placed directly on metal top of unit or on laminate top.
- Freestanding applications require counterweights — see page 24.

Base Kick Plates for Align Credenzas (page 43)

- Allows field conversion of recessed plinth base unit to be flush with drawer front.

Laminate Tops for Align Credenzas (page 45)

- Tops are 1¼" thick and are field installed. For use in freestanding or layered applications.
- When 54", 60", 66", 72" and 84" tops span two credenzas, add "S2" suffix to add ½" to nominal width of top for freestanding or layered applications.
- For use on 18" and 24" deep Align credenzas. 36"D tops are available for 18"D credenzas placed back-to-back.

Align™ Metal Storage

Metal Credenzas with Panel Frames

GSA Reference Page

Plinth Base models available.

Side-mounted Credenzas

Use 1 storage-to-panel bracket per Credenza — 1 LH and 1 RH.

The minimum credenza size is 22"H x 36"W x 18"D or 24"D.

With a mid-run floor support, the maximum panel run is 144".

Without a mid-run floor support, the maximum panel run is 96".

Overheads and shelves cannot be used with 22"H side mounted credenzas.

Worksurfaces (if specified) must be mounted on the same side of the parent run as the credenzas.

Panel frame maximum height is 65".

Counterweight is required.

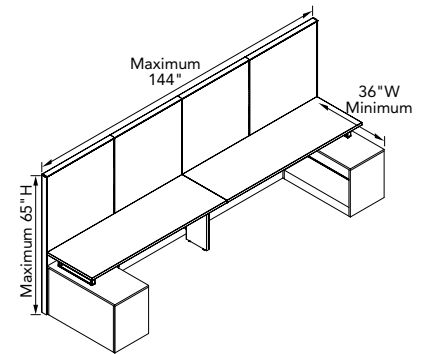

Back-mounted Credenzas — Modular

Use 2 storage-to-panel brackets per Credenza — 2 LH and 2 RH.

The minimum Credenza size is 22"H x 42"W x 18"D or 24"D.

The maximum panel run between back-mounted Credenzas is 60".

Overheads and shelves cannot be used with 22"H back mounted Credenzas.

Worksurfaces (if specified) must be mounted on the same side of the parent run as the Credenzas.

Panel frame maximum height is 65".

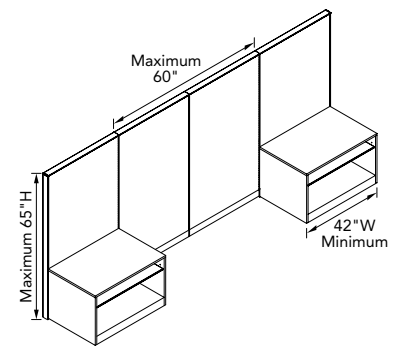

Back-mounted Credenzas — Off-Modular Ends

Use 1 storage-to-panel bracket per Credenza — 1 LH and 1 RH.

The minimum Credenza size is 22"H x 42"W x 18"D or 24"D.

With a mid-run floor support, the maximum panel run is 144".

Without a mid-run floor support, the maximum panel run is 96".

Overheads and shelves cannot be used with 22"H back mounted Credenzas.

Worksurfaces (if specified) must be mounted on the same side of the parent run as the Credenzas.

Panel frame maximum height is 65".

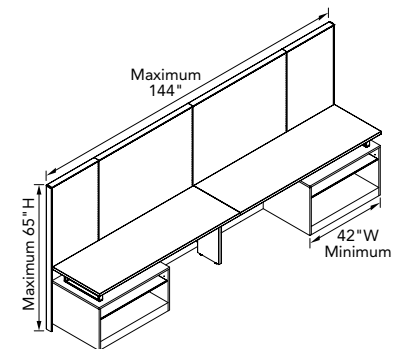

Side-mounted Credenzas — with Return Panel

Use 1 storage-to-panel bracket on Credenza.

The minimum Credenza size is 22"H x 36"W x 18"D or 24"D.

The minimum size for panel return is 35"H x 36"W.

With a mid-run floor support, the maximum panel run is 144".

Without a mid-run floor support, the maximum panel run is 96".

Overheads and shelves cannot be used with 22"H side mounted Credenzas.

Worksurfaces (if specified) must be mounted on the same side of the parent run as the Credenzas.

Panel frame maximum height is 65".

Counterweight is required.

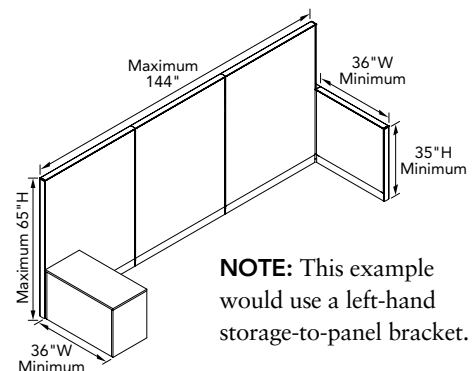

NOTE: This example would use a left-hand storage-to-panel bracket.

Align Lateral Files and Accessories

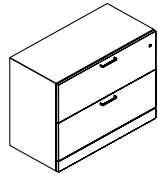

Align Laterals (page 44)

- Square edge full front.
- Five pull options: straight, arch, and square in Silver, and beveled or integral in same color as lateral.
- Square, arch, and straight metal pulls are customer installed.
- All files are 18"D.
- Files ship with glides fully recessed. Extend glides on 2-high files ¼" to align with support pedestals.
- Hanging frames and dividers installed on-site.
- 2-high units have one lock.
- For locking specifications, see pages 180-182.
- Tops are available — order separately.

Note: Counterweight kits are required for freestanding lateral files (i.e., files that are not positioned under a worksurface, ganged to an adjacent file, or bolted to the floor or wall.)

Align Accessories

Counterweight kit(s) (page 44)

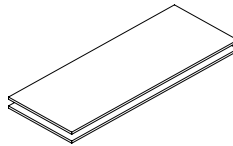

- Counterweight kit(s) required for freestanding files:

2-high 30"W file.....	50 lbs.
2-high 36"W files	57½ lbs.
2-high 42"W files	70 lbs.
- Metal weight placed in bottom of freestanding files to inhibit tipping; field installed only.

Front-to-back Filing Bar (page 44)

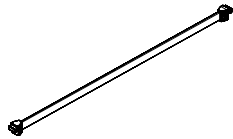

- Front-to-back filing bar can be positioned to accommodate letter, A4, legal or EDP size documents. See page 25 for complete filing information. Front-to-back filing bar must be used with side-to-side hanging frame.
- For 12"H interiors.

Align Tops for Metal Storage

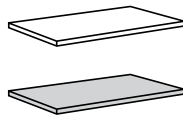

Metal Storage Laminate and Veneer Tops (page 45)

- Tops are field installed.
- 60", 66" and 72" tops span two lateral files. Add "S2" suffix to add ½" to nominal width of top for freestanding applications.
- 18"D tops are for 18"D lateral files and credenzas. 24"D tops are for 24"D credenzas. 36"D tops are available for 18"D storage placed back-to-back.
- Veneer lateral file tops by Gunlocke®.
- Tops are 1¼" thick.
- Stratawood veneer has a consistent straight-grain pattern. Natural veneer will have cathedrals with variations in grain pattern and tone.
- Recommended to complement any veneer or laminate flat edge worksurfaces.

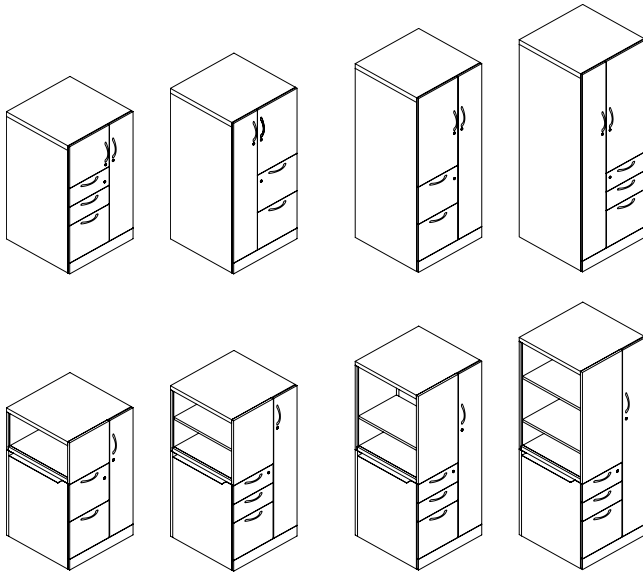
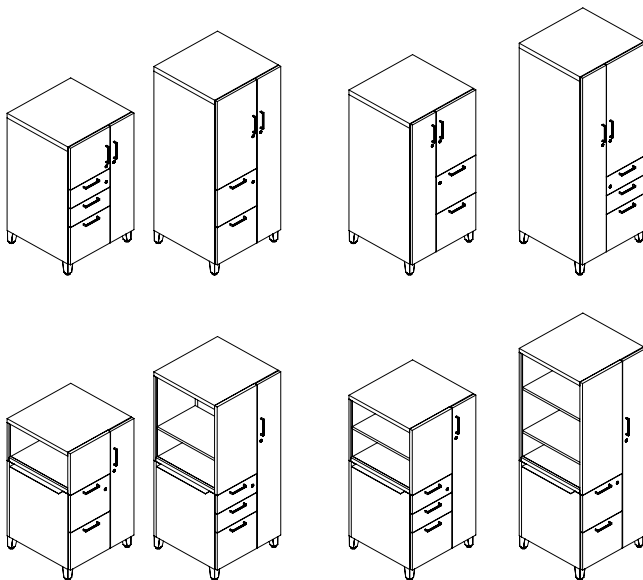
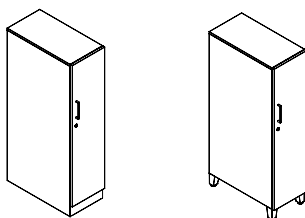
Plinth Base – Flush or Recessed**Foot Base – Stride® or Terrace DNA®****Plinth or Foot Base — 12"W Wardrobe / Locker****Align Metal Personal Towers (pages 44-49)**

- Available with Stride feet; Terrace feet; or plinth base, either flush or recessed.
- Full front drawers and doors are available as metal or laminate.
- Wardrobe is 9"W.
- Cabinet door on 50"H, 57½"H, and 65"H units includes one adjustable shelf.
- Coat rod included in wardrobe portion of 50"H, 57½"H, and 65"H units for best aesthetics.
- Three locks secure drawers and door(s) on front access towers; two locks on side access towers. Standard core removable locks, see page 44.
- Units can be shipped with lock cores removed; cores can then be installed after storage units are placed. Towers can be keyed alike with pedestals, credenzas, laterals, and overhead cabinets.
- Side access models include one worksurface bracket that is compatible with Align, Terrace®, Optimize™, and Concensys®.
- File side-to-side with hanging frames included.
- Heavy-duty, telescoping ball-bearing slides.
- Case has a finished appearance with smooth seams and no overlaps.
- Double bottoms are welded into all files for added rigidity.
- Leveling glides can be adjusted 2¾" from outside or inside the case. Hex-head design of the stem allows leveling to be done even when the cabinet is fully loaded.
- Drawer fronts are fully lined to reduce noise and to prevent damage from drawer contents.
- Drawer alignment matches other Align storage.
- In back-to-back applications with panels, it is recommended to place a panel between units for best aesthetics.

Align 12"W Metal Wardrobe / Locker (page 48)

- Available in 42½" and 50"H, plinth base or footed.
- 24"D models include coat rod and 18"D models a coat hook.
- Includes one adjustable shelf, additional shelves available as field installable model. Shelves can adjust at ½" increments in upper and lower section of the cabinet.
- Unit must be attached to a panel or worksurface. Use worksurface brackets YPWTAWSBKT18 or YPWTAWSBKT24, or panel mounting brackets AP22PBK1H or AP22BKRH.
- Field installable kickplate available to convert a recessed base to flush.
- Plinth base leveling glides provide 1½" of height adjustment; Terrace and Stride feet provide 2" of height adjustment.
- Lock secures door. Standard core removable lock, see page 42.
- Units can be shipped with lock cores removed; cores can then be installed after storage units are placed. Wardrobe can be keyed alike with pedestals, credenzas, laterals, and overhead cabinets.

SINGLE LOCKERS

Plinth Base – Flush or Recessed

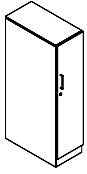

Foot Base – Stride® or Terrace®

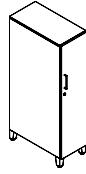

Align lockers provide a comprehensive solution of secure storage outside the primary workstation. Whether you're minimizing the overall workstation footprint or have mobile workers needing a place for their personal belongings, lockers provide the right amount of storage.

Align lockers include single, double, and quad locker variations, as well as an additional cubby solution. Designers have the freedom to select from a variety of aesthetic options including plinth or footed based, painted and laminate fronts, and a variety of pull options, to reflect any company culture.

DOUBLE LOCKERS

Plinth Base – Flush or Recessed

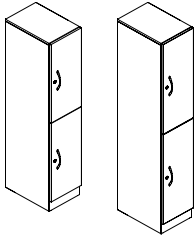

Foot Base – Stride® or Terrace®

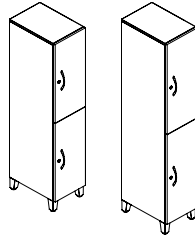

All Align Lockers (pages 50-58)

- Available in plinth base or footed with metal or laminate fronts.
- Field installable kickplate available to convert a recessed base to flush.
- Plinth base leveling glides provide 1½" of height adjustment; Terrace and Stride feet provide 2" of height adjustment.
- Lock secures door. Standard core removable lock, see page 42.
- Units can be shipped with lock cores removed; cores can then be installed after storage units are placed. Wardrobe can be keyed alike with pedestals, credenzas, laterals, and overhead cabinets.
- Installation instructions for lockers is available on the Allsteel Synergy website on the Align product page.
- Lockers are not meant to be wall mounted. Refer to installation instructions for ganging and mounting options.
- See page 23 for interior dimensions.

QUAD LOCKERS

Plinth Base – Flush or Recessed

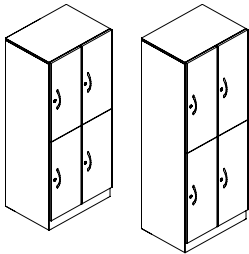

Foot Base – Stride® or Terrace®

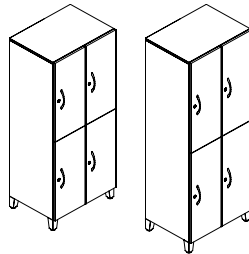

Align 12"W Single Lockers (pages 50-51)

- Available in 42½" or 50"H and 18" or 24"D.
- 24"D models include coat rod and 18"D models two double coat hooks.
- Includes one adjustable shelf, additional shelves available as field installable model. Shelves can adjust at ½" increments in upper and lower section of the cabinet.
- Single lockers must be attached to a panel or worksurface. Use worksurface brackets YPWTAWSBKT18 or YPWTAWSBKT24, panel mounting brackets AP22PBKLN or AP22BKRH, or gang two or more units with common worksurface using double face tape.

CUBBY LOCKERS

Plinth Base – Flush or Recessed

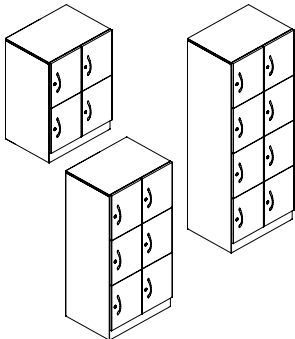

Foot Base – Stride® or Terrace®

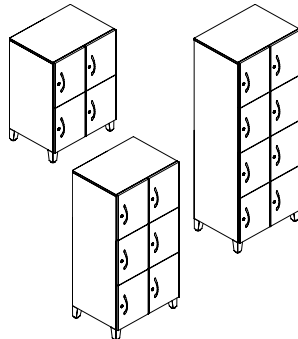

Align 12"W Double Lockers (pages 52-53)

- Available in 57" or 65"H and 18" or 24"D.
- Models include two coat hooks in each compartment.
- Unit must be attached to a panel or worksurface. Use worksurface brackets YPWTAWSBKT18 or YPWTAWSBKT24, panel mounting brackets AP22PBKLN or AP22BKRH, or gang two or more units with common worksurface using double face tape.

Align 24"W Quad Lockers (pages 54-55)

- Available in 57" or 65"H and 18" or 24"D.
- All models include two double coat hooks in each compartment.

Align 24"W Cubby Lockers (pages 56-57)

- 18" depth and 35", 50", or 65"H.
- All models include two double coat hooks in each compartment.

Laminate Tops for Lockers (page 58)

- Tops are ¼" thick and are field installed. For use in freestanding or ganging applications.
- When tops span two or more lockers, add ½" to nominal width of top for each additional unit. See examples on page 58.
- For use on 18" and 24" deep Align lockers. 36"D tops are available for 18"D lockers placed back-to-back.

Align™ Metal Storage

Support and Mobile Pedestals

For specification information see pages 18 and 26-27.

Metal Fronts with Plinth Base

GSA SIN 711-1

Description	New Model — Add “X” or “K” “BX” Recessed Base “BK” Flush Kickplate	Core Paint		Select Paint
		P1 List Price	P2 List Price	P2 List Price
Support Pedestal 28½"H — File/File — Metal Case/Metal Fronts				
18"D x 15"W*	YPPSB □ 281518FFM	\$ 736	\$ 796	\$ 796
23¼"D x 15"W	YPPSB □ 281524FFM	\$ 767	\$ 827	\$ 827
29¼"D x 15"W	YPPSB □ 281530FFM	\$ 791	\$ 851	\$ 851
Support Pedestal 28½"H — Box/Box/File — Metal Case/Metal Fronts				
18"D x 15"W*	YPPSB □ 281518BBFM	\$ 736	\$ 796	\$ 796
23¼"D x 15"W	YPPSB □ 281524BBFM	\$ 767	\$ 827	\$ 827
29¼"D x 15"W	YPPSB □ 281530BBFM	\$ 791	\$ 851	\$ 851
Mobile Pedestal 26½"H — File/File — Metal Case/Metal Fronts				
18"D x 15"W*	YPPM271518FFM	\$ 745	\$ 805	\$ 805
23¼"D x 15"W	YPPM271524FFM	\$ 776	\$ 836	\$ 836
29¼"D x 15"W	YPPM271530FFM	\$ 800	\$ 860	\$ 860
Mobile Pedestal 26½"H — Box/Box/File — Metal Case/Metal Fronts				
18"D x 15"W*	YPPM271518BBFM	\$ 745	\$ 805	\$ 805
23¼"D x 15"W	YPPM271524BBFM	\$ 776	\$ 836	\$ 836
29¼"D x 15"W	YPPM271530BBFM	\$ 800	\$ 860	\$ 860
Mobile Pedestal 20½"H — Box/File — Metal Case/Metal Fronts				
18"D x 15"W*	YPPM211518BFM	\$ 624	\$ 684	\$ 684
23¼"D x 15"W	YPPM211524BFM	\$ 653	\$ 713	\$ 713
29¼"D x 15"W	YPPM211530BFM	\$ 683	\$ 743	\$ 743

Square Pulls shown

*18"D Pedestals do not accommodate legal size filing.

<p>How to specify — Select the Model Number from above.</p> <p>Y P </p> <p> </p>	<p>1st Option: Pull Option (if applicable):</p> <p>A Arch S Square H Straight <i>Pulls are PR6 Silver, color not specified.</i></p> <p>B Beveled I Integral</p> <p> .</p>	<p>2nd Option: Paint:</p> <p>P .</p>	<p>3rd Option: Lock (if applicable):</p> <p>L Lock X Omit Lock Core (Deduct \$18) <i>Lock is EL Matte Silver, color not specified.</i></p> <p> </p>
--	---	---	---

Examples: YPPSBK281524BBFMA.P02.L
YPPM271524FFMS.PQ8.X

Shippable by small-package carrier.

Align™ Metal Storage

For specification information see pages 18 and 26-27.

Support and Freestanding Pedestals

Metal or Laminate Fronts with Stride or Terrace Feet

GSA SIN 711-1

Description	New Model — Add "T" or "Z" "TF" for Terrace Feet, or "ZF" for Stride Feet +\$63 extra	Core Paint		Select Paint	
		P1 List Price	P2 List Price	P1 List Price	P2 List Price
Support Pedestal 28½"H — File/File — Metal Case/Metal Fronts					
18"D x 15"W*	YPPS □ F281518FFM	\$ 869	\$ 929	\$ 869	\$ 929
23¼"D x 15"W	YPPS □ F281524FFM	\$ 899	\$ 959	\$ 899	\$ 959
29¼"D x 15"W	YPPS □ F281530FFM	\$ 923	\$ 983	\$ 923	\$ 983
Support Pedestal 28½"H — Box/Box/File — Metal Case/Metal Fronts					
18"D x 15"W*	YPPS □ F281518BBFM	\$ 869	\$ 929	\$ 869	\$ 929
23¼"D x 15"W	YPPS □ F281524BBFM	\$ 899	\$ 959	\$ 899	\$ 959
29¼"D x 15"W	YPPS □ F281530BBFM	\$ 923	\$ 983	\$ 923	\$ 983
Freestanding Pedestal 22"H — Box/File — Metal Case/Metal Fronts					
18"D x 15"W*	YPPF □ F221518BFM	\$ 843	\$ 903	\$ 843	\$ 903
23¼"D x 15"W	YPPF □ F221524BFM	\$ 874	\$ 934	\$ 874	\$ 934

Width	"TF" for Terrace Feet, or "ZF" for Stride Feet +\$63 extra	Core Paint			Select Paint		
		L1	L2	L3	L1	L2	L3
Support Pedestal 28½"H — File/File — Metal Case/Laminate Fronts							
18"D x 15"W*	YPPS □ F281518FFL	\$ 922	\$ 970	\$ 1013	\$ 982	\$ 1030	\$ 1073
23¼"D x 15"W	YPPS □ F281524FFL	\$ 955	\$ 1015	\$ 1067	\$ 1015	\$ 1075	\$ 1127
29¼"D x 15"W	YPPS □ F281530FFL	\$ 981	\$ 1043	\$ 1096	\$ 1041	\$ 1103	\$ 1156
Support Pedestal 28½"H — Box/Box/File — Metal Case/Laminate Fronts							
18"D x 15"W*	YPPS □ F281518BBFL	\$ 976	\$ 1024	\$ 1067	\$ 1036	\$ 1084	\$ 1127
23¼"D x 15"W	YPPS □ F281524BBFL	\$ 1010	\$ 1071	\$ 1128	\$ 1070	\$ 1131	\$ 1188
29¼"D x 15"W	YPPS □ F281530BBFL	\$ 1038	\$ 1101	\$ 1158	\$ 1098	\$ 1161	\$ 1218
Freestanding Pedestal 22"H — Box/File — Metal Case/Laminate Fronts							
18"D x 15"W*	YPPF □ F221518BFLL	\$ 1085	\$ 1147	\$ 1202	\$ 1145	\$ 1207	\$ 1262
23¼"D x 15"W	YPPF □ F221524BFLL	\$ 1102	\$ 1171	\$ 1241	\$ 1162	\$ 1231	\$ 1301

*18"D Pedestals do not accommodate legal size filing.

NOTE: Laminate front models are limited to Arch, Square, or Straight Pulls.

<p>How to specify — Select the Model Number from above.</p> <p>Y P _____</p> <p>_____</p>	<p>1st Option: Pull Option (if applicable):</p> <p>A Arch S Square H Straight Pulls are PR6 Silver, color not specified.</p> <p>B Beveled I Integral</p>	<p>2nd Option: Paint:</p> <p>☉ ☉</p> <p>See inside front cover for finishes.</p>	<p>3rd Option: Lock:</p> <p>L Lock X Omit Lock Core (Deduct \$18) Lock is EL Matte Silver, color not specified.</p>	<p>4th Option: Laminate (if applicable):</p>	<p>5th Option: Edge (if applicable):</p> <p>Edge color is pre-determined by laminate selection.</p>
--	--	---	--	--	---

Examples: YPPSTF281518FFMS.P02.L YPPSSF281518FFLH.P27.X.LM14EW

For specification information see pages 18 and 26-27.

GSA SIN 711-1

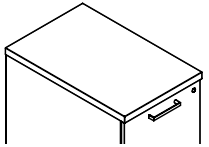

Description	Model	L1 List Price	L2 List Price	L3 List Price
Laminate Top — Flat Edge (for metal pedestal case)				
23½"D	ASPTP-24LL <input type="checkbox"/>	\$ 197	\$ 207	\$ 218
29½"D	ASPTP-30LL <input type="checkbox"/>	\$ 243	\$ 256	\$ 269

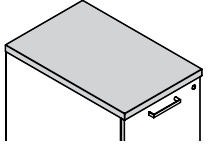

Description	Model	V1 List Price	V3 List Price	V5 List Price
Veneer Top (for metal pedestal case)				
24"D	ASPTP-24LW <input type="checkbox"/>	\$ 602	\$ 656	\$ 731
30"D	ASPTP-30LW <input type="checkbox"/>	\$ 627	\$ 685	\$ 762

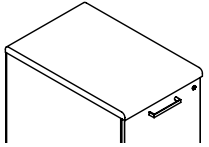

Description	Model	List Price							
		Grade 1	Grade 2	Grade 3	Grade 4	Grade 5	Grade 6	Grade 7	Grade 8
Seat Cushion — For Metal Mobile Pedestals only (specify seating upholstery — no leathers)									
17"D	YPPA1815SC <input type="checkbox"/>	\$ 142	\$ 169	\$ 185	\$ 202	\$ 221	\$ 237	\$ 256	\$ 275
23"D	YPPA2415SC <input type="checkbox"/>	\$ 168	\$ 196	\$ 213	\$ 231	\$ 251	\$ 268	\$ 287	\$ 308
29"D	YPPA3015SC <input type="checkbox"/>	\$ 175	\$ 205	\$ 223	\$ 242	\$ 263	\$ 280	\$ 300	\$ 322

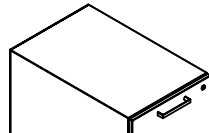

Description	Model	Core Paint P1 List Price	Select Paint P2 List Price
Steel Top (for metal support pedestal case)			
18"D	YPPAST1518 <input type="checkbox"/>	\$ 171	\$ 184
24"D	YPPAST1524 <input type="checkbox"/>	\$ 180	\$ 194
30"D	YPPAST1530 <input type="checkbox"/>	\$ 195	\$ 211

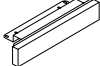

Flush Front Kickplate			
For 15"W Recessed Base Support Pedestal	YPPAK15 <input type="checkbox"/>	\$ 105	\$ 117



Description	Model	List Price
Box Drawer Accessories		
Pencil Tray (Black only)	A2280-000 <input type="checkbox"/>	\$ 29

Counterweights			
For 20½"H Pedestals produced prior to 11/1/2015	2282-300 <input type="checkbox"/>		\$ 147
For 28½"H Pedestals produced prior to 11/1/2015	2282-400 <input type="checkbox"/>		\$ 161

<p>How to specify — Select the Model Number from above.</p>	<p><i>1st Option:</i> Laminate or Veneer Type and Finish (if applicable): See inside front cover for finishes.</p>	<p><i>1st Option:</i> Paint (if applicable): See inside front cover for finishes.</p>	<p><i>2nd Option:</i> Edge (if applicable): Laminate Flat Edge Tops only. See inside front cover for finishes.</p>	<p><i>Only Option for Seat Cushion:</i> Upholstery: Specify seating upholstery.</p>
<p>Examples: ASPTP-24LL.TM20.E2</p>	<p>YPPA2415SC.PNS012</p>	<p>2282-400</p>	<p><input type="checkbox"/> Shippable by small-package carrier.</p>	

Align™ Metal Storage

22"H Credenzas

For specification information see pages 18-24 and 28-30.

Metal Fronts with Plinth Base

GSA SIN 711-1

Description	Model – "BX" Recessed Base or – "BK" Flush Kickplate	Recessed Base "BX"		Flush Base "BK"	
		P1 Core	P2 Select	P1 Core	P2 Select
22"H Box/Lateral and Right Open w/Metal Shelf					
42"W x 18"D	YPCB □ 224218RBFOM	\$ 1941	\$ 2060	\$ 2005	\$ 2124
42"W x 24"D	YPCB □ 224224RBFOM	\$ 2066	\$ 2193	\$ 2135	\$ 2262
48"W x 18"D	YPCB □ 224818RBFOM (shown)	\$ 2005	\$ 2124	\$ 2071	\$ 2190
48"W x 24"D	YPCB □ 224824RBFOM	\$ 2135	\$ 2262	\$ 2205	\$ 2332
60"W x 18"D	YPCB □ 226018RBFOM	\$ 2124	\$ 2243	\$ 2189	\$ 2308
60"W x 24"D	YPCB □ 226024RBFOM	\$ 2262	\$ 2389	\$ 2331	\$ 2458
72"W x 18"D	YPCB □ 227218RBFOM	\$ 2319	\$ 2438	\$ 2385	\$ 2504
72"W x 24"D	YPCB □ 227224RBFOM	\$ 2469	\$ 2596	\$ 2539	\$ 2666

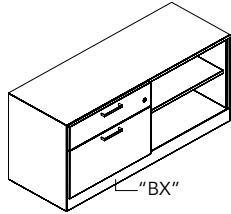

22"H Left Open w/Metal Shelf and Box/Lateral					
42"W x 18"D	YPCB □ 224218LBFOM	\$ 1941	\$ 2060	\$ 2005	\$ 2124
42"W x 24"D	YPCB □ 224224LBFOM	\$ 2066	\$ 2193	\$ 2135	\$ 2262
48"W x 18"D	YPCB □ 224818LBFOM (shown)	\$ 2005	\$ 2124	\$ 2071	\$ 2190
48"W x 24"D	YPCB □ 224824LBFOM	\$ 2135	\$ 2262	\$ 2205	\$ 2332
60"W x 18"D	YPCB □ 226018LBFOM	\$ 2124	\$ 2243	\$ 2189	\$ 2308
60"W x 24"D	YPCB □ 226024LBFOM	\$ 2262	\$ 2389	\$ 2331	\$ 2458
72"W x 18"D	YPCB □ 227218LBFOM	\$ 2319	\$ 2438	\$ 2385	\$ 2504
72"W x 24"D	YPCB □ 227224LBFOM	\$ 2469	\$ 2596	\$ 2539	\$ 2666

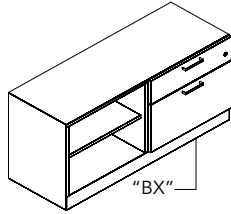

22"H Box/Lateral					
24"W x 18"D	YPCB □ 222418BFM	\$ 1274	\$ 1354	\$ 1339	\$ 1419
24"W x 24"D	YPCB □ 222424BFM	\$ 1356	\$ 1443	\$ 1425	\$ 1512
30"W x 18"D	YPCB □ 223018BFM (shown)	\$ 1300	\$ 1380	\$ 1365	\$ 1445
30"W x 24"D	YPCB □ 223024BFM	\$ 1384	\$ 1471	\$ 1454	\$ 1541
36"W x 18"D	YPCB □ 223618BFM	\$ 1448	\$ 1528	\$ 1512	\$ 1592
36"W x 24"D	YPCB □ 223624BFM	\$ 1541	\$ 1628	\$ 1610	\$ 1697
42"W x 18"D	YPCB □ 224218BFM	\$ 1593	\$ 1673	\$ 1658	\$ 1738
42"W x 24"D	YPCB □ 224224BFM	\$ 1696	\$ 1783	\$ 1765	\$ 1852

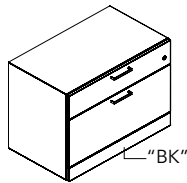

22"H Open Binder w/Metal Shelf					
24"W x 17¼"D	YPCB □ 222418O	\$ 905	\$ 985	\$ 1041	\$ 1121
24"W x 23¼"D	YPCB □ 222424O	\$ 964	\$ 1051	\$ 1108	\$ 1195
30"W x 17¼"D	YPCB □ 223018O	\$ 921	\$ 1001	\$ 1056	\$ 1136
30"W x 23¼"D	YPCB □ 223024O	\$ 980	\$ 1067	\$ 1124	\$ 1211
36"W x 17¼"D	YPCB □ 223618O (shown)	\$ 1003	\$ 1083	\$ 1138	\$ 1218
36"W x 23¼"D	YPCB □ 223624O	\$ 1068	\$ 1155	\$ 1212	\$ 1299
42"W x 17¼"D	YPCB □ 224218O	\$ 1111	\$ 1191	\$ 1246	\$ 1326
42"W x 23¼"D	YPCB □ 224224O	\$ 1183	\$ 1270	\$ 1326	\$ 1413

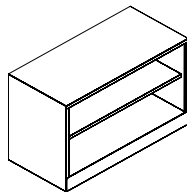

How to specify — Select the Model Number from above.	1st Option: Pulls Option (if applicable): H Straight A Arch S Square <i>Pulls are PR6 Silver, color not specified.</i> B Beveled I Integral	2nd Option: Paint Case: Ⓞ Ⓢ See inside front cover for finishes.	3rd Option: Paint Shelf (if applicable): Ⓢ Ⓞ Ⓜ Specify "NA" for shelf color to match case color; or specify a different Core, Select, or Accent paint and add \$73.	4th Option: Lock (if applicable): L Lock X Omit Lock Core (deduct \$18)
Y P C B				

Examples: YPCBX224218RBFOMH.P7B.NA.L
YPCBX224218O.P27.P7G.X

Align™ Metal Storage

22"H Credenzas

For specification information see pages 18-24 and 28-30.

Laminate Fronts with Plinth Base

GSA SIN 711-1

Width	Model	P1 Core Paint			P2 Select Paint		
		L1	L2	L3	L1	L2	L3
22"H Box/Lateral w/Laminate Fronts and Right Open w/Metal Shelf							
42"W x 18"D	YPCBX224218RBFOL	\$ 2124	\$ 2229	\$ 2335	\$ 2243	\$ 2348	\$ 2454
42"W x 24"D	YPCBX224224RBFOL	\$ 2262	\$ 2374	\$ 2487	\$ 2381	\$ 2493	\$ 2606
48"W x 18"D	YPCBX224818RBFOL (shown)	\$ 2189	\$ 2297	\$ 2407	\$ 2308	\$ 2416	\$ 2526
48"W x 24"D	YPCBX224824RBFOL	\$ 2331	\$ 2448	\$ 2565	\$ 2450	\$ 2567	\$ 2684
60"W x 18"D	YPCBX226018RBFOL	\$ 2330	\$ 2447	\$ 2562	\$ 2449	\$ 2566	\$ 2681
60"W x 24"D	YPCBX226024RBFOL	\$ 2481	\$ 2606	\$ 2729	\$ 2600	\$ 2725	\$ 2848
72"W x 18"D	YPCBX227218RBFOL	\$ 2570	\$ 2698	\$ 2826	\$ 2689	\$ 2817	\$ 2945
72"W x 24"D	YPCBX227224RBFOL	\$ 2736	\$ 2872	\$ 3009	\$ 2855	\$ 2991	\$ 3128

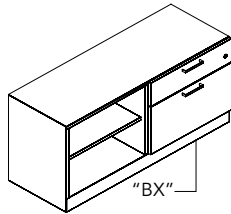
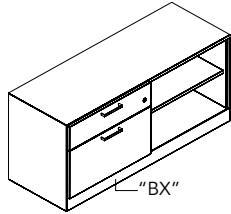

22"H Left Open w/Metal Shelf and Box/Lateral w/Laminate Fronts

42"W x 18"D	YPCBX224218LBFOL	\$ 2124	\$ 2229	\$ 2335	\$ 2243	\$ 2348	\$ 2454
42"W x 24"D	YPCBX224224LBFOL	\$ 2262	\$ 2374	\$ 2487	\$ 2381	\$ 2493	\$ 2606
48"W x 18"D	YPCBX224818LBFOL (shown)	\$ 2189	\$ 2297	\$ 2407	\$ 2308	\$ 2416	\$ 2526
48"W x 24"D	YPCBX224824LBFOL	\$ 2331	\$ 2448	\$ 2565	\$ 2450	\$ 2567	\$ 2684
60"W x 18"D	YPCBX226018LBFOL	\$ 2330	\$ 2447	\$ 2562	\$ 2449	\$ 2566	\$ 2681
60"W x 24"D	YPCBX226024LBFOL	\$ 2481	\$ 2606	\$ 2729	\$ 2600	\$ 2725	\$ 2848
72"W x 18"D	YPCBX227218LBFOL	\$ 2570	\$ 2698	\$ 2826	\$ 2689	\$ 2817	\$ 2945
72"W x 24"D	YPCBX227224LBFOL	\$ 2736	\$ 2872	\$ 3009	\$ 2855	\$ 2991	\$ 3128

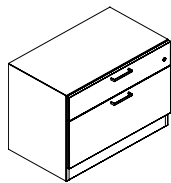

22"H Box/Lateral w/Laminate Fronts

24"W x 18"D	YPCBX222418BFL	\$ 1458	\$ 1530	\$ 1603	\$ 1538	\$ 1610	\$ 1683
24"W x 24"D	YPCBX222424BFL	\$ 1552	\$ 1629	\$ 1707	\$ 1632	\$ 1709	\$ 1787
30"W x 18"D	YPCBX223018BFL (shown)	\$ 1507	\$ 1581	\$ 1657	\$ 1587	\$ 1661	\$ 1737
30"W x 24"D	YPCBX223024BFL	\$ 1605	\$ 1685	\$ 1765	\$ 1685	\$ 1765	\$ 1845
36"W x 18"D	YPCBX223618BFL	\$ 1696	\$ 1781	\$ 1865	\$ 1776	\$ 1861	\$ 1945
36"W x 24"D	YPCBX223624BFL	\$ 1806	\$ 1897	\$ 1987	\$ 1886	\$ 1977	\$ 2067
42"W x 18"D	YPCBX224218BF	\$ 1864	\$ 1957	\$ 2050	\$ 1944	\$ 2037	\$ 2130
42"W x 24"D	YPCBX224224BFL	\$ 1984	\$ 2083	\$ 2183	\$ 2064	\$ 2163	\$ 2263

How to specify — Select the Model Number from above.	1st Option: Pull Option:	2nd Option: Paint:	3rd Option: Paint Shelf (if applicable):	4th Option: Lock:	5th Option: Laminate:	6th Option: Edge:
Y P	A Arch S Square H Straight <i>Pulls are PR6 Silver, color not specified.</i>	CS See inside front cover for finishes.	CSA Specify "NA" for shelf color to match case color; or specify a different Core, Select, or Accent paint and add \$73.	L Lock X Omit Lock Core (Deduct \$18) <i>Lock is EL Silver, color not specified.</i>		Edge color is pre-determined by laminate selection.
	.	P	P	.		

Examples: YPCBX224218RBFOLA.P02.P7E.L.LM14EW YPCBX222418BFLS.P28.P7H.X.LM16E9

Align™ Metal Storage

22"H Credenzas

For specification information see pages 18-24 and 28-30.

Metal Fronts with Stride or Terrace Feet

GSA SIN 711-1

Description	Create Model — Add "T" or "Z": "TF" Terrace Feet, or "ZF" Stride Feet +\$63 extra	Core	Select
		Paint	Paint
		P1 List Price	P2 List Price
22"H Box/Lateral and Right Open w/Metal Shelf			
42"W x 18"D	YPC □ F224218RBFOM	\$ 2076	\$ 2195
42"W x 24"D	YPC □ F224224RBFOM	\$ 2211	\$ 2338
48"W x 18"D	YPC □ F224818RBFOM (shown)	\$ 2141	\$ 2260
48"W x 24"D	YPC □ F224824RBFOM	\$ 2279	\$ 2406
60"W x 18"D	YPC □ F226018RBFOM	\$ 2293	\$ 2412
60"W x 24"D	YPC □ F226024RBFOM	\$ 2442	\$ 2569
72"W x 18"D	YPC □ F227218RBFOM	\$ 2488	\$ 2607
72"W x 24"D	YPC □ F227224RBFOM	\$ 2649	\$ 2776

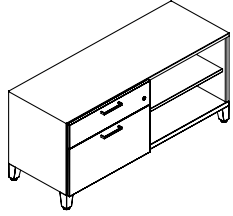

22"H Left Open w/Metal Shelf and Box/Lateral

42"W x 18"D	YPC □ F224218LBFOM	\$ 2076	\$ 2195
42"W x 24"D	YPC □ F224224LBFOM	\$ 2211	\$ 2338
48"W x 18"D	YPC □ F224818LBFOM (shown)	\$ 2141	\$ 2260
48"W x 24"D	YPC □ F224824LBFOM	\$ 2279	\$ 2406
60"W x 18"D	YPC □ F226018LBFOM	\$ 2293	\$ 2412
60"W x 24"D	YPC □ F226024LBFOM	\$ 2442	\$ 2569
72"W x 18"D	YPC □ F227218LBFOM	\$ 2488	\$ 2607
72"W x 24"D	YPC □ F227224LBFOM	\$ 2649	\$ 2776

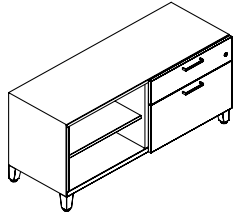

22"H Box/Lateral

24"W x 18"D	YPC □ F222418BFM	\$ 1410	\$ 1490
24"W x 24"D	YPC □ F222424BFM	\$ 1501	\$ 1588
30"W x 18"D	YPC □ F223018BFM (shown)	\$ 1436	\$ 1516
30"W x 24"D	YPC □ F223024BFM	\$ 1529	\$ 1616
36"W x 18"D	YPC □ F223618BFM	\$ 1582	\$ 1662
36"W x 24"D	YPC □ F223624BFM	\$ 1685	\$ 1772
42"W x 18"D	YPC □ F224218BFM	\$ 1729	\$ 1809
42"W x 24"D	YPC □ F224224BFM	\$ 1841	\$ 1928

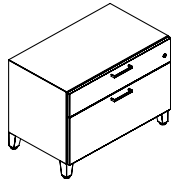

22"H Open Binder w/Metal Shelf

24"W x 17¼"D	YPC □ F222418O	\$ 1041	\$ 1121
24"W x 23¼"D	YPC □ F222424O	\$ 1108	\$ 1195
30"W x 17¼"D	YPC □ F223018O (shown)	\$ 1056	\$ 1136
30"W x 23¼"D	YPC □ F223024O	\$ 1124	\$ 1211
36"W x 17¼"D	YPC □ F223618O	\$ 1138	\$ 1218
36"W x 23¼"D	YPC □ F223624O	\$ 1212	\$ 1299
42"W x 17¼"D	YPC □ F224218O	\$ 1246	\$ 1326
42"W x 23¼"D	YPC □ F224224O	\$ 1326	\$ 1413

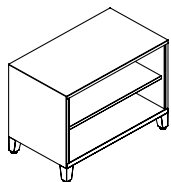

<p>How to specify —</p> <p>Select the Model Number from above.</p> <p>Y P </p> <p> </p>	<p>1st Option:</p> <p>Pull Option (if applicable):</p> <p>A Arch S Square H Straight Pulls are PR6 Silver, color not specified.</p> <p>B Beveled I Integral</p> <p> .</p>	<p>2nd Option:</p> <p>Paint:</p> <p>☉ ☑</p> <p>See inside front cover for finishes.</p> <p>P .</p>	<p>3rd Option:</p> <p>Paint Shelf (if applicable):</p> <p>☉ ☑ ☑</p> <p>Specify "NA" for shelf color to match case color; or specify a different Core, Select, or Accent paint and add \$73.</p> <p>P .</p>	<p>4th Option:</p> <p>Lock (if applicable):</p> <p>L Lock X Omit Lock Core (Deduct \$18) Lock is EL Silver, color not specified.</p> <p> .</p>	<p>5th Option:</p> <p>Foot Paint Color:</p> <p>☉ ☑</p> <p>See inside front cover for finishes. Stride feet are limited to PR6 Silver.</p> <p>P </p>
---	--	--	--	---	--

Examples: YPCTF224218RBFOLS.P02.P7E.L.P02
YPCZF222418O.P28.P7H.PR6

Align™ Metal Storage

22"H Credenzas

For specification information see pages 18-24 and 28-30.

Laminate Fronts with Stride or Terrace Feet

GSA SIN 711-1

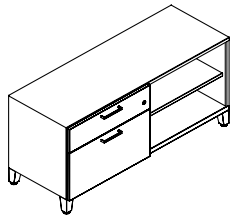

Width	Create Model — Add "T" or "Z": "TF" Terrace Feet, or "ZF" Stride Feet +\$63 extra	P1 Core Paint			P2 Select Paint		
		L1	L2	L3	L1	L2	L3
22"H Box/Lateral w/Laminate Fronts and Right Open w/Metal Shelf							
42"W x 18"D	YPC □ F224218RBFOL	\$ 2260	\$ 2372	\$ 2485	\$ 2340	\$ 2452	\$ 2565
42"W x 24"D	YPC □ F224224RBFOL	\$ 2407	\$ 2527	\$ 2648	\$ 2487	\$ 2607	\$ 2728
48"W x 18"D	YPC □ F224818RBFOL (shown)	\$ 2325	\$ 2442	\$ 2557	\$ 2405	\$ 2502	\$ 2637
48"W x 24"D	YPC □ F224824RBFOL	\$ 2476	\$ 2601	\$ 2723	\$ 2556	\$ 2681	\$ 2803
60"W x 18"D	YPC □ F226018RBFOL	\$ 2498	\$ 2623	\$ 2748	\$ 2578	\$ 2703	\$ 2828
60"W x 24"D	YPC □ F226024RBFOL	\$ 2660	\$ 2794	\$ 2927	\$ 2740	\$ 2874	\$ 3007
72"W x 18"D	YPC □ F227218RBFOL	\$ 2737	\$ 2873	\$ 3010	\$ 2817	\$ 2953	\$ 3090
72"W x 24"D	YPC □ F227224RBFOL	\$ 2915	\$ 3061	\$ 3206	\$ 2995	\$ 3141	\$ 3286

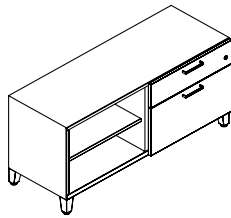

22"H Left Open w/Metal Shelf and Box/Lateral w/Laminate Fronts							
42"W x 18"D	YPC □ F224218LBFOL	\$ 2260	\$ 2372	\$ 2485	\$ 2340	\$ 2452	\$ 2565
42"W x 24"D	YPC □ F224224LBFOL	\$ 2407	\$ 2527	\$ 2648	\$ 2487	\$ 2607	\$ 2728
48"W x 18"D	YPC □ F224818LBFOL (shown)	\$ 2325	\$ 2442	\$ 2557	\$ 2405	\$ 2502	\$ 2637
48"W x 24"D	YPC □ F224824LBFOL	\$ 2476	\$ 2601	\$ 2723	\$ 2556	\$ 2681	\$ 2803
60"W x 18"D	YPC □ F226018LBFOL	\$ 2498	\$ 2623	\$ 2748	\$ 2578	\$ 2703	\$ 2828
60"W x 24"D	YPC □ F226024LBFOL	\$ 2660	\$ 2794	\$ 2927	\$ 2740	\$ 2874	\$ 3007
72"W x 18"D	YPC □ F227218LBFOL	\$ 2737	\$ 2873	\$ 3010	\$ 2817	\$ 2953	\$ 3090
72"W x 24"D	YPC □ F227224LBFOL	\$ 2915	\$ 3061	\$ 3206	\$ 2995	\$ 3141	\$ 3286

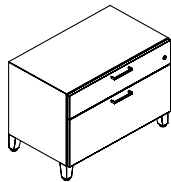

22"H Box/Lateral w/Laminate Fronts							
24"W x 18"D	YPC □ F222418BFL	\$ 1593	\$ 1672	\$ 1752	\$ 1673	\$ 1752	\$ 1862
24"W x 24"D	YPC □ F222424BFL	\$ 1696	\$ 1780	\$ 1865	\$ 1776	\$ 1860	\$ 1945
30"W x 18"D	YPC □ F223018BFL (shown)	\$ 1643	\$ 1724	\$ 1807	\$ 1723	\$ 1804	\$ 1887
30"W x 24"D	YPC □ F223024BFL	\$ 1750	\$ 1836	\$ 1924	\$ 1830	\$ 1916	\$ 2004
36"W x 18"D	YPC □ F223618BFL	\$ 1832	\$ 1923	\$ 2013	\$ 1912	\$ 2003	\$ 2093
36"W x 24"D	YPC □ F223624BFL	\$ 1950	\$ 2048	\$ 2145	\$ 2030	\$ 2128	\$ 2225
42"W x 18"D	YPC □ F224218BFL	\$ 1999	\$ 2099	\$ 2199	\$ 2079	\$ 2179	\$ 2279
42"W x 24"D	YPC □ F224224BFL	\$ 2128	\$ 2235	\$ 2342	\$ 2208	\$ 2315	\$ 2422

<p>How to specify — Select the Model Number from above.</p> <p>Y P </p> <p> </p>	<p>1st Option: Pull Option: A Arch S Square H Straight <i>Pulls are PR6 Silver, color not specified.</i></p> <p> .</p>	<p>2nd Option: Paint: C S See inside front cover for finishes.</p> <p>P .</p>	<p>3rd Option: Paint Shelf (if applicable): C S A Specify "NA" for shelf color to match case color; or specify a different Core, Select, or Accent paint and add \$73.</p> <p>P .</p>	<p>4th Option: Lock: L Lock X Omit Lock Core (Deduct \$18) <i>Lock is EL Silver, color not specified.</i></p> <p> .</p>
--	---	---	---	--

<p>5th Option: Laminate:</p> <p> </p>	<p>6th Option: Edge: Edge color is pre-determined by laminate selection.</p> <p> </p>	<p>7th Option: Foot Paint Color: C S See inside front cover for finishes. Stride feet are limited to PR6 Silver.</p> <p>P </p>
---	---	---

Examples: YPCTF224218RBFOLA.P02.P7E.L.LM14EW.P02 YPCZF222418BFLS.P28.X.LWZDZ.PR6

Align™ Metal Storage

Accessories

For specification information see pages 28-30.

GSA SIN 711-1

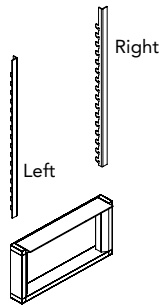

Description	Model	Core Paint P1 List Price	Select Paint P2 List Price
Storage-to-Panel Bracket Kits for 22"H Credenzas			
Left	AP22PBKLH	\$ 101	\$ 115
Right	AP22PBKRH	\$ 101	\$ 115

Worksurface Support Stanchions for use with 22"H Align Credenzas — PR6 Silver

12"D x 5"H for use on credenza with laminate top	APSS0512	\$ 325	\$ 348
12"D x 6"H for use on credenza without laminate top	APSS0612	\$ 325	\$ 348
18"D x 5"H for use on credenza with laminate top	APSS0518	\$ 338	\$ 361
18"D x 6"H for use on credenza without laminate top	APSS0618	\$ 338	\$ 361

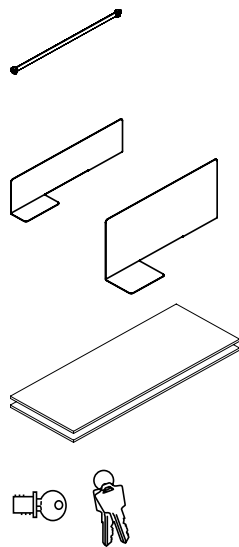

Description	Model	List Price
Front-to-Back Filing Bar for Credenzas		
12"D Hangrail Kit for 18"D Credenzas	YPCAHR12	\$ 18
15"D Hangrail Kit for 24"D Credenzas	YPCAHR15	\$ 29

Dividers for Credenzas

Box Drawer Dividers — 2 pack	YPCABD02	\$ 44
Box Drawer Dividers — 10 pack	YPCABD10	\$ 172
File Drawer Dividers — 2 pack	YPCAFD02	\$ 54
File Drawer Dividers — 10 pack	YPCAFD10	\$ 203

Counterweight Kits for Align 22"H Credenzas w/Drawers

25 lbs. for 42"W and 48"W Box/Lateral/Open unit	YPCACW25	\$ 172
35 lbs. for 24"W, 60"W, and 72"W Box/Lateral/Open unit	YPCACW35	\$ 228
50 lbs. for 30"W and 36"W Box/Lateral unit	YPCACW50	\$ 254
65 lbs. for 42"W Box/Lateral unit	YPCACW65	\$ 279

Matte Silver Removable Lock Core Kit

Key Numbers 101E-225E

Used on Align metal pedestals, credenzas, and towers. Includes one core, two keys, one core removal tool, adapter and instructions.

	ALKF26EL	\$ 18
--	----------	-------

Easy Lock Lock-Core — Reference Appendix page 182 for Easy Lock specification details.

Lock Core Kit Matte Silver — 1 core, 2 keys	LKFE1MTS	\$ 18
Lock Core Kit Matte Silver — 2 cores, 2 keys	LKFE2MTS	\$ 36
Lock Core Kit Matte Silver — 3 cores, 2 keys	LKFE3MTS	\$ 54
Lock Core Kit Matte Silver — 4 cores, 2 keys	LKFE4MTS	\$ 72
Lock Core Kit Matte Silver — 5 cores, 2 keys	LKFE5MTS	\$ 90
Lock Core Kit Matte Silver — 6 cores, 2 keys	LKFE6MTS	\$ 108
Lock Core Kit Matte Silver — 7 cores, 2 keys	LKFE7MTS	\$ 126
Lock Core Kit Matte Silver — 8 cores, 2 keys	LKFE8MTS	\$ 144

How to specify — Select the Model Number from above.	1st Option: Paint (if applicable):	1st Option: Key Type (if applicable): X Random X□□□ Number Specified SEQ /□□□ Sequential Keying	2nd Option: Quantity of Core Lock Kits (if applicable): See page 182 for details.
_____ . P _____		_____ .	_____

Examples: AP22PBKLH.P7B APSS0512.PR6 YPCAHR12 YPCACW25 ALKF26EL LKFE4MTS.X202.3

Shippable by small-package carrier.

For specification information see pages 28-30.

GSA SIN 711-1

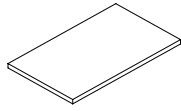

Description	Model	List Price										
		Grade 1	Grade 2	Grade 3	Grade 4	Grade 5	Grade 6	Grade 7	Grade 8	Grade L1	Grade L2	
Credenza Cushions for 18"D Credenzas												
24"W	[S] K5CT1824SC	\$ 232	\$ 265	\$ 284	\$ 308	\$ 329	\$ 349	\$ 372	\$ 393	\$ 451	\$ 611	
30"W	[S] K5CT1830SC	\$ 250	\$ 285	\$ 306	\$ 330	\$ 354	\$ 378	\$ 400	\$ 427	\$ 485	\$ 658	
36"W	K5CT1836SC	\$ 280	\$ 317	\$ 341	\$ 370	\$ 392	\$ 418	\$ 440	\$ 469	\$ 535	\$ 719	
42"W	K5CT1842SC	\$ 269	\$ 308	\$ 333	\$ 363	\$ 387	\$ 414	\$ 442	\$ 469	\$ 539	\$ 735	
48"W	K5CT1848SC	\$ 291	\$ 330	\$ 356	\$ 386	\$ 412	\$ 439	\$ 468	\$ 496	\$ 566	\$ 766	

COM Yardage: 0.7 yards (no vinyls), COL 7 sq.ft.

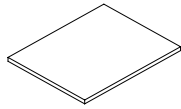

Description	Model	List Price										
		Grade 1	Grade 2	Grade 3	Grade 4	Grade 5	Grade 6	Grade 7	Grade 8	Grade L1	Grade L2	
Credenza Cushions for 24"D Credenzas												
24"W	K5CT2424SC	\$ 241	\$ 275	\$ 294	\$ 319	\$ 341	\$ 362	\$ 386	\$ 411	\$ 479	\$ 648	
30"W	K5CT2430SC	\$ 260	\$ 296	\$ 319	\$ 345	\$ 368	\$ 392	\$ 415	\$ 442	\$ 516	\$ 701	
36"W	K5CT2436SC	\$ 280	\$ 318	\$ 343	\$ 372	\$ 396	\$ 423	\$ 449	\$ 476	\$ 556	\$ 757	
48"W	K5CT2448SC	\$ 302	\$ 343	\$ 369	\$ 400	\$ 429	\$ 456	\$ 484	\$ 514	\$ 601	\$ 813	

COM Yardage: 0.9 yards (no vinyls), COL 8 sq.ft.

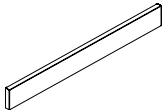

Description	Model	Core Paint	Select Paint
		P1 List Price	P2 List Price
Credenza Flush Kickplate Kits			
For 42"W Box/File/LH Open	YPCK42LBFO	[S] \$ 134	\$ 188
For 42"W Box/File/RH Open	YPCK42RBFO	[S] \$ 134	\$ 188
For 48"W Box/File/LH Open	YPCK48LBFO	[S] \$ 134	\$ 188
For 48"W Box/File/RH Open	YPCK48RBFO	[S] \$ 134	\$ 188
For 60"W Box/File/LH Open	YPCK60LBFO	[S] \$ 134	\$ 188
For 60"W Box/File/RH Open	YPCK60RBFO	[S] \$ 134	\$ 188
For 72"W Box/File/LH Open	YPCK72LBFO	[S] \$ 134	\$ 188
For 72"W Box/File/RH Open	YPCK72RBFO	[S] \$ 134	\$ 188
For 24"W Box/File	YPCK24BF	[S] \$ 134	\$ 188
For 30"W Box/File	YPCK30BF	[S] \$ 134	\$ 188
For 36"W Box/File	YPCK36BF	[S] \$ 134	\$ 188
For 42"W Box/File	YPCK42BF	[S] \$ 134	\$ 188
For 24"W Open	YPCK24O	[S] \$ 134	\$ 188
For 30"W Open	YPCK30O	[S] \$ 134	\$ 188
For 36"W Open	YPCK36O	[S] \$ 134	\$ 188
For 42"W Open	YPCK42O	[S] \$ 134	\$ 188

<p>How to specify — Select the Model Number from above.</p>	<p><i>1st Option:</i> Upholstery (if applicable): Specify seating upholstery. See Seating, Collaboration, and Tables Price List for available upholstery selection.</p>	<p><i>1st Option:</i> Paint (if applicable):</p>
<div style="display: flex; justify-content: space-between; border-top: 1px solid black; border-bottom: 1px solid black;"> _____ _____ _____ </div>	<div style="display: flex; justify-content: space-between; border-top: 1px solid black; border-bottom: 1px solid black;"> _____ _____ _____ </div>	<div style="display: flex; justify-content: space-between; border-top: 1px solid black; border-bottom: 1px solid black;"> _____ _____ _____ </div>

Examples: K5CT1824SC.PNS012 YPCK240.P7B

[S] Shippable by small-package carrier.

Align™ Metal Storage

28"H Laterals and Accessories

For specification information see pages 19, 25, and 31.

GSA SIN 711-3

ALIGN METAL SPEC

ALIGN PRICING

ESSENTIALS SPEC

ESSENTIALS PRICING

VERTICALS

INVOLVE SPEC

INVOLVE PRICING

ALIGN VENEER

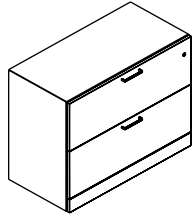

Description	Model – "BX" Recessed Base or – "BK" Flush Kickplate	Recessed Base "BX"		Flush Base "BK"	
		P1 Core	P2 Select	P1 Core	P2 Select
28"H Metal Case / Metal Fronts , two 12"H drawers with hanging frames for side-to-side or front-to-back filing					
30"W x 18"D	YPLB □ 283018FFM	\$ 1138	\$ 1238	\$ 1138	\$ 1238
36"W x 18"D	YPLB □ 283618FFM (shown)	\$ 1258	\$ 1358	\$ 1258	\$ 1358
42"W x 18"D	YPLB □ 284218FFM	\$ 1377	\$ 1477	\$ 1377	\$ 1477

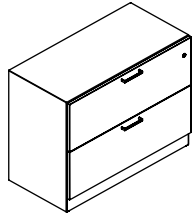

Width	Model	P1 Core Paint			P2 Select Paint		
		L1	L2	L3	L1	L2	L3
28"H Metal Case / Laminate Fronts , two 12"H drawers with hanging frames for side-to-side or front-to-back filing							
30"W x 18"D	YPLBX283018FFL	\$ 1387	\$ 1456	\$ 1525	\$ 1487	\$ 1556	\$ 1625
36"W x 18"D	YPLBX283618FFL (shown)	\$ 1542	\$ 1619	\$ 1696	\$ 1642	\$ 1719	\$ 1796
42"W x 18"D	YPLBX284218FFL	\$ 1685	\$ 1769	\$ 1853	\$ 1785	\$ 1869	\$ 1953

Note: Laminate front pull selection is limited to Arch, Square, or Straight pulls.

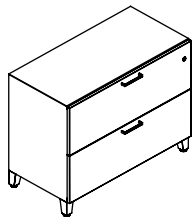

Description	Create Model — Add "T" or "Z": "TF" Terrace Feet, or "ZF" Stride Feet +\$63 extra	P1 Core Paint	P2 Select Paint
28"H Metal Case / Metal Fronts / Feet , two 12"H drawers with hanging frames for side-to-side or front-to-back filing			
30"W x 18"D	YPL □ F283018FFM	\$ 1274	\$ 1374
36"W x 18"D	YPL □ F283618FFM (shown)	\$ 1393	\$ 1493
42"W x 18"D	YPL □ F284218FFM	\$ 1512	\$ 1612

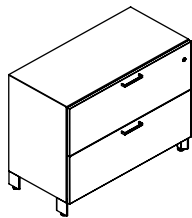

Width	Model	P1 Core Paint			P2 Select Paint		
		L1	L2	L3	L1	L2	L3
28"H Metal Case / Laminate Fronts / Feet , two 12"H drawers with hanging frames for side-to-side or front-to-back filing							
30"W x 18"D	YPL □ F283018FFL	\$ 1523	\$ 1598	\$ 1674	\$ 1623	\$ 1698	\$ 1774
36"W x 18"D	YPL □ F283618FFL (shown)	\$ 1678	\$ 1762	\$ 1846	\$ 1778	\$ 1862	\$ 1946
42"W x 18"D	YPL □ F284218FFL	\$ 1820	\$ 1911	\$ 2002	\$ 1920	\$ 2011	\$ 2102

Note: Laminate front pull selection is limited to Arch, Square, or Straight pulls.



Description	Model	List Price
Front-to-back Filing Bar		
15"D Hangrail Kit for 24"D Credenza or 18"D 2H Lateral	YPCAHR15 [5]	\$ 29

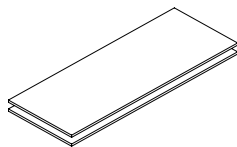

Counterweight Kits for Align 28"H Lateral Files		
50 lbs. for 30"W lateral	YPLACW50	\$ 254
57½ lbs. for 36"W lateral	YPLACW57	\$ 265
70 lbs. for 42"W lateral	YPLACW70	\$ 284

<p>How to specify — Select the Model Number from above.</p> <p>Y P L </p>	<p>1st Option: Pull: A Arch Pull S Square Pull H Straight Pulls are PR6 Silver, color not specified. B Beveled I Integral</p>	<p>2nd Option: Paint: C S See inside front cover for finishes.</p>	<p>3rd Option: Lock Type: L Standard Lock X Omit Lock Core (Deduct \$18 per lock)</p>	<p>4th Option: Laminate (if applicable):</p>	<p>5th Option: Edge: Edge color is predetermined by laminate selection.</p>	<p>6th Option: Foot Paint Color: C S See inside front cover for finishes. Stride feet are limited to PR6 Silver.</p>
	.	P .	.		.	

Examples: YPLBX283018FFMS.P02.L YPLACW50

[5] Shippable by small-package carrier.

For specification information see page 31.

GSA SIN 711-3

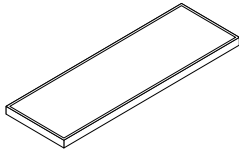

Width	Model	Surface Type (L=Laminate, W=Wood)	Laminate			Veneer		
			L1 List Price	L2 List Price	L3 List Price	V1 List Price	V3 List Price	V5 List Price
18"D Credenza and Lateral File Tops for Align and Essentials™								
24"W	AFNLFTP-2418	L or W	\$ 231	\$ 245	\$ 258	\$ 603	\$ 738	\$ 823
30"W	AFNLFTP-3018	L or W	\$ 255	\$ 268	\$ 282	\$ 641	\$ 699	\$ 779
36"W	AFNLFTP-3618	L or W	\$ 287	\$ 301	\$ 317	\$ 659	\$ 718	\$ 799
42"W	AFNLFTP-4218	L or W	\$ 313	\$ 329	\$ 346	\$ 684	\$ 747	\$ 834
48"W	AFNLFTP-4818	L or W	\$ 340	\$ 357	\$ 373	\$ 687	\$ 843	\$ 942
54½"W	AFNLFTP-5418	LS2 or WS2	\$ 343	\$ 359	\$ 376	\$ 706	\$ 863	\$ 964
60"W	AFNLFTP-6018	L or W	\$ 358	\$ 377	\$ 394	\$ 738	\$ 804	\$ 899
66½"W	AFNLFTP-6618	LS2 or WS2	\$ 370	\$ 387	\$ 405	\$ 736	\$ 897	\$ 999
72"W	AFNLFTP-7218	L or W	\$ 389	\$ 410	\$ 428	\$ 766	\$ 835	\$ 935
84"W	AFNLFTP-8418	L or W	\$ 511	\$ 538	\$ 562	\$ 813	\$ 888	\$ 988

24"D Credenza Tops for Align Credenzas

24"W	AFNLFTP-2424	L or W	\$ 315	\$ 333	\$ 352	\$ 756	\$ 947	\$ 1037
30"W	AFNLFTP-3024	L or W	\$ 344	\$ 363	\$ 383	\$ 783	\$ 980	\$ 1074
36"W	AFNLFTP-3624	L or W	\$ 388	\$ 409	\$ 431	\$ 808	\$ 1011	\$ 1108
42"W	AFNLFTP-4224	L or W	\$ 421	\$ 443	\$ 466	\$ 867	\$ 1083	\$ 1184
48"W	AFNLFTP-4824	L or W	\$ 451	\$ 474	\$ 499	\$ 883	\$ 1102	\$ 1205
54½"W	AFNLFTP-5424	LS2 or WS2	\$ 468	\$ 491	\$ 516	\$ 900	\$ 1122	\$ 1226
60"W	AFNLFTP-6024	L or W	\$ 483	\$ 507	\$ 533	\$ 917	\$ 1142	\$ 1248
60½"W	AFNLFTP-6024	LS2 or WS2	\$ 483	\$ 507	\$ 533	\$ 917	\$ 1142	\$ 1248
66½"W	AFNLFTP-6624	LS2 or WS2	\$ 505	\$ 529	\$ 555	\$ 932	\$ 1159	\$ 1267
72"W	AFNLFTP-7224	L or W	\$ 523	\$ 548	\$ 574	\$ 954	\$ 1185	\$ 1294
72½"W	AFNLFTP-7224	LS2 or WS2	\$ 523	\$ 548	\$ 574	\$ 954	\$ 1185	\$ 1294
84"W	AFNLFTP-8424	L or W	\$ 687	\$ 714	\$ 743	\$ 998	\$ 1235	\$ 1348
84½"W	AFNLFTP-8424	LS2 or WS2	\$ 687	\$ 714	\$ 743	\$ 998	\$ 1235	\$ 1348

36"D Lateral File Tops for Align and Essentials Lateral Files

24"W	AFNLFTP-2436	L or W	\$ 403	\$ 423	\$ 443	\$ 909	\$ 1114	\$ 1216
30"W	AFNLFTP-3036	L or W	\$ 444	\$ 468	\$ 488	\$ 954	\$ 1155	\$ 1290
36"W	AFNLFTP-3636	L or W	\$ 503	\$ 530	\$ 552	\$ 988	\$ 1197	\$ 1337
42"W	AFNLFTP-4236	L or W	\$ 544	\$ 573	\$ 598	\$ 1083	\$ 1314	\$ 1467
48"W	AFNLFTP-4836	L or W	\$ 567	\$ 592	\$ 618	\$ 1078	\$ 1314	\$ 1433
54½"W	AFNLFTP-5436	LS2 or WS2	\$ 592	\$ 618	\$ 644	\$ 1095	\$ 1334	\$ 1454
60"W	AFNLFTP-6036	L or W	\$ 627	\$ 660	\$ 688	\$ 1131	\$ 1369	\$ 1530
66½"W	AFNLFTP-6636	LS2 or WS2	\$ 639	\$ 666	\$ 693	\$ 1128	\$ 1372	\$ 1494
72"W	AFNLFTP-7236	L or W	\$ 676	\$ 711	\$ 741	\$ 1177	\$ 1428	\$ 1595
84"W	AFNLFTP-8436	L or W	\$ 889	\$ 933	\$ 977	\$ 1221	\$ 1482	\$ 1653

Particle board construction with laminate and flat edge trim on all sides or veneer surface and veneer edge on all sides.

Note: Add Suffix "S2" to 54"W - 84"W model numbers to add ½" to nominal width of top to span 2 storage units - no upcharge.

<p>How to specify — Select the Model Number from above.</p>	<p>1st Option: Laminate or Veneer Type and Finish: See inside front cover for finishes.</p> <p>S prefix for Stratawood N prefix for Natural</p>	<p>2nd Option: Edge: (on laminate tops only) See inside front cover for finishes.</p>
--	---	---

Examples: AFNLFTP-3018L.LT3B.E9 AFNLFTP-5418LS2.LT3B.E9

Shippable by small-package carrier.



Align™ Metal Storage

Front and Side Access Towers

For specification information see pages 20-22 and 32.

Metal Fronts with Plinth Base

GSA SIN 711-3

Description	New Model — Add "X" or "K" "BX" Recessed Base "BK" Flush Kickplate	Core	Select
		Paint P1 List Price	Paint P2 List Price
42½"H Personal Towers — 24"W x 24"D — Metal Case/Metal Fronts			
Wardrobe Left / Door/File/File	YPTB □ 422424LFFM	\$ 2084	\$ 2219
Wardrobe Right / Door/File/File	YPTB □ 422424RFFM	\$ 2084	\$ 2219
Wardrobe Left / Door/Box/Box/File	YPTB □ 422424LBBFM	\$ 2084	\$ 2219
Wardrobe Right / Door/Box/Box/File (shown)	YPTB □ 422424RBBFM	\$ 2084	\$ 2219
50"H Personal Towers — 24"W x 24"D — Metal Case/Metal Fronts			
Wardrobe Left / Door/File/File (shown)	YPTB □ 502424LFFM	\$ 2084	\$ 2219
Wardrobe Right / Door/File/File	YPTB □ 502424RFFM	\$ 2084	\$ 2219
Wardrobe Left / Door/Box/Box/File	YPTB □ 502424LBBFM	\$ 2084	\$ 2219
Wardrobe Right / Door/Box/Box/File	YPTB □ 502424RBBFM	\$ 2084	\$ 2219
57½"H Personal Towers — 24"W x 24"D — Metal Case/Metal Fronts			
Wardrobe Left / Door/File/File	YPTB □ 572424LFFM	\$ 2533	\$ 2718
Wardrobe Right / Door/File/File (shown)	YPTB □ 572424RFFM	\$ 2533	\$ 2718
Wardrobe Left / Door/Box/Box/File	YPTB □ 572424LBBFM	\$ 2533	\$ 2718
Wardrobe Right / Door/Box/Box/File	YPTB □ 572424RBBFM	\$ 2533	\$ 2718
65"H Personal Towers — 24"W x 24"D — Metal Case/Metal Fronts			
Wardrobe Left / Door/File/File	YPTB □ 652424LFFM	\$ 2533	\$ 2718
Wardrobe Right / Door/File/File	YPTB □ 652424RFFM	\$ 2533	\$ 2718
Wardrobe Left / Door/Box/Box/File (shown)	YPTB □ 652424LBBFM	\$ 2533	\$ 2718
Wardrobe Right / Door/Box/Box/File	YPTB □ 652424RBBFM	\$ 2533	\$ 2718
42½"H Side Access Personal Towers — 24"W x 24"D — Metal Case/Metal Fronts			
Wardrobe Left / File/File	YPTSB □ 422424LFFM	\$ 2176	\$ 2311
Wardrobe Right / File/File (shown)	YPTSB □ 422424RFFM	\$ 2176	\$ 2311
Wardrobe Left / Box/Box/File	YPTSB □ 422424LBBFM	\$ 2176	\$ 2311
Wardrobe Right / Box/Box/File	YPTSB □ 422424RBBFM	\$ 2176	\$ 2311
50"H Side Access Personal Towers — 24"W x 24"D — Metal Case/Metal Fronts			
Wardrobe Left / File/File	YPTSB □ 502424LFFM	\$ 2176	\$ 2311
Wardrobe Right / File/File	YPTSB □ 502424RFFM	\$ 2176	\$ 2311
Wardrobe Left / Box/Box/File	YPTSB □ 502424LBBFM	\$ 2176	\$ 2311
Wardrobe Right / Box/Box/File (shown)	YPTSB □ 502424RBBFM	\$ 2176	\$ 2311
57½"H Side Access Personal Towers — 24"W x 24"D — Metal Case/Metal Fronts			
Wardrobe Left / File/File	YPTSB □ 572424LFFM	\$ 2671	\$ 2856
Wardrobe Right / File/File	YPTSB □ 572424RFFM	\$ 2671	\$ 2856
Wardrobe Left / Box/Box/File	YPTSB □ 572424LBBFM	\$ 2671	\$ 2856
Wardrobe Right / Box/Box/File (shown)	YPTSB □ 572424RBBFM	\$ 2671	\$ 2856
65"H Side Access Personal Towers — 24"W x 24"D — Metal Case/Metal Fronts			
Wardrobe Left / File/File	YPTSB □ 652424LFFM	\$ 2671	\$ 2856
Wardrobe Right / File/File	YPTSB □ 652424RFFM	\$ 2671	\$ 2856
Wardrobe Left / Box/Box/File	YPTSB □ 652424LBBFM	\$ 2671	\$ 2856
Wardrobe Right / Box/Box/File (shown)	YPTSB □ 652424RBBFM	\$ 2671	\$ 2856
Tower Flush Kickplate Kits			
For 24"W Tower — Ped Right	YPTAKR □ 	\$ 130	\$ 142
For 24"W Tower — Ped Left	YPTAKL □ 	\$ 130	\$ 142

How to specify —
Select the
Model Number
from above.

Y P T

1st Option:
Pull Option
(if applicable):

A Arch
B Bevel
S Square
H Straight
I Integral
Pulls are PR6 Silver,
color not specified.

2nd Option:

Paint:
 

P

3rd Option:

Lock
(if applicable):

L Lock
X Omit Lock Core
(Deduct \$18)
Lock is EL Silver,
color not specified.

Examples: YPTBK652424LFFMS.P02.L
YPTSBX652424RBBFMH.PR5.X

 Shippable by small-package carrier.

For specification information see pages 20-22 and 32.

Laminate Fronts with Plinth Base

GSA SIN 711-3

Width	Model	P1 Core Paint			P2 Select Paint		
		L1	L2	L3	L1	L2	L3
42½"H Personal Towers — 24"W x 24"D — Metal Case/Laminate Fronts							
Wardrobe Left / Door/File/File	YPTBX422424LFFL	\$ 2350	\$ 2470	\$ 2591	\$ 2485	\$ 2605	\$ 2726
Wardrobe Right / Door/File/File	YPTBX422424RFFL	\$ 2350	\$ 2470	\$ 2591	\$ 2485	\$ 2605	\$ 2726
Wardrobe Left / Door/Box/Box/File	YPTBX422424LBBFL	\$ 2387	\$ 2509	\$ 2631	\$ 2522	\$ 2644	\$ 2766
Wardrobe Right / Door/Box/Box/File (shown)	YPTBX422424RBBFL	\$ 2387	\$ 2509	\$ 2631	\$ 2522	\$ 2644	\$ 2766
50"H Personal Towers — 24"W x 24"D — Metal Case/Laminate Fronts							
Wardrobe Left / Door/File/File (shown)	YPTBX502424LFFL	\$ 2360	\$ 2481	\$ 2602	\$ 2495	\$ 2616	\$ 2737
Wardrobe Right / Door/File/File	YPTBX502424RFFL	\$ 2360	\$ 2481	\$ 2602	\$ 2495	\$ 2616	\$ 2737
Wardrobe Left / Door/Box/Box/File	YPTBX502424LBBFL	\$ 2403	\$ 2526	\$ 2650	\$ 2538	\$ 2661	\$ 2785
Wardrobe Right / Door/Box/Box/File	YPTBX502424RBBFL	\$ 2403	\$ 2526	\$ 2650	\$ 2538	\$ 2661	\$ 2785
57½"H Personal Towers — 24"W x 24"D — Metal Case/Laminate Fronts							
Wardrobe Left / Door/File/File	YPTBX572424LFFL	\$ 2885	\$ 3034	\$ 3183	\$ 3070	\$ 3219	\$ 3368
Wardrobe Right / Door/File/File (shown)	YPTBX572424RFFL	\$ 2885	\$ 3034	\$ 3183	\$ 3070	\$ 3219	\$ 3368
Wardrobe Left / Door/Box/Box/File	YPTBX572424LBBFL	\$ 2919	\$ 3070	\$ 3220	\$ 3104	\$ 3255	\$ 3405
Wardrobe Right / Door/Box/Box/File	YPTBX572424RBBFL	\$ 2919	\$ 3070	\$ 3220	\$ 3104	\$ 3255	\$ 3405
65"H Personal Towers — 24"W x 24"D — Metal Case/Laminate Fronts							
Wardrobe Left / Door/File/File	YPTBX652424LFFL	\$ 2996	\$ 3150	\$ 3305	\$ 3181	\$ 3335	\$ 3490
Wardrobe Right / Door/File/File	YPTBX652424RFFL	\$ 2996	\$ 3150	\$ 3305	\$ 3181	\$ 3335	\$ 3490
Wardrobe Left / Door/Box/Box/File (shown)	YPTBX652424LBBFL	\$ 3039	\$ 3196	\$ 3353	\$ 3221	\$ 3381	\$ 3538
Wardrobe Right / Door/Box/Box/File	YPTBX652424RBBFL	\$ 3039	\$ 3196	\$ 3353	\$ 3221	\$ 3381	\$ 3538
42½"H Side Access Personal Towers — 24"W x 24"D — Metal Case/Laminate Fronts							
Wardrobe Left / File/File	YPTSXB422424LFFL	\$ 2446	\$ 2566	\$ 2687	\$ 2581	\$ 2701	\$ 2822
Wardrobe Right / File/File (shown)	YPTSXB422424RFFL	\$ 2446	\$ 2566	\$ 2687	\$ 2581	\$ 2701	\$ 2822
Wardrobe Left / Box/Box/File	YPTSXB422424LBBFL	\$ 2483	\$ 2605	\$ 2727	\$ 2618	\$ 2740	\$ 2862
Wardrobe Right / Box/Box/File	YPTSXB422424RBBFL	\$ 2483	\$ 2605	\$ 2727	\$ 2618	\$ 2740	\$ 2862
50"H Side Access Personal Towers — 24"W x 24"D — Metal Case/Laminate Fronts							
Wardrobe Left / File/File	YPTSXB502424LFFL	\$ 2456	\$ 2577	\$ 2698	\$ 2591	\$ 2712	\$ 2833
Wardrobe Right / File/File	YPTSXB502424RFFL	\$ 2456	\$ 2577	\$ 2698	\$ 2591	\$ 2712	\$ 2833
Wardrobe Left / Box/Box/File	YPTSXB502424LBBFL	\$ 2500	\$ 2623	\$ 2747	\$ 2635	\$ 2758	\$ 2882
Wardrobe Right / Box/Box/File (shown)	YPTSXB502424RBBFL	\$ 2500	\$ 2623	\$ 2747	\$ 2635	\$ 2758	\$ 2882
57½"H Side Access Personal Towers — 24"W x 24"D — Metal Case/Laminate Fronts							
Wardrobe Left / File/File	YPTSXB572424LFFL	\$ 3000	\$ 3149	\$ 3298	\$ 3185	\$ 3334	\$ 3483
Wardrobe Right / File/File	YPTSXB572424RFFL	\$ 3000	\$ 3149	\$ 3298	\$ 3185	\$ 3334	\$ 3483
Wardrobe Left / Box/Box/File	YPTSXB572424LBBFL	\$ 3043	\$ 3194	\$ 3344	\$ 3228	\$ 3379	\$ 3529
Wardrobe Right / Box/Box/File (shown)	YPTSXB572424RBBFL	\$ 3043	\$ 3194	\$ 3344	\$ 3228	\$ 3379	\$ 3529
65"H Side Access Personal Towers — 24"W x 24"D — Metal Case/Laminate Fronts							
Wardrobe Left / File/File	YPTSXB652424LFFL	\$ 3103	\$ 3257	\$ 3412	\$ 3288	\$ 3442	\$ 3597
Wardrobe Right / File/File (shown)	YPTSXB652424RFFL	\$ 3103	\$ 3313	\$ 3470	\$ 3288	\$ 3442	\$ 3597
Wardrobe Left / Box/Box/File	YPTSXB652424LBBFL	\$ 3156	\$ 3313	\$ 3470	\$ 3341	\$ 3498	\$ 3655
Wardrobe Right / Box/Box/File	YPTSXB652424RBBFL	\$ 3156	\$ 3313	\$ 3470	\$ 3341	\$ 3498	\$ 3655
Shelf — Bottom shelf without bracket for freestanding Side Access Personal Tower							
Shelf for Side Access Tower — 22½"W x 13¾"D	YPSTBS24 [5]		\$ 74	\$ 88			

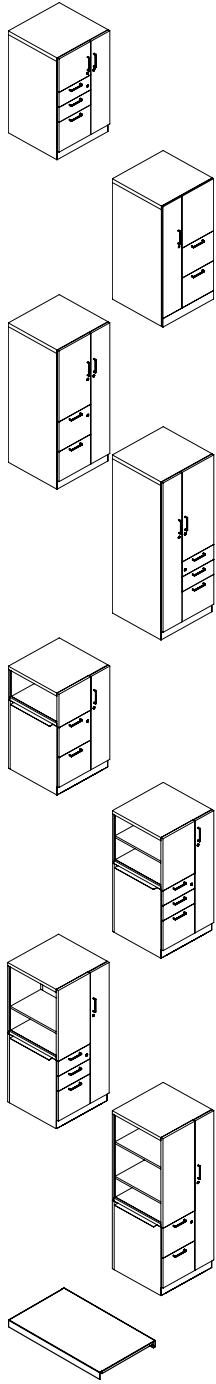

<p>How to specify — Select the Model Number from above.</p> <p>YIP </p>	<p>1st Option: Pull Option (if applicable):</p> <p>A Arch S Square H Straight</p> <p>Pulls are PR6 Silver, color not specified.</p>	<p>2nd Option: Paint:</p> <p>See inside front cover for finishes.</p>	<p>3rd Option: Lock (if applicable):</p> <p>L Lock X Omit Lock Core (Deduct \$18 per lock)</p> <p>Lock is EL Silver, color not specified.</p>	<p>4th Option: Laminate (if applicable):</p> <p>See inside front cover for finishes.</p>	<p>5th Option: Edge (if applicable):</p> <p>Edge color is pre-determined by laminate selection.</p>
--	---	---	--	--	---

Examples: YPTBX422424LFFLA.P02.L.LM14EW YPTSXB652424LFFL.PQ8.X.LM14EW [5] Shippable by small-package carrier. allsteeloffice.com | 47

Align™ Metal Storage

For specification information see pages 20-22 and 32.

Front and Side Access Towers

Metal Fronts with Terrace or Stride Feet

GSA SIN 711-3

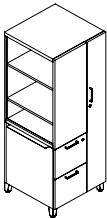
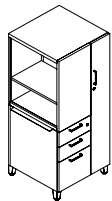
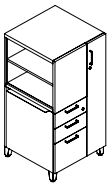
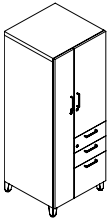
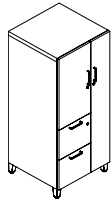
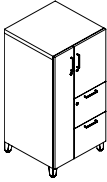

Description	Create Model — Add "T" or "Z": "TF" Terrace Feet, or "ZF" Stride Feet +\$63 extra	Core Paint		Select
		P1 List Price	P2 List Price	Paint
42½"H Personal Towers — 24"W x 24"D — Metal Case/Metal Fronts				
Wardrobe Left / Door/File/File	YPT □ F422424LFFM	\$ 2250	\$ 2385	
Wardrobe Right / Door/File/File	YPT □ F422424RFFM	\$ 2250	\$ 2385	
Wardrobe Left / Door/Box/Box/File	YPT □ F422424LBFFM	\$ 2250	\$ 2385	
Wardrobe Right / Door/Box/Box/File (shown)	YPT □ F422424RBFFM	\$ 2250	\$ 2385	
50"H Personal Towers — 24"W x 24"D — Metal Case/Metal Fronts				
Wardrobe Left / Door/File/File (shown)	YPT □ F502424LFFM	\$ 2250	\$ 2385	
Wardrobe Right / Door/File/File	YPT □ F502424RFFM	\$ 2250	\$ 2385	
Wardrobe Left / Door/Box/Box/File	YPT □ F502424LBFFM	\$ 2250	\$ 2385	
Wardrobe Right / Door/Box/Box/File	YPT □ F502424RBFFM	\$ 2250	\$ 2385	
57½"H Personal Towers — 24"W x 24"D — Metal Case/Metal Fronts				
Wardrobe Left / Door/File/File	YPT □ F572424LFFM	\$ 2705	\$ 2890	
Wardrobe Right / Door/File/File (shown)	YPT □ F572424RFFM	\$ 2705	\$ 2890	
Wardrobe Left / Door/Box/Box/File	YPT □ F572424LBFFM	\$ 2705	\$ 2890	
Wardrobe Right / Door/Box/Box/File	YPT □ F572424RBFFM	\$ 2705	\$ 2890	
65"H Personal Towers — 24"W x 24"D — Metal Case/Metal Fronts				
Wardrobe Left / Door/File/File	YPT □ F652424LFFM	\$ 2705	\$ 2890	
Wardrobe Right / Door/File/File	YPT □ F652424RFFM	\$ 2705	\$ 2890	
Wardrobe Left / Door/Box/Box/File (shown)	YPT □ F652424LBFFM	\$ 2705	\$ 2890	
Wardrobe Right / Door/Box/Box/File	YPT □ F652424RBFFM	\$ 2705	\$ 2890	
42½"H Side Access Personal Towers — 24"W x 24"D — Metal Case/Metal Fronts				
Wardrobe Left / File/File	YPTS □ F422424LFFM	\$ 2311	\$ 2446	
Wardrobe Right / File/File (shown)	YPTS □ F422424RFFM	\$ 2311	\$ 2446	
Wardrobe Left / Box/Box/File	YPTS □ F422424LBFFM	\$ 2311	\$ 2446	
Wardrobe Right / Box/Box/File	YPTS □ F422424RBFFM	\$ 2311	\$ 2446	
50"H Side Access Personal Towers — 24"W x 24"D — Metal Case/Metal Fronts				
Wardrobe Left / File/File	YPTS □ F502424LFFM	\$ 2311	\$ 2446	
Wardrobe Right / File/File	YPTS □ F502424RFFM	\$ 2311	\$ 2446	
Wardrobe Left / Box/Box/File	YPTS □ F502424LBFFM	\$ 2311	\$ 2446	
Wardrobe Right / Box/Box/File (shown)	YPTS □ F502424RBFFM	\$ 2311	\$ 2446	
57½"H Side Access Personal Towers — 24"W x 24"D — Metal Case/Metal Fronts				
Wardrobe Left / File/File	YPTS □ F572424LFFM	\$ 2806	\$ 2991	
Wardrobe Right / File/File	YPTS □ F572424RFFM	\$ 2806	\$ 2991	
Wardrobe Left / Box/Box/File	YPTS □ F572424LBFFM	\$ 2806	\$ 2991	
Wardrobe Right / Box/Box/File (shown)	YPTS □ F572424RBFFM	\$ 2806	\$ 2991	
65"H Side Access Personal Towers — 24"W x 24"D — Metal Case/Metal Fronts				
Wardrobe Left / File/File	YPTS □ F652424LFFM	\$ 2806	\$ 2991	
Wardrobe Right / File/File (shown)	YPTS □ F652424RFFM	\$ 2806	\$ 2991	
Wardrobe Left / Box/Box/File	YPTS □ F652424LBFFM	\$ 2806	\$ 2991	
Wardrobe Right / Box/Box/File	YPTS □ F652424RBFFM	\$ 2806	\$ 2991	

How to specify —
Select the Model Number from above.

Y P T | | | | | | | | | | | | | | | |

1st Option:
Pull Option:

- A Arch
 - B Bevel
 - S Square
 - H Straight
 - I Integral
- Pulls are PR6 Silver, color not specified.

2nd Option:
Paint:

See inside front cover for finishes.

3rd Option:
Lock:

- L Lock
 - X Omit Lock Core (Deduct \$18 per lock)
- Lock is EL Silver, color not specified.

4th Option:
Foot Paint Color:

- ⓐ ⓑ
- See inside front cover for finishes. Stride feet are limited to PR6 Silver.

P | | | | |

Examples: YPTZF422424LFFMS.P02.L.PR6
YPTSTF502424LFFMH.P7B.X.P7B

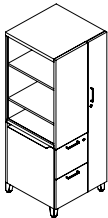
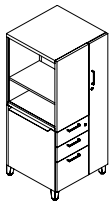
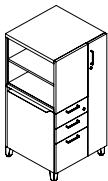
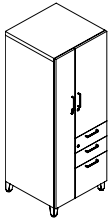
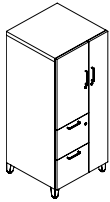
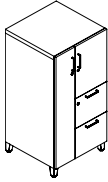

Width	Create Model — Add “T” or “Z”: “TF” Terrace Feet, or “ZF” Stride Feet +\$63 extra	P1 Core Paint			P2 Select Paint		
		L1	L2	L3	L1	L2	L3

42½"H Personal Towers — 24"W x 24"D – Metal Case/Laminate Fronts							
Wardrobe Left / Door/File/File	YPT <input type="checkbox"/> F422424LFFFL	\$ 2519	\$ 2639	\$ 2760	\$ 2654	\$ 2774	\$ 2895
Wardrobe Right / Door/File/File	YPT <input type="checkbox"/> F422424RFFFL	\$ 2519	\$ 2639	\$ 2760	\$ 2654	\$ 2774	\$ 2895
Wardrobe Left / Door/Box/Box/File	YPT <input type="checkbox"/> F422424LBBFL	\$ 2557	\$ 2679	\$ 2801	\$ 2692	\$ 2814	\$ 2936
Wardrobe Right / Door/Box/Box/File (shown)	YPT <input type="checkbox"/> F422424RBBFL	\$ 2557	\$ 2679	\$ 2801	\$ 2692	\$ 2814	\$ 2936

50"H Personal Towers — 24"W x 24"D – Metal Case/Laminate Fronts							
Wardrobe Left / Door/File/File (shown)	YPT <input type="checkbox"/> F502424LFFFL	\$ 2530	\$ 2651	\$ 2772	\$ 2665	\$ 2786	\$ 2907
Wardrobe Right / Door/File/File	YPT <input type="checkbox"/> F502424RFFFL	\$ 2530	\$ 2651	\$ 2772	\$ 2665	\$ 2786	\$ 2907
Wardrobe Left / Door/Box/Box/File	YPT <input type="checkbox"/> F502424LBBFL	\$ 2573	\$ 2696	\$ 2820	\$ 2708	\$ 2831	\$ 2955
Wardrobe Right / Door/Box/Box/File	YPT <input type="checkbox"/> F502424RBBFL	\$ 2573	\$ 2696	\$ 2820	\$ 2708	\$ 2831	\$ 2955

57½"H Personal Towers — 24"W x 24"D – Metal Case/Laminate Fronts							
Wardrobe Left / Door/File/File	YPT <input type="checkbox"/> F572424LFFFL	\$ 3062	\$ 3211	\$ 3360	\$ 3247	\$ 3396	\$ 3545
Wardrobe Right / Door/File/File (shown)	YPT <input type="checkbox"/> F572424RFFFL	\$ 3062	\$ 3211	\$ 3360	\$ 3247	\$ 3396	\$ 3545
Wardrobe Left / Door/Box/Box/File	YPT <input type="checkbox"/> F572424LBBFL	\$ 3097	\$ 3248	\$ 3398	\$ 3282	\$ 3433	\$ 3583
Wardrobe Right / Door/Box/Box/File	YPT <input type="checkbox"/> F572424RBBFL	\$ 3097	\$ 3248	\$ 3398	\$ 3282	\$ 3433	\$ 3583

65"H Personal Towers — 24"W x 24"D – Metal Case/Laminate Fronts							
Wardrobe Left / Door/File/File	YPT <input type="checkbox"/> F652424LFFFL	\$ 3175	\$ 3329	\$ 3484	\$ 3360	\$ 3514	\$ 3669
Wardrobe Right / Door/File/File	YPT <input type="checkbox"/> F652424RFFFL	\$ 3175	\$ 3329	\$ 3484	\$ 3360	\$ 3514	\$ 3669
Wardrobe Left / Door/Box/Box/File (shown)	YPT <input type="checkbox"/> F652424LBBFL	\$ 3218	\$ 3375	\$ 3532	\$ 3403	\$ 3560	\$ 3717
Wardrobe Right / Door/Box/Box/File	YPT <input type="checkbox"/> F652424RBBFL	\$ 3218	\$ 3375	\$ 3532	\$ 3403	\$ 3560	\$ 3717

42½"H Side Access Personal Towers — 24"W x 24"D – Metal Case/Laminate Fronts							
Wardrobe Left / File/File	YPTS <input type="checkbox"/> F422424LFFFL	\$ 2581	\$ 2710	\$ 2839	\$ 2716	\$ 2875	\$ 2974
Wardrobe Right / File/File (shown)	YPTS <input type="checkbox"/> F422424RFFFL	\$ 2581	\$ 2710	\$ 2839	\$ 2716	\$ 2875	\$ 2974
Wardrobe Left / Box/Box/File	YPTS <input type="checkbox"/> F422424LBBFL	\$ 2618	\$ 2748	\$ 2879	\$ 2753	\$ 2883	\$ 3014
Wardrobe Right / Box/Box/File	YPTS <input type="checkbox"/> F422424RBBFL	\$ 2618	\$ 2748	\$ 2879	\$ 2753	\$ 2883	\$ 3014

50"H Side Access Personal Towers — 24"W x 24"D – Metal Case/Laminate Fronts							
Wardrobe Left / File/File	YPTS <input type="checkbox"/> F502424LFFFL	\$ 2591	\$ 2720	\$ 2850	\$ 2726	\$ 2855	\$ 2985
Wardrobe Right / File/File	YPTS <input type="checkbox"/> F502424RFFFL	\$ 2591	\$ 2720	\$ 2850	\$ 2726	\$ 2855	\$ 2985
Wardrobe Left / Box/Box/File	YPTS <input type="checkbox"/> F502424LBBFL	\$ 2635	\$ 2766	\$ 2898	\$ 2770	\$ 2901	\$ 3033
Wardrobe Right / Box/Box/File (shown)	YPTS <input type="checkbox"/> F502424RBBFL	\$ 2635	\$ 2766	\$ 2898	\$ 2770	\$ 2901	\$ 3033

57½"H Side Access Personal Towers — 24"W x 24"D – Metal Case/Laminate Fronts							
Wardrobe Left / File/File	YPTS <input type="checkbox"/> F572424LFFFL	\$ 3134	\$ 3290	\$ 3448	\$ 3319	\$ 3475	\$ 3633
Wardrobe Right / File/File	YPTS <input type="checkbox"/> F572424RFFFL	\$ 3134	\$ 3290	\$ 3448	\$ 3319	\$ 3475	\$ 3633
Wardrobe Left / Box/Box/File	YPTS <input type="checkbox"/> F572424LBBFL	\$ 3178	\$ 3336	\$ 3496	\$ 3363	\$ 3521	\$ 3681
Wardrobe Right / Box/Box/File (shown)	YPTS <input type="checkbox"/> F572424RBBFL	\$ 3178	\$ 3336	\$ 3496	\$ 3363	\$ 3521	\$ 3681

65"H Side Access Personal Towers — 24"W x 24"D – Metal Case/Laminate Fronts							
Wardrobe Left / File/File	YPTS <input type="checkbox"/> F652424LFFFL	\$ 3238	\$ 3399	\$ 3562	\$ 3423	\$ 3584	\$ 3747
Wardrobe Right / File/File (shown)	YPTS <input type="checkbox"/> F652424RFFFL	\$ 3238	\$ 3399	\$ 3562	\$ 3423	\$ 3584	\$ 3747
Wardrobe Left / Box/Box/File	YPTS <input type="checkbox"/> F652424LBBFL	\$ 3291	\$ 3454	\$ 3620	\$ 3476	\$ 3639	\$ 3805
Wardrobe Right / Box/Box/File	YPTS <input type="checkbox"/> F652424RBBFL	\$ 3291	\$ 3454	\$ 3620	\$ 3476	\$ 3639	\$ 3805

<p>How to specify — Select the Model Number from above.</p> <p>Y P T </p>	<p>1st Option: Pull Option: A Arch S Square H Straight <i>Pulls are PR6 Silver, color not specified.</i></p> <p> .</p>	<p>2nd Option: Paint: See inside front cover for finishes.</p> <p>P .</p>	<p>3rd Option: Lock: L Lock X Omit Lock Core (Deduct \$18) <i>Lock is EL Silver, color not specified.</i></p> <p> .</p>	<p>4th Option: Laminate: See inside front cover for finishes.</p> <p> .</p>	<p>5th Option: Edge: Edge color is pre-determined by laminate selection.</p> <p> .</p>	<p>6th Option: Foot Paint Color: G S See inside front cover for finishes. Stride feet are limited to PR6 Silver.</p> <p>P </p>
---	---	---	--	--	---	---

Example: YPTSTF422424LFFFLS.PQ8.L.LM14EW.P7B

Align™ Metal Storage

12"W Wardrobe / Lockers and Accessories

For specification information see pages 23 and 33.

Metal Fronts with Plinth Base or Footed

GSA SIN 711-3

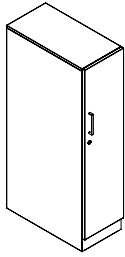

Description	Create Model — Add "X" or "K": "BX" Recessed Base, or "BK" Flush Kickplate	Core	Select
		Paint P1 List Price	Paint P2 List Price
42½"H Wardrobe / Lockers — 12"W — Metal Case/Metal Front			
18"D Wardrobe Hinges on Left	YPWTB □ 421218L	\$ 1351	\$ 1432
18"D Wardrobe Hinges on Right	YPWTB □ 421218R	\$ 1351	\$ 1432
24"D Wardrobe Hinges on Left	YPWTB □ 421224L	\$ 1428	\$ 1513
24"D Wardrobe Hinges on Right (shown)	YPWTB □ 421224R	\$ 1428	\$ 1513
50"H Wardrobe / Lockers — 12"W — Metal Case/Metal Front			
18"D Wardrobe Hinges on Left	YPWTB □ 501218L	\$ 1408	\$ 1492
18"D Wardrobe Hinges on Right	YPWTB □ 501218R	\$ 1408	\$ 1492
24"D Wardrobe Hinges on Left	YPWTB □ 501224L	\$ 1488	\$ 1577
24"D Wardrobe Hinges on Right	YPWTB □ 501224R	\$ 1488	\$ 1577

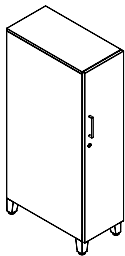

Description	Create Model — Add "T" or "Z": "TF" Terrace Feet, or "ZF" Stride Feet +\$63 extra	Core	Select
		Paint P1 List Price	Paint P2 List Price
42½"H Wardrobe / Lockers — 12"W — Metal Case/Metal Front			
18"D Wardrobe Hinges on Left	YPWT □ F421218L	\$ 1476	\$ 1568
18"D Wardrobe Hinges on Right	YPWT □ F421218R	\$ 1476	\$ 1568
24"D Wardrobe Hinges on Left	YPWT □ F421224L	\$ 1574	\$ 1659
24"D Wardrobe Hinges on Right (shown)	YPWT □ F421224R	\$ 1574	\$ 1659
50"H Wardrobe / Lockers — 12"W — Metal Case/Metal Front			
18"D Wardrobe Hinges on Left	YPWT □ F501218L	\$ 1533	\$ 1628
18"D Wardrobe Hinges on Right	YPWT □ F501218R	\$ 1533	\$ 1628
24"D Wardrobe Hinges on Left	YPWT □ F501224L	\$ 1635	\$ 1724
24"D Wardrobe Hinges on Right	YPWT □ F501224R	\$ 1635	\$ 1724

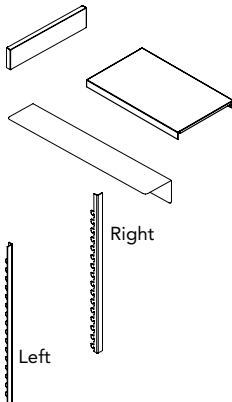

Description	Model	Core Paint P1 List Price	Select Paint P2 List Price
Accessories for 12"W Wardrobe / Lockers			
Field Installable Kickplate for 12"W Wardrobe	YPWTAKP	\$ 72	\$ 78
Field Installable Shelf for 12"W x 18"D Wardrobe	YPWTASHELF18	\$ 113	\$ 121
Field Installable Shelf for 12"W x 24"D Wardrobe	YPWTASHELF24	\$ 117	\$ 125
18"D Wardrobe Tower to Worksurface Bracket	YPWTAWSBKT18	\$ 63	\$ 70
24"D Wardrobe Tower to Worksurface Bracket	YPWTAWSBKT24	\$ 66	\$ 73
Panel Mounting Bracket — Left-Hand	AP22PBKLN	\$ 101	\$ 115
Panel Mounting Bracket — Right-Hand	AP22PBKRH	\$ 101	\$ 115

<p>How to specify — Select the Model Number from above.</p> <p>_____</p> <p>_____</p>	<p>1st Option: Pull Option: A Arch S Square H Straight <i>Pulls are PR6 Silver, color not specified.</i> I Integral</p> <p>_____ .</p>	<p>2nd Option: Paint: See inside front cover for finishes.</p> <p>P _____ .</p>	<p>3rd Option: Lock: L Lock X Omit Lock Core (Deduct \$18 per lock) <i>Lock is EL Silver, color not specified.</i></p> <p>_____ .</p>	<p>4th Option: Foot Paint Color (if applicable): C S See inside front cover for finishes. Stride feet are limited to PR6 Silver.</p> <p>P _____</p>
--	--	---	---	---

Examples: YPWTBX421224LA.P02.L YPWTF421224LS.P7B.X.PR6
YPWTAKP.P02 YPWTASHELF24.PR6

Align™ Metal Storage

For specification information see pages 23 and 33.

12"W Wardrobe / Single Lockers

Laminate Fronts with Plinth Base or Footed

GSA SIN 711-3

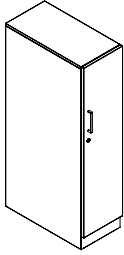

Width	Model	P1 Core Paint			P2 Select Paint		
		L1	L2	L3	L1	L2	L3
42½" H Wardrobe / Locker — 12"W – Metal Case/Laminate Front/Recessed Base							
18"D Hinges on Left	YPWTBX421218LL	\$ 1513	\$ 1580	\$ 1648	\$ 1594	\$ 1661	\$ 1729
18"D Hinges on Right	YPWTBX421218RL	\$ 1513	\$ 1580	\$ 1648	\$ 1594	\$ 1661	\$ 1729
24"D Hinges on Left	YPWTBX421224LL	\$ 1599	\$ 1670	\$ 1741	\$ 1684	\$ 1755	\$ 1826
24"D Hinges on Right (shown)	YPWTBX421224RL	\$ 1599	\$ 1670	\$ 1741	\$ 1684	\$ 1755	\$ 1826
50" H Wardrobe / Locker — 12"W – Metal Case/Laminate Front/Recessed Base							
18"D Hinges on Left	YPWTBX501218LL	\$ 1591	\$ 1661	\$ 1731	\$ 1675	\$ 1745	\$ 1815
18"D Hinges on Right	YPWTBX501218RL	\$ 1591	\$ 1661	\$ 1731	\$ 1675	\$ 1745	\$ 1815
24"D Hinges on Left	YPWTBX501224LL	\$ 1681	\$ 1755	\$ 1829	\$ 1770	\$ 1844	\$ 1918
24"D Hinges on Right	YPWTBX501224RL	\$ 1681	\$ 1755	\$ 1829	\$ 1770	\$ 1844	\$ 1918

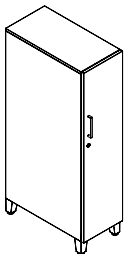

Width	Create Model — Add "T" or "Z": "TF" Terrace Feet, or "ZF" Stride Feet +\$63 extra	P1 Core Paint			P2 Select Paint		
		L1	L2	L3	L1	L2	L3
42½" H Wardrobe / Locker — 12"W – Metal Case/Laminate Front/Recessed Base							
18"D Hinges on Left	YPWT <input type="checkbox"/> F421218LL	\$ 1653	\$ 1720	\$ 1788	\$ 1734	\$ 1801	\$ 1869
18"D Hinges on Right	YPWT <input type="checkbox"/> F421218RL	\$ 1653	\$ 1720	\$ 1788	\$ 1734	\$ 1801	\$ 1869
24"D Hinges on Left	YPWT <input type="checkbox"/> F421224LL	\$ 1762	\$ 1833	\$ 1904	\$ 1847	\$ 1918	\$ 1989
24"D Hinges on Right (shown)	YPWT <input type="checkbox"/> F421224RL	\$ 1762	\$ 1833	\$ 1904	\$ 1847	\$ 1918	\$ 1989
50" H Wardrobe / Locker — 12"W – Metal Case/Laminate Front/Recessed Base							
18"D Hinges on Left	YPWT <input type="checkbox"/> F501218LL	\$ 1732	\$ 1802	\$ 1872	\$ 1816	\$ 1886	\$ 1956
18"D Hinges on Right	YPWT <input type="checkbox"/> F501218RL	\$ 1732	\$ 1802	\$ 1872	\$ 1816	\$ 1886	\$ 1956
24"D Hinges on Left	YPWT <input type="checkbox"/> F501224LL	\$ 1847	\$ 1921	\$ 1995	\$ 1936	\$ 2010	\$ 2084
24"D Hinges on Right	YPWT <input type="checkbox"/> F501224RL	\$ 1847	\$ 1921	\$ 1995	\$ 1936	\$ 2010	\$ 2084

<p>How to specify — Select the Model Number from above.</p> <p>Y P W </p>	<p>1st Option: Pull Option: A Arch S Square H Straight Pulls are PR6 Silver, color not specified.</p>	<p>2nd Option: Paint: See inside front cover for finishes.</p>	<p>3rd Option: Lock: L Lock X Omit Lock Core (Deduct \$18 per lock) Lock is EL Silver, color not specified.</p>	<p>4th Option: Foot Paint Color (if applicable): C S See inside front cover for finishes. Stride feet are limited to PR6 Silver.</p>	<p>5th Option: Laminate: See inside front cover for finishes.</p>	<p>6th Option: Edge: Edge color is pre-determined by laminate selection.</p>
	<p>Y P W </p>	<p>. P </p>	<p>. X </p>	<p>. C S </p>	<p> </p>	<p> </p>

Examples: YPWTBX421218LLA.P02.L YPWTF421218LLS.PQ8.X.PR6.LM14EW

Align™ Metal Storage

12"W Double Lockers

For specification information see pages 23 and 33.

Metal Fronts with Plinth Base or Footed

GSA SIN 711-3

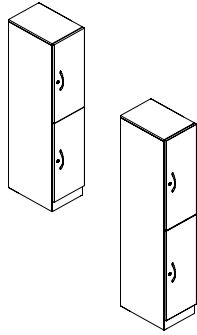

Description	Create Model — Add "X" or "K": "BX" Recessed Base, or "BK" Flush Kickplate	Core Paint		Select Paint
		P1 List Price	P2 List Price	P2 List Price
57"H Double Locker — 12"W — Metal Case/Metal Fronts				
18"D Hinges on Left	YPDWB □ 571218LM	\$ 1326		\$ 1405
18"D Hinges on Right (shown)	YPDWB □ 571218RM	\$ 1326		\$ 1405
24"D Hinges on Left	YPDWB □ 571224LM	\$ 1433		\$ 1518
24"D Hinges on Right	YPDWB □ 571224RM	\$ 1433		\$ 1518
65"H Double Locker — 12"W — Metal Case/Metal Fronts				
18"D Hinges on Left	YPDWB □ 651218LM	\$ 1382		\$ 1464
18"D Hinges on Right (shown)	YPDWB □ 651218RM	\$ 1382		\$ 1464
24"D Hinges on Left	YPDWB □ 651224LM	\$ 1489		\$ 1578
24"D Hinges on Right	YPDWB □ 651224RM	\$ 1489		\$ 1578

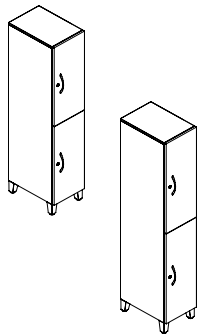

Description	Create Model — Add "T" or "Z": "TF" Terrace Feet, or "ZF" Stride Feet +\$63 extra	Core Paint		Select Paint
		P1 List Price	P2 List Price	P2 List Price
57"H Double Locker — 12"W — Metal Case/Metal Fronts				
18"D Hinges on Left	YPDW □ F571218LM	\$ 1444		\$ 1523
18"D Hinges on Right (shown)	YPDW □ F571218RM	\$ 1444		\$ 1523
24"D Hinges on Left	YPDW □ F571224LM	\$ 1551		\$ 1636
24"D Hinges on Right	YPDW □ F571224RM	\$ 1551		\$ 1636
65"H Double Locker — 12"W — Metal Case/Metal Fronts				
18"D Hinges on Left	YPDW □ F651218LM	\$ 1500		\$ 1582
18"D Hinges on Right (shown)	YPDW □ F651218RM	\$ 1500		\$ 1582
24"D Hinges on Left	YPDW □ F651224LM	\$ 1607		\$ 1696
24"D Hinges on Right	YPDW □ F651224RM	\$ 1607		\$ 1696

<p>How to specify — Select the Model Number from above.</p>	<p>1st Option: Pull Option: A Arch S Square H Straight <i>Pulls are PR6 Silver, color not specified.</i> I Integral</p>	<p>2nd Option: Paint: See inside front cover for finishes.</p>	<p>3rd Option: Lock: L Lock X Omit Lock Core (Deduct \$18 per lock) <i>Lock is EL Silver, color not specified.</i></p>	<p>4th Option: Foot Color (if applicable): C S See inside front cover for finishes. Stride feet are limited to PR6 Silver.</p>

Examples: YPDWBX571218RMS.P02.L YPDWTF651218RMS.PQ8.X.PR6

Align™ Metal Storage

12"W Double Lockers

For specification information see pages 23 and 33.

Laminate Fronts with Plinth Base or Footed

GSA SIN 711-3

Width	Model	P1 Core Paint			P2 Select Paint		
		L1	L2	L3	L1	L2	L3
57"H Double Locker — 12"W – Metal Case/Laminate Fronts							
18"D Hinges on Left	YPDWBX571218LL	\$ 1512	\$ 1587	\$ 1663	\$ 1591	\$ 1666	\$ 1742
18"D Hinges on Right (shown)	YPDWBX571218RL	\$ 1512	\$ 1587	\$ 1663	\$ 1591	\$ 1666	\$ 1742
24"D Hinges on Left	YPDWBX571224LL	\$ 1634	\$ 1715	\$ 1797	\$ 1719	\$ 1800	\$ 1882
24"D Hinges on Right	YPDWBX571224RL	\$ 1634	\$ 1715	\$ 1797	\$ 1719	\$ 1800	\$ 1882
65"H Double Locker — 12"W – Metal Case/Laminate Fronts							
18"D Hinges on Left	YPDWBX651218LL	\$ 1617	\$ 1697	\$ 1778	\$ 1699	\$ 1779	\$ 1860
18"D Hinges on Right (shown)	YPDWBX651218RL	\$ 1617	\$ 1697	\$ 1778	\$ 1699	\$ 1779	\$ 1860
24"D Hinges on Left	YPDWBX651224LL	\$ 1742	\$ 1829	\$ 1916	\$ 1831	\$ 1918	\$ 2005
24"D Hinges on Right	YPDWBX651224RL	\$ 1742	\$ 1829	\$ 1916	\$ 1831	\$ 1918	\$ 2005

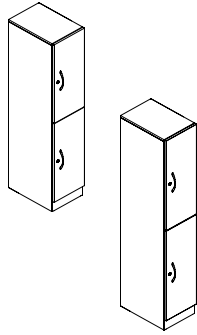

Width	Create Model — Add "T" or "Z": "TF" Terrace Feet, or "ZF" Stride Feet +\$63 extra	P1 Core Paint			P2 Select Paint		
		L1	L2	L3	L1	L2	L3
57"H Double Locker — 12"W – Metal Case/Laminate Fronts							
18"D Hinges on Left	YPDW □ F571218LL	\$ 1646	\$ 1721	\$ 1797	\$ 1725	\$ 1800	\$ 1876
18"D Hinges on Right (shown)	YPDW □ F571218RL	\$ 1646	\$ 1721	\$ 1797	\$ 1725	\$ 1800	\$ 1876
24"D Hinges on Left	YPDW □ F571224LL	\$ 1768	\$ 1849	\$ 1931	\$ 1853	\$ 1934	\$ 2016
24"D Hinges on Right	YPDW □ F571224RL	\$ 1768	\$ 1849	\$ 1931	\$ 1853	\$ 1934	\$ 2016
65"H Double Locker — 12"W – Metal Case/Laminate Fronts							
18"D Hinges on Left	YPDW □ F651218LL	\$ 1756	\$ 1836	\$ 1917	\$ 1838	\$ 1918	\$ 2002
18"D Hinges on Right (shown)	YPDW □ F651218RL	\$ 1756	\$ 1836	\$ 1917	\$ 1838	\$ 1918	\$ 2002
24"D Hinges on Left	YPDW □ F651224LL	\$ 1881	\$ 1968	\$ 2055	\$ 1970	\$ 2057	\$ 2144
24"D Hinges on Right	YPDW □ F651224RL	\$ 1881	\$ 1968	\$ 2055	\$ 1970	\$ 2057	\$ 2144

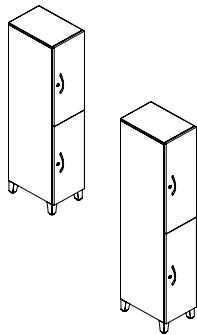

<p>How to specify — Select the Model Number from above.</p>	<p>1st Option: Pull Option: A Arch S Square H Straight <i>Pulls are PR6 Silver, color not specified.</i></p>	<p>2nd Option: Paint: See inside front cover for finishes.</p>	<p>3rd Option: Lock: L Lock X Omit Lock Core (Deduct \$18 per lock) <i>Lock is EL Silver, color not specified.</i></p>	<p>4th Option: Foot Color (if applicable): C S See inside front cover for finishes. Stride feet are limited to PR6 Silver.</p>	<p>5th Option: Laminate: See inside front cover for finishes.</p>	<p>6th Option: Edge: Edge color is pre-determined by laminate selection.</p>
<p>_____</p> <p>_____</p>	<p>_____ .</p> <p>P _____ .</p>	<p>_____ .</p> <p>_____ .</p>	<p>_____ .</p> <p>_____ .</p>	<p>P _____ .</p> <p>_____ .</p>	<p>_____</p> <p>_____</p>	<p>_____</p> <p>_____</p>

Examples: YPDWBX571218RLS.P02.L YPDWTF651218RLS.PQ8.X.PR6.LM14EW

Align™ Metal Storage

24"W Quad Lockers

For specification information see pages 23 and 33.

Metal Fronts with Plinth Base or Footed

GSA SIN 711-3

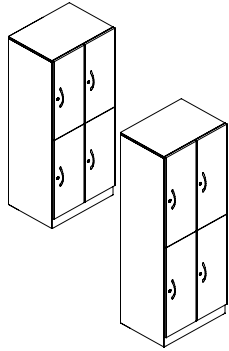

Description	Create Model — Add "X" or "K": "BX" Recessed Base, or "BK" Flush Kickplate	Core Paint		Select Paint
		P1 List Price	P2 List Price	P2 List Price
57"H Quad Locker — 24"W — Metal Case/Metal Fronts				
18"D Hinges on Left	YPQWB □ 572418LM	\$ 2071		\$ 2195
18"D Hinges on Right (shown)	YPQWB □ 572418RM	\$ 2071		\$ 2195
24"D Hinges on Left	YPQWB □ 572424LM	\$ 2220		\$ 2353
24"D Hinges on Right	YPQWB □ 572424RM	\$ 2220		\$ 2353
65"H Quad Locker — 24"W — Metal Case/Metal Fronts				
18"D Hinges on Left	YPQWB □ 652418LM	\$ 2140		\$ 2268
18"D Hinges on Right (shown)	YPQWB □ 652418RM	\$ 2140		\$ 2268
24"D Hinges on Left	YPQWB □ 652424LM	\$ 2289		\$ 2426
24"D Hinges on Right	YPQWB □ 652424RM	\$ 2289		\$ 2426

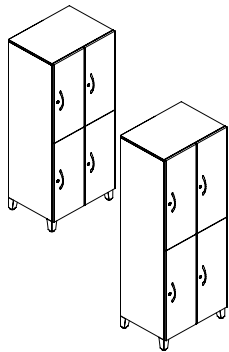

Description	Create Model — Add "T" or "Z": "TF" Terrace Feet, or "ZF" Stride Feet +\$63 extra	Core Paint		Select Paint
		P1 List Price	P2 List Price	P2 List Price
57"H Quad Locker — 24"W — Metal Case/Metal Fronts				
18"D Hinges on Left	YPQW □ F572418LM	\$ 2183		\$ 2307
18"D Hinges on Right (shown)	YPQW □ F572418RM	\$ 2183		\$ 2307
24"D Hinges on Left	YPQW □ F572424LM	\$ 2332		\$ 2465
24"D Hinges on Right	YPQW □ F572424RM	\$ 2332		\$ 2465
65"H Quad Locker — 24"W — Metal Case/Metal Fronts				
18"D Hinges on Left	YPQW □ F652418LM	\$ 2252		\$ 2380
18"D Hinges on Right (shown)	YPQW □ F652418RM	\$ 2252		\$ 2380
24"D Hinges on Left	YPQW □ F652424LM	\$ 2401		\$ 2538
24"D Hinges on Right	YPQW □ F652424RM	\$ 2401		\$ 2538

How to specify — Select the Model Number from above.	1st Option: Pull Option: A Arch S Square H Straight <i>Pulls are PR6 Silver, color not specified.</i> I Integral	2nd Option: Paint: See inside front cover for finishes.	3rd Option: Lock: L Lock X Omit Lock Core (Deduct \$18 per lock) <i>Lock is EL Silver, color not specified.</i>	4th Option: Foot Color (if applicable): C S See inside front cover for finishes. Stride feet are limited to PR6 Silver.
	_____ _____	_____ .	P _____ .	_____ .

Examples: YPQWBX572418RMS.P02.L YPQWTF652418RMS.PQ8.X.PR6

Align™ Metal Storage

24"W Quad Lockers

For specification information see pages 23 and 33.

Laminate Fronts with Plinth Base or Footed

GSA SIN 711-3

Width	Model	P1 Core Paint			P2 Select Paint		
		L1	L2	L3	L1	L2	L3
57"H Quad Locker — 24"W – Metal Case/Laminate Fronts							
18"D Hinges on Left	YPQWBX572418LL	\$ 2361	\$ 2479	\$ 2597	\$ 2485	\$ 2603	\$ 2721
18"D Hinges on Right (shown)	YPQWBX572418RL	\$ 2361	\$ 2479	\$ 2597	\$ 2485	\$ 2603	\$ 2721
24"D Hinges on Left	YPQWBX572424LL	\$ 2531	\$ 2657	\$ 2784	\$ 2664	\$ 2790	\$ 2917
24"D Hinges on Right	YPQWBX572424RL	\$ 2531	\$ 2657	\$ 2784	\$ 2664	\$ 2790	\$ 2917
65"H Quad Locker — 24"W – Metal Case/Laminate Fronts							
18"D Hinges on Left	YPQWBX652418LL	\$ 2504	\$ 2629	\$ 2754	\$ 2632	\$ 2757	\$ 2882
18"D Hinges on Right (shown)	YPQWBX652418RL	\$ 2504	\$ 2629	\$ 2754	\$ 2632	\$ 2757	\$ 2882
24"D Hinges on Left	YPQWBX652424LL	\$ 2679	\$ 2812	\$ 2946	\$ 2816	\$ 2949	\$ 3083
24"D Hinges on Right	YPQWBX652424RL	\$ 2679	\$ 2812	\$ 2946	\$ 2816	\$ 2949	\$ 3083

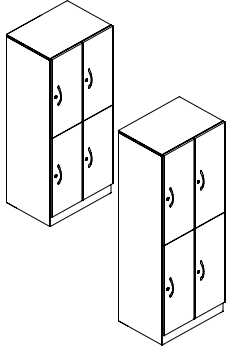

Width	Create Model — Add "T" or "Z": "TF" Terrace Feet, or "ZF" Stride Feet +\$63 extra	P1 Core Paint			P2 Select Paint		
		L1	L2	L3	L1	L2	L3
57"H Quad Locker — 24"W – Metal Case/Laminate Fronts							
18"D Hinges on Left	YPQW □ F572418LL	\$ 2489	\$ 2607	\$ 2725	\$ 2613	\$ 2731	\$ 2849
18"D Hinges on Right (shown)	YPQW □ F572418RL	\$ 2489	\$ 2607	\$ 2725	\$ 2613	\$ 2731	\$ 2849
24"D Hinges on Left	YPQW □ F572424LL	\$ 2659	\$ 2785	\$ 2912	\$ 2792	\$ 2918	\$ 3045
24"D Hinges on Right	YPQW □ F572424RL	\$ 2659	\$ 2785	\$ 2912	\$ 2792	\$ 2918	\$ 3045
65"H Quad Locker — 24"W – Metal Case/Laminate Fronts							
18"D Hinges on Left	YPQW □ F652418LL	\$ 2635	\$ 2760	\$ 2885	\$ 2763	\$ 2888	\$ 3013
18"D Hinges on Right (shown)	YPQW □ F652418RL	\$ 2635	\$ 2760	\$ 2885	\$ 2763	\$ 2888	\$ 3013
24"D Hinges on Left	YPQW □ F652424LL	\$ 2810	\$ 2943	\$ 3077	\$ 2947	\$ 3080	\$ 3214
24"D Hinges on Right	YPQW □ F652424RL	\$ 2810	\$ 2943	\$ 3077	\$ 2947	\$ 3080	\$ 3214

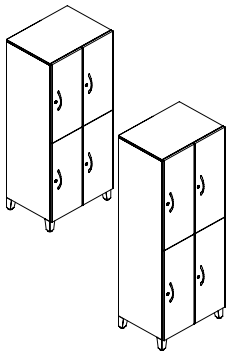

<p>How to specify — Select the Model Number from above.</p>	<p>1st Option: Pull Option: A Arch S Square H Straight Pulls are PR6 Silver, color not specified.</p>	<p>2nd Option: Paint: See inside front cover for finishes.</p>	<p>3rd Option: Lock: L Lock X Omit Lock Core (Deduct \$18 per lock) Lock is EL Silver, color not specified.</p>	<p>4th Option: Foot Color (if applicable): C S See inside front cover for finishes. Stride feet are limited to PR6 Silver.</p>	<p>5th Option: Laminate: See inside front cover for finishes.</p>	<p>6th Option: Edge: Edge color is pre-determined by laminate selection.</p>
<p>_____</p> <p>_____</p>	<p>_____ .</p> <p>P _____ .</p>	<p>_____ .</p> <p>_____ .</p>	<p>_____ .</p> <p>P _____ .</p>	<p>_____ .</p> <p>_____ .</p>	<p>_____ .</p> <p>_____ .</p>	<p>_____ .</p> <p>_____ .</p>

Examples: YPQWBX572418RLS.P02.L YPQWTF652418RLS.PQ8.X.PR6.LM14EW

Align™ Metal Storage

24"W Cubby Lockers

For specification information see pages 23 and 33.

Metal Fronts with Plinth Base or Footed

GSA SIN 711-3

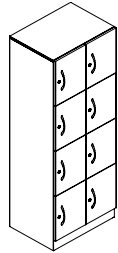
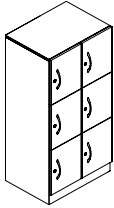
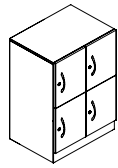

Description	Create Model — Add "X" or "K": "BX" Recessed Base, or "BK" Flush Kickplate	Core Paint		Select Paint
		P1 List Price	P2 List Price	P2 List Price
35"H Cubby Locker — 24"W — Metal Case/Metal Fronts				
18"D Hinges on Left	YPLWB □ 352418LM	\$ 2012		\$ 2132
18"D Hinges on Right (shown)	YPLWB □ 352418RM	\$ 2012		\$ 2132
50"H Cubby Locker — 24"W — Metal Case/Metal Fronts				
18"D Hinges on Left	YPLWB □ 502418LM	\$ 2566		\$ 2719
18"D Hinges on Right (shown)	YPLWB □ 502418RM	\$ 2566		\$ 2719
65"H Cubby Locker — 24"W — Metal Case/Metal Fronts				
18"D Hinges on Left	YPLWB □ 652418LM	\$ 2916		\$ 3090
18"D Hinges on Right (shown)	YPLWB □ 652418RM	\$ 2916		\$ 3090

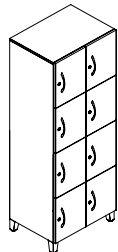
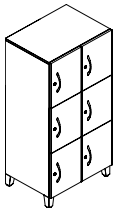
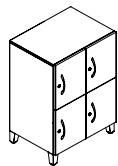

Description	Create Model — Add "T" or "Z": "TF" Terrace Feet, or "ZF" Stride Feet +\$63 extra	Core Paint		Select Paint
		P1 List Price	P2 List Price	P2 List Price
35"H Cubby Locker — 24"W — Metal Case/Metal Fronts				
18"D Hinges on Left	YPLW □ F352418LM	\$ 2141		\$ 2261
18"D Hinges on Right (shown)	YPLW □ F352418RM	\$ 2141		\$ 2261
50"H Cubby Locker — 24"W — Metal Case/Metal Fronts				
18"D Hinges on Left	YPLW □ F502418LM	\$ 2695		\$ 2848
18"D Hinges on Right (shown)	YPLW □ F502418RM	\$ 2695		\$ 2848
65"H Cubby Locker — 24"W — Metal Case/Metal Fronts				
18"D Hinges on Left	YPLW □ F652418LM	\$ 3046		\$ 3220
18"D Hinges on Right (shown)	YPLW □ F652418RM	\$ 3046		\$ 3220

How to specify —
Select the Model Number from above.

1st Option:

Pull Option:

A Arch
S Square
H Straight
Pulls are **PR6** Silver, color not specified.

I Integral

2nd Option:

Paint:

See inside front cover for finishes.

3rd Option:

Lock:

L Lock
X Omit Lock Core (Deduct \$18 per lock)
Lock is **EL** Silver, color not specified.

4th Option:

Foot Color
(if applicable):

C S
See inside front cover for finishes. Stride feet are limited to **PR6** Silver.

Examples: YPLWBX502418RMS.P02.L YPLWTF652418RMS.PQ8.X.PR6

Align™ Metal Storage

24"W Cubby Lockers

For specification information see pages 23 and 33.

Laminate Fronts with Plinth Base or Footed

GSA SIN 711-3

Width	Model	P1 Core Paint			P2 Select Paint		
		L1	L2	L3	L1	L2	L3
35"H Cubby Locker — 24"W – Metal Case/Laminate Fronts							
18"D Hinges on Left	YPLWBX352418LL	\$ 2273	\$ 2386	\$ 2500	\$ 2393	\$ 2506	\$ 2620
18"D Hinges on Right (shown)	YPLWBX352418RL	\$ 2273	\$ 2386	\$ 2500	\$ 2393	\$ 2506	\$ 2620
50"H Cubby Locker — 24"W – Metal Case/Laminate Fronts							
18"D Hinges on Left	YPLWBX502418LL	\$ 2899	\$ 3043	\$ 3188	\$ 3052	\$ 3196	\$ 3341
18"D Hinges on Right (shown)	YPLWBX502418RL	\$ 2899	\$ 3043	\$ 3188	\$ 3052	\$ 3196	\$ 3341
65"H Cubby Locker — 24"W – Metal Case/Laminate Fronts							
18"D Hinges on Left	YPLWBX652418LL	\$ 3412	\$ 3582	\$ 3753	\$ 3586	\$ 3756	\$ 3927
18"D Hinges on Right (shown)	YPLWBX652418RL	\$ 3412	\$ 3582	\$ 3753	\$ 3586	\$ 3756	\$ 3927

Width	Create Model — Add "T" or "Z": "TF" Terrace Feet, or "ZF" Stride Feet +\$63 extra	P1 Core Paint			P2 Select Paint		
		L1	L2	L3	L1	L2	L3
35"H Cubby Locker — 24"W – Metal Case/Laminate Fronts							
18"D Hinges on Left	YPLW □ F352418LL	\$ 2419	\$ 2532	\$ 2646	\$ 2539	\$ 2652	\$ 2766
18"D Hinges on Right (shown)	YPLW □ F352418RL	\$ 2419	\$ 2532	\$ 2646	\$ 2539	\$ 2652	\$ 2766
50"H Cubby Locker — 24"W – Metal Case/Laminate Fronts							
18"D Hinges on Left	YPLW □ F502418LL	\$ 3045	\$ 3189	\$ 3334	\$ 3198	\$ 3342	\$ 3487
18"D Hinges on Right (shown)	YPLW □ F502418RL	\$ 3045	\$ 3189	\$ 3334	\$ 3198	\$ 3342	\$ 3487
65"H Cubby Locker — 24"W – Metal Case/Laminate Fronts							
18"D Hinges on Left	YPLW □ F652418LL	\$ 3564	\$ 3734	\$ 3905	\$ 3738	\$ 3908	\$ 4079
18"D Hinges on Right (shown)	YPLW □ F652418RL	\$ 3564	\$ 3734	\$ 3905	\$ 3738	\$ 3908	\$ 4079

How to specify — Select the Model Number from above.	1st Option: Pull Option: A Arch S Square H Straight Pulls are PR6 Silver, color not specified.	2nd Option: Paint: See inside front cover for finishes.	3rd Option: Lock: L Lock X Omit Lock Core (Deduct \$18 per lock) Lock is EL Silver, color not specified.	4th Option: Foot Color (if applicable): C S See inside front cover for finishes. Stride feet are limited to PR6 Silver.	5th Option: Laminate: See inside front cover for finishes.	6th Option: Edge: Edge color is pre-determined by laminate selection.
_____	_____	P _____	_____	P _____	_____	_____

Examples: YPLWBX502418RLS.P02.L YPLWTF652418RLS.PQ8.X.PR6.LM14EW

Align™ Metal Storage

Laminate Tops for Lockers

For specification information see page 33.

GSA SIN 711-1



Description	Model	Width Min - Max	Depth Min - Max	9120 Min - Max	List Price		
					L1	L2	L3
18"D Laminate Tops — Flat Edge for Lockers (1¼" Thick)							
24½"W (2 - 12"W)*	9120R3018	241W - 300W	121D - 180D	241W x 180D	\$ 312	\$ 328	\$ 344
36½"W (3 - 12"W)*	9120R4218	361W - 420W	121D - 180D	362W x 180D	\$ 376	\$ 395	\$ 414
48½"W (2 - 24"W)*	9120R6018	481W - 600W	121D - 180D	481W x 180D	\$ 539	\$ 568	\$ 592
48½"W (4 - 12"W)*	9120R6018	481W - 600W	121D - 180D	483W x 180D	\$ 539	\$ 568	\$ 592
60½"W (5 - 12"W)*	9120R7218	601W - 720W	121D - 180D	604W x 180D	\$ 650	\$ 683	\$ 714
72½"W (6 - 12"W)*	9120R8418	721W - 840W	121D - 180D	725W x 180D	\$ 851	\$ 893	\$ 936
72½"W (3 - 24"W)*	9120R8418	721W - 840W	121D - 180D	722W x 180D	\$ 851	\$ 893	\$ 936
84½"W (7 - 12"W)*	9120R9618	841W - 960W	121D - 180D	846W x 180D	\$ 880	\$ 924	\$ 967
96½"W (4 - 24"W)*	9120R10818	961W - 1080W	121D - 180D	963W x 180D	\$ 1006	\$ 1055	\$ 1105

*Examples in parenthesis above are quantity of units and width; additional 1/8" required to span between each unit.

36"D Laminate Tops — Flat Edge for 18"D Back-to-Back Lockers (1¼" Thick)

48½"W (2 - 24"W)*	9120R6036	481W - 600W	301D - 360D	481W x 360D	\$ 870	\$ 913	\$ 956
48½"W (4 - 12"W)*	9120R6036	481W - 600W	301D - 360D	483W x 360D	\$ 870	\$ 913	\$ 956
60½"W (5 - 12"W)*	9120R7236	601W - 720W	301D - 360D	604W x 360D	\$ 1025	\$ 1076	\$ 1126
72½"W (6 - 12"W)*	9120R8436	721W - 840W	301D - 360D	725W x 360D	\$ 1242	\$ 1303	\$ 1365
72½"W (3 - 24"W)*	9120R8436	721W - 840W	301D - 360D	722W x 360D	\$ 1242	\$ 1303	\$ 1365
84½"W (7 - 12"W)*	9120R9636	841W - 960W	301D - 360D	846W x 360D	\$ 1271	\$ 1334	\$ 1396
96½"W (4 - 24"W)*	9120R10836	961W - 1080W	301D - 360D	963W x 360D	\$ 1410	\$ 1479	\$ 1550

*Examples in parenthesis above are quantity of units and width; additional 1/8" required to span between each unit.

<p>How to specify — Select the Model Number from above.</p> <p>9120R</p> <p> </p>	<p>1st Option: Grommet: GO None</p> <p>GO .</p>	<p>2nd Option: Laminate: See inside front cover for finishes.</p> <p> </p>	<p>3rd Option: Edge: See inside front cover for finishes.</p> <p> </p>	<p>4th Option: 9120 Exact Size: Specify the EXACT Width and EXACT Depth you require. Width and depth is specified in ½" increments which is denoted as a single digit following the whole number dimension at the end of the model number string.</p> <p>½" = 1 ¾" = 5 ⅔" = 2 ⅝" = 6 ⅞" = 3 ⅞" = 7 1" = 4 no extra increment = 0</p> <p>For example, when ordering a worksurface 24½"W x 18"D, specification should be 241Wx180D.</p> <p> </p>
--	--	---	---	--

Examples: 9120R3018.GO.LT3B.E4.241WX180D

Essentials™ Metal Storage

Storage Overview	10
Pull Option Matrix.....	11
Essentials Statement of Line	13
<i>Working With Essentials Metal Storage —</i>	
<i>Specification Information</i>	
Working with Essentials Personal Storage	60-61
Working with Essentials Pedestals	62-63
Working with Essentials Personal Files.....	64
Working with Essentials Towers.....	65
Working with Essentials Shared Storage.....	66
Working with Essentials Laterals.....	67
Working with Essentials Combination Files	67
Working with Essentials Cabinets	68
Working with Essentials Bookcases	68
Working with Essentials Tops for Metal Storage.....	69
<i>Essentials Metal Case Personal Storage — Pricing Information</i>	
Support and Mobile Pedestals	70-72
Accessories and Pedestal Tops for Essentials	73
Personal Files.....	74
Personal Towers	75
<i>Essentials Metal Case Shared Storage — Pricing Information</i>	
Lateral Files and Accessories	76
Combination Files	77
Storage Cabinets.....	77
Bookcases	77
Metal Storage Laminate and Veneer Tops	78

Essentials Pedestals

- File drawers can accommodate front-to-back filing on all models, and side-to-side filing on 22 $\frac{1}{2}$ "D and 28 $\frac{1}{2}$ "D models.
- Support pedestals of a maximum depth, relative to the worksurface depth, result in one panel receptacle position being inaccessible.
- 22 $\frac{1}{2}$ "D units cannot be used with 24"D Concensys® Freestanding.
- 28 $\frac{1}{2}$ "D units cannot be used with any 30"D Concensys Freestanding or any 24"D panel-hung worksurface.
- For locking specifications, see pages 180-182.
- Leveling capacity is 2" on 28"H pedestals.

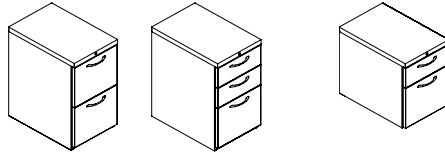

Support pedestals can support one end of a panel-attached worksurface, in lieu of other worksurface supports by using a 28"H support pedestal but cannot be used to support freestanding desking without an end panel.

Suspended pedestals mount to the underside of the worksurface using keyhole slots in top of pedestals. Do not mount suspended pedestals on bridges or peninsulas. Always mount suspended pedestals at end of worksurfaces.

When using suspended units on systems, a return panel should extend 18" minimum beyond leading edge of worksurface on which unit(s) is mounted.

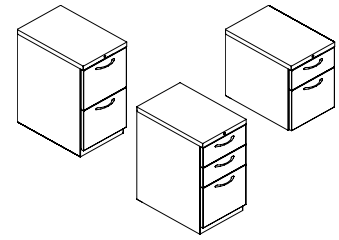

Mobile Pedestals can be used to provide flexible storage. The nominal height of a mobile pedestal is equal to that of a freestanding pedestal of equivalent design. There is no need to add extra height for the casters.

Both 26 $\frac{1}{2}$ "H and 28"H mobile pedestals can be nested under worksurfaces mounted at 29 $\frac{1}{2}$ "H. If using 28"H Essentials mobile pedestals underneath a panel mounted worksurface on Stride®, Terrace®, or Optimize™ the panel glides will need to be extended a minimum of $\frac{3}{4}$ " to allow for the mobile pedestals to slide underneath the worksurface.

Mobile pedestals cannot be leveled. Take this into consideration when planning offices which may have uneven floors.

Pedestal Compatibility with Cadence® Desking and Systems Worksurfaces

Pedestal Depth	Freestanding		Systems Panel-hung Worksurfaces	
	24" Deep	30" Deep	24" Deep	30" Deep
18"	Yes	Yes	Yes	Yes
19 $\frac{1}{2}$ "	Yes*	Yes	Yes*	Yes
22 $\frac{1}{2}$ "		Yes	Yes*	Yes
28 $\frac{1}{2}$ "				Yes*

*Wire management grommet is blocked in these applications.

Note: Pedestal placement may affect access to receptacles in base pathway.

Essentials storage pedestals are available in 5 styles:



Worksurface height mobile and worksurface supporting pedestals have a taller base plate, resulting in a taller overall cabinet height. Consideration must be made to ensure that units align visually with each other and with selected Essentials lateral files. The accompanying chart will help you select the correct pedestal for your application.

Essentials Pedestal Model begins with	Style	Overall Height	Base Height	Spacer required below worksurface	Units align with these Essentials Lateral Models begin with
xx11	Seat height	22 $\frac{1}{2}$ "	2"	N/A	N/A
xx14	Suspended	19 $\frac{1}{2}$ "	N/A	N/A	N/A
xx18, xx38	Worksurface height mobile	28" **	3 $\frac{1}{4}$ "	N/A	ELF8 (2-high only)
xx19, xx39	Worksurface supporting*	28"	3 $\frac{1}{4}$ "	No	ELF8 (2-high only)

*Units will support conventional 29 $\frac{1}{2}$ " high worksurfaces.

**When using 28"H Essentials mobile pedestals underneath a panel mounted worksurface on Stride or Terrace, the panel glides need to be extended a minimum of $\frac{3}{4}$ " to allow for the mobile pedestals to slide underneath the worksurface.

Essentials Personal File

Lateral File Drawer

Lateral File Drawer contains dual-side locking.

File and Box Drawers

File and box drawers contain single-side locking.

Door with Shelf

Door (non-locking) with Shelf contains one shelf that is adjustable in 2" increments.

Hanging Frames

Side-to-side filing comes standard in lateral drawer.

Side Knockouts

Files have knockouts on each side to allow easy ganging of freestanding units to inhibit tipping.

Inset Drawer Design

Drawers are inset inside the case. Base plate is flush with drawer fronts.

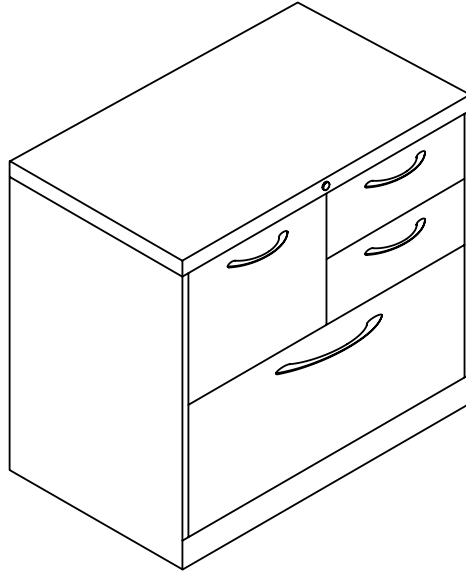

GSA Reference Page

Core Removable Locks

Core removable lock feature allows key numbers to be easily changed in the field. It also facilitates installation.

Omit Lock Core

Files can be shipped with lock cores removed; cores can then be installed after files are placed. Personal files and lateral files can be keyed alike with pedestals and overhead cabinets.

Four Pull Styles

Choice of four pull styles, also available on pedestals and laterals, allows for total design coordination on projects.

Four Hex-head Leveling Glides

Leveling glides can be adjusted from outside or inside the case. Because of the hex-head design of the stem; leveling can be done even when the personal file is fully loaded. Range is 1".

Suspension

Telescoping ball-bearing slides.

Essentials Personal Towers

Locking

One lock secures all drawers and separate locks on each door.

File and Box Drawers

File and box drawers contain single-side locking.

Open Shelves

provide visibility for personal items and easy access to binders or resource books. Two adjustable shelves on 65"H and one adjustable shelf on 50"H.

European Hinges

Wardrobe and cabinet door both contain European-style hinged door.

Full Front Drawer Design

Door/drawer fronts are square and extend fully across the case. Base plate is recessed.

Worksurface Bracket

An Essentials tower to worksurface bracket can be ordered separately and mounted to side access models to support a worksurface.

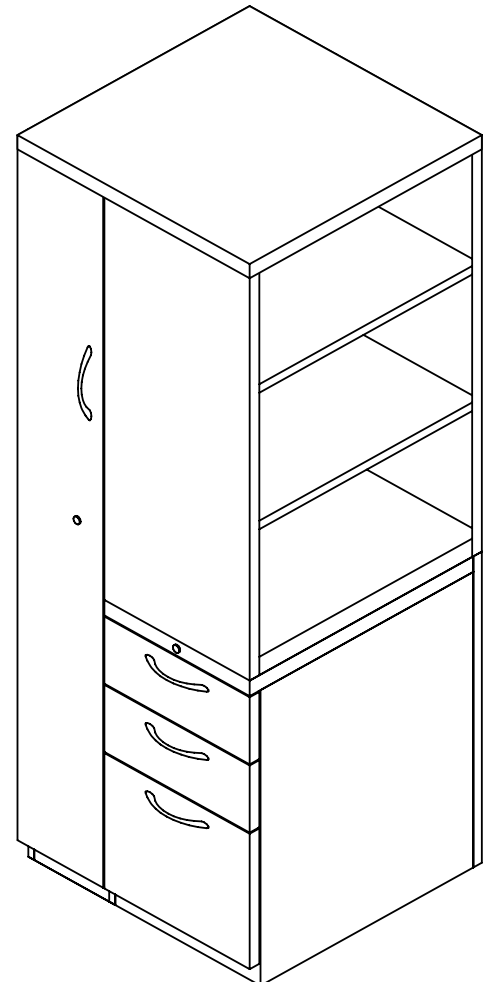
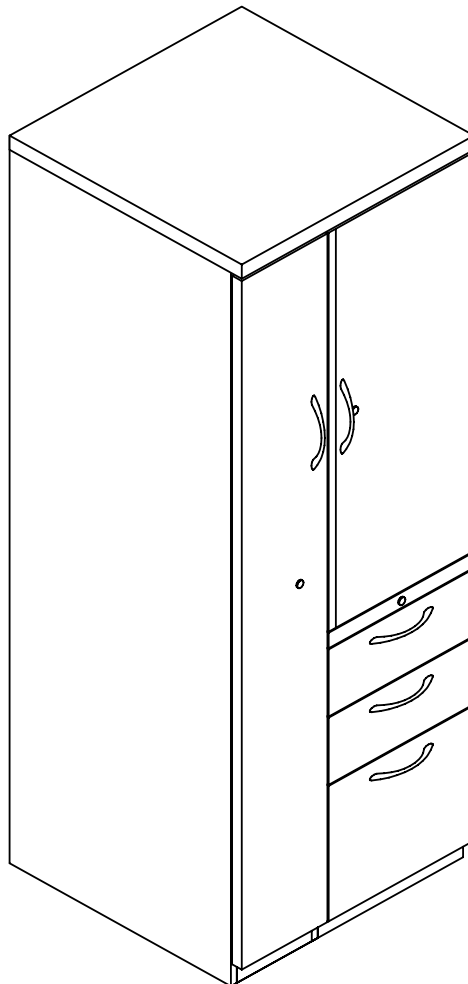

Essentials™ Pedestals

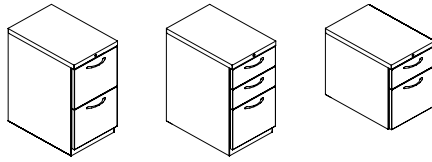

Essentials Support and Suspended Pedestals (page 71)

- Steel, ball-bearing slide suspension with full-extension on file drawers, 90% extension on box drawers.
- File drawer has high sides to allow front-to-back filing.
- Side-to-side filing utilizes follower block and cross rail both standard in all pedestals.
- Pencil tray included — one per pedestal with box drawers.
- Follower block (APFB80) sold separately.
- For improved aesthetics on 28"H pedestals, order flush mount kick plates.
- Support units have four leveling glides.
- Counterweight is standard in mobile pedestals.
- Support pedestals not used to support a worksurface require a counterweight kit — order separately.
- Box drawers have adjustable divider.
- Caster package available to field convert support pedestals to mobile.
- Standard core removable locks.

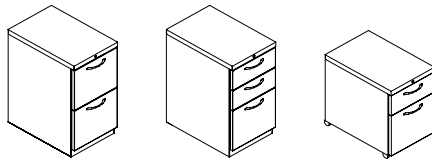

Essentials Mobile Pedestals (page 71)

- Steel, ball-bearing slide suspension with full-extension on file drawers, 90% extension on box drawers.
- File drawer has high sides to allow front-to-back filing.
- Side-to-side filing utilizes follower block and cross rail both standard in all pedestals.
- Pencil tray included — one per pedestal with box drawers.
- Follower block (APFB80) sold separately.
- Counterweight is standard in mobile pedestals.
- Box drawers have adjustable divider.
- Rear casters swivel, front casters are fixed.
- Standard core removable locks.
- If using 28"H Essentials mobile pedestals underneath a panel mounted worksurface on Stride®, Terrace®, or Optimize™ the panel glides will need to be extended a minimum of ¼" to allow for the mobile pedestals to slide underneath the worksurface.
- Adjustable glide kit available to field convert mobile pedestals to freestanding.
- Casters on box/file mobile pedestal require installation.
- For improved aesthetics on 28"H pedestals, order flush mount kick plates.

Essentials™ Pedestals

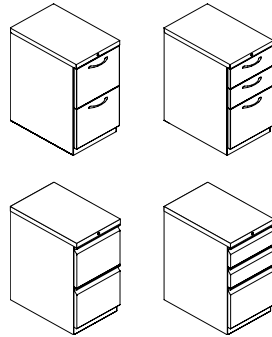

Essentials Basic Support Pedestals (page 72)

- Support pedestals have fully enclosed tops.
- Steel, ball-bearing slide suspension with 90% extension on file drawers, and 75% extension on box drawers.
- Follower block (APFB80), pencil tray (A2280-000), and adjustable divider (PD80) for box drawers sold separately.
- Side-to-side filing utilizes two cross rails (AP519495) sold separately.
- File drawer has high sides to allow front-to-back filing.
- Support pedestals not used to support a worksurface require a counterweight kit sold separately.
- Caster package available to field convert support pedestals to mobile.
- Standard core removable locks.
- Adjustable Glide Kit available to field convert mobile pedestals to freestanding.
- For improved aesthetics on 28"H pedestals, order flush mount kick plates.

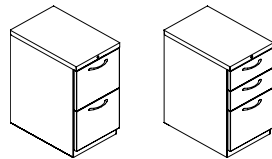

Essentials Basic Mobile Pedestals (page 72)

- Steel, ball-bearing slide suspension with 90% extension on file drawers, and 75% extension on box drawers.
- Follower Block (APFB80), pencil tray (A2280-000), and adjustable divider (PD80) for box drawers sold separately.
- Side-to-side filing utilizes two cross rails (AP519495) sold separately.
- File drawer has high sides to allow front-to-back filing.
- Counterweight is standard in mobile pedestals.
- Support pedestals not used to support a worksurface require a counterweight kit sold separately.
- Caster package available to field convert support pedestals to mobile.
- Standard core removable locks.
- If using 28"H Essentials mobile pedestals underneath a panel mounted worksurface on Stride®, Terrace®, or Optimize™ the panel glides will need to be extended a minimum of ¼" to allow for the mobile pedestals to slide underneath the worksurface.
- Adjustable glide kit available to field convert 26⅞"H – 28"H mobile pedestals to freestanding.
- For improved aesthetics on 28"H pedestals, order flush mount kick plates.

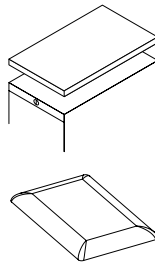

ASPT-24SC

Essentials Seat Cushion (page 73)

- Seat cushion provides quick and convenient additional seating.
- Seat cushion adds approximately 2"H to pedestal.
- YPPA prefix models have stitched corners and bumpers on bottom.
- ASPT prefix models have wrap around corners and attach with double-sided tape.
- COM yardage for seat cushion is ⅔ yard.

Essentials™ Personal Files

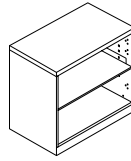

Essentials Personal Files (page 74)

- Matches inset drawer design of Essentials 28"H laterals.
- Worksurface supporting.
- Includes counterweights.
- Ball-bearing suspension on all drawers.
- Dimensions: 30"W x 18"D x 28"H.

Note: Essentials pedestals have a full front drawer design with a recessed base plate. Consider optional flush front kick plate for pedestals or towers if placed side-by-side with personal file.

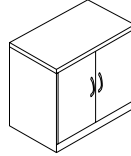

Essentials Personal File with Shelf (page 74)

- Available with or without doors.
- Opening is 23¼"H. It will accommodate one row of binders either above or below the shelf.
- Shelf is adjustable in 2" increments.
- Unit with doors is non-locking.

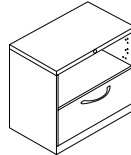

Essentials Personal File with Lateral Drawer (page 74)

- Available in two configurations: lateral drawer with open shelf and lateral drawer with file/box/box drawers.
- Lateral drawer is locking.
- One lock, located in the top, secures all drawers.
- Opening on units with shelf is 11½". It will accommodate standard height binders.
- Box and file drawers can be reconfigured in the field for either right or left hand configuration.

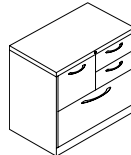

Essentials Personal File with Door and Shelf (page 74)

- Available with either file/file or box/box/file drawers and one door with a shelf.
- Specify left or right for door location.
- Opening on door side is 23¼"H. It will accommodate one row of binders either above or below the shelf.
- Shelf is adjustable in 2" increments.
- One lock, located in the top, secures all drawers.
- The door is non-locking.

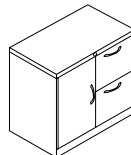
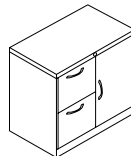
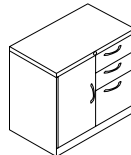
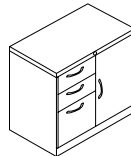

Essentials™ Personal Towers and Flush Front Kick Plates

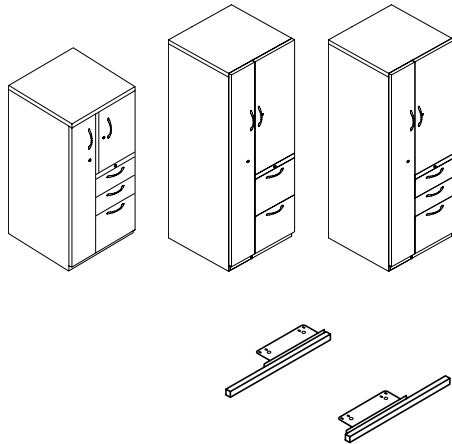

Essentials Personal Towers (page 75)

- Matches full front drawer design with recessed base plate of Essentials pedestals.
- Store personal items such as briefcases, coats, gym bags, lunch coolers.
- Three keyed alike locks secure doors and drawers.
- Available in right- or left-hand configurations.
- Cabinet door on 50" H Towers has one adjustable shelf.
- Cabinet door on 65" H has two adjustable shelves.
- 9" W wardrobe portion includes a coat rod.
- Ball-bearing suspension on all drawers.

Flush Front Kick Plate (page 75)

- Mounts to base of tower to provide a flush appearance to coordinate with laterals and personal files

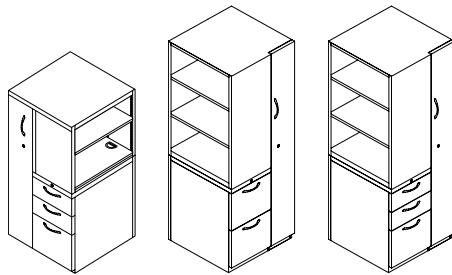

Essentials Personal Towers with Side Shelves (page 75)

- Matches full front drawer design with recessed base plate of Essentials pedestals.
- Store personal items such as briefcases, coats, gym bags, lunch coolers.
- Two keyed alike locks secure door and drawers.
- Available in right- or left-hand configurations.
- Wardrobe is 9" W.
- Open side shelf on 50" H tower has one adjustable shelf and one fixed shelf.
- Open side shelf on 65" H tower has two adjustable shelves and one fixed shelf.
- Wardrobe portion includes a coat rod.
- Ball-bearing suspension on all drawers.
- Tower to worksurface bracket mounts to user side of side access towers and is used to attach worksurface — order bracket separately.
- Flush front kick plates available — order separately. The kick plates provide a flush appearance to coordinate with laterals and personal files.

Dual-side Locking

Drawers and doors lock on both sides to prevent being pried open.

Interlock System

This mechanism inhibits roll-out of more than one drawer or shelf, either sequentially or simultaneously.

Fully Enclosed Bottom

Double bottoms are welded into all files for added rigidity.

Four Hex-head Leveling Glides

Leveling glides can be adjusted from outside or inside the case. Because of the hex-head design of the stem, leveling can be done even when the file is fully loaded. Range is 1".

Suspension

Telescoping, ball-bearing slides.

Core Removable Locks

Core removable lock feature allows key numbers to be easily changed in the field which facilitates installation.

Omit Lock Core

Files can be shipped with lock cores removed; cores can then be installed after files are placed. Laterals can be keyed alike with pedestals and overhead cabinets.

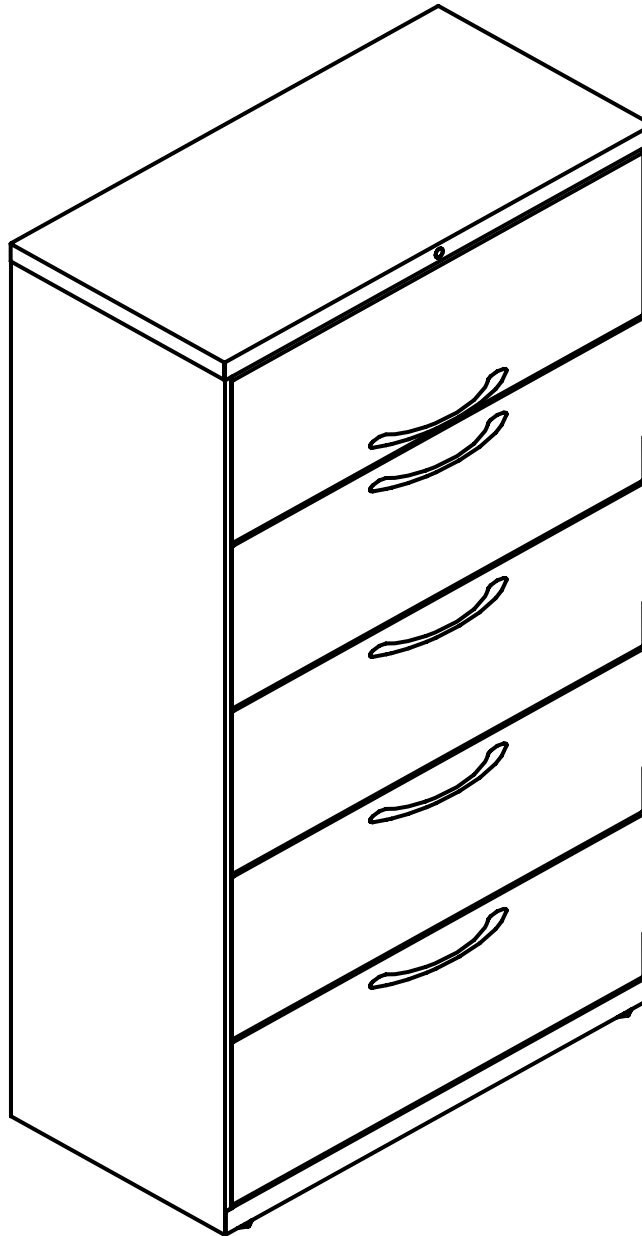

Four Pull Styles

Choice of four pull styles, also available on Essentials pedestals, allows for total design coordination on projects.

Side Knockouts

Files have knockouts on each side to allow easy ganging of freestanding units to inhibit tipping.

Inset Drawer Design

Drawers are inset inside the case. Base plate is flush with drawer fronts.

Paint Finish

Durable baked enamel finish is applied over rust-inhibiting phosphate pre-treatment.

Hanging Frames

Side-to-side come standard. Front-to-back filing option — hang rails are required.

Counterweights

Counterweights included and factory installed as required.

Drawer Interiors

Interiors and all accessories painted gray.

Essentials Lateral Files and Combination Files

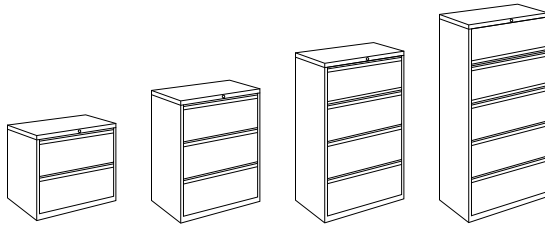

Essentials Lateral Files (page 76)

- Available in four pull options — arch, square, integral, and beveled pulls.
 - Load capacities per 12" opening per current ANSI/BIFMA Standards:
 - 30"W..... 86 lbs.
 - 36"W..... 105 lbs.
 - 42"W..... 124 lbs.
 - Clearance Dimensions – H x W 30 / 36 / 42" x D
 - Roll-out drawer..... 11¼" x 27⅞" / 33⅞" / 39⅞" x 16½"
 - Roll-out shelf..... 10½" x 27⅞" / 33⅞" / 39⅞" x 16½"
 - For locking specifications, see pages 180-182.
 - All files are 18" deep.
 - Laminate and veneer tops are available — order separately.
- Note:** Counterweights are included and factory installed as required.

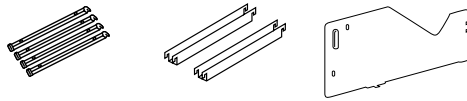

Essentials Accessories (page 76)

- All accessories are gray.
- Model L919491 used for front-to-back filing of all paper sizes in all drawer sizes except — letter in a 42"W case.
- Model L919492 for use in 42"W case for front-to-back filing of letter paper size

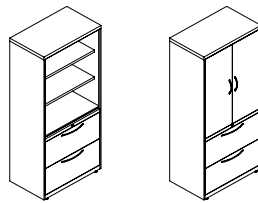

Essentials Combination Files (page 77)

- Combination cabinets match height of Essentials 5H laterals and storage cabinets.
- Combination cabinets are 30"W or 36"W and available as open shelves or hinged doors.
- Shelves are adjustable in 2" increments and are 15¼"D.
- Available in four pull styles — arch, square, integral, and beveled pulls.
- 64¼" combination cabinet has one fixed shelf and two adjustable shelves.
- Cabinets are fully assembled.
- Drawers feature three-part, telescoping, steel ball-bearing slides.
- Mechanical interlock inhibits opening more than one drawer at a time.
- For locking specifications, see pages 180-182.

Essentials Storage Cabinets, Overfiles, and Bookcases

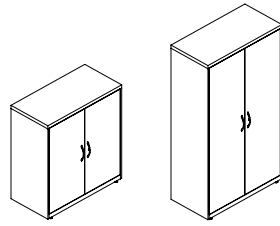

Essentials Storage Cabinets (page 77)

- Storage cabinet matches height of Essentials laterals and combination files.
- All cabinets are 36"W and are available in two heights.
- Shelves are adjustable in 2" increments and are 15¼"D.
- Available in four pull styles — arch, square, integral, and beveled pulls.
- Storage cabinets have the following number of adjustable shelves:

39⅞" high.....	2	64¼" high.....	4
----------------	---	----------------	---
- Cabinets are fully assembled.
- For locking specifications, see pages 180-182.

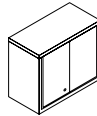

Essentials Overfiles (page 77)

- Cabinet shelf is adjustable in 1" increments up to 6" from center position. Shelves are 15¼"D x 1" thick.
- Cabinets are 18" deep (not for use on 18¾" deep full front files).
- Load capacities per shelf per current ANSI/BIFMA Standards:

30"W.....	122 lbs.
36"W.....	148 lbs.
42"W.....	173 lbs.
- Interior Dimensions – H x W 30 / 36 / 42" x D

25" x 28⅞" / 34⅞" / 40⅞" x 16½"

- Overfiles should be ganged to adjacent overfiles and/or anchored to lateral files, walls, or other rigid structures. Ganging knockouts and attaching bolts are provided for this purpose.
- Does not have leveling glides — must be installed on flat, level surface such as lateral file top.
- Cabinet doors have a full-height integral pull, standard with lock.
- For locking specifications, see pages 180-182.

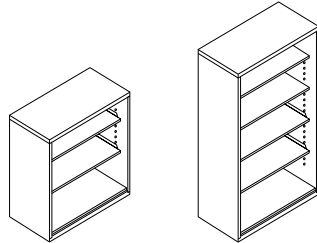

Essentials 18"D Bookcases (page 77)

- Essentials 18"D bookcases are same height as 3H or 5H Essentials laterals and storage cabinets.
- Essentials 18"D Bookcases are all 36"W with open shelves.
- Shelves are 1" thick. Interior height 34½"H or 59"H.
- Shelves adjust in 2" increments. Shelf load capacity 107 lbs.
- 39⅞"H unit has 2 adjustable shelves. 64¼"H unit has 4 adjustable shelves.
- Inside shelf dimension 34½"W x 15⅞"D.
- Bookcases are fully assembled.
- Bookcases include leveling glides with 1" of adjustment.

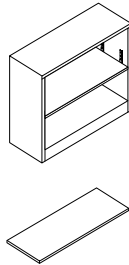

Essentials 12½"D Bookcases (page 77)

- Available in six heights from 29" to 81".
- All units case dimensions are 33⅞"W x 12⅞"D.
- Inside shelf dimension depth is 12⅞"D.
- Shelves adjust in ½" increments. Shelf load capacity 114 lbs.
- Bookcases have the following number of adjustable shelves:

29" high	1	59" high	3
41" high	2	71" high	4
47" high	3	81" high	4
- Shelves are ¾" thick. Interior 4¼" less than height.
- Meets or exceeds ANSI/BIFMA and ISTA performance standards.
- Bookcases do not include leveling glides.

Essentials Accessories

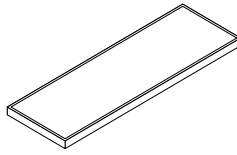

Metal Storage Tops — Laminate or Veneer (page 80)

- Tops are 1/4" thick. 18" or 36" deep.
- 60", 72" and 84" tops span two lateral files. Add "S2" suffix to add 1/8" to nominal width of top for freestanding applications.
- For use on 18" deep laterals, overfiles, bookcases, and cabinets.
- Veneer lateral file tops by Gunlocke®.
- Stratawood veneer has a consistent straight-grain pattern.
- Natural veneer will have cathedrals and as a natural material is subject to nature's quality control with variations in grain pattern and tone.
- Tops are field installed.
- 36"D tops are to be used for lateral files placed back-to-back.
- These tops will work with: Align metal case credenzas, Align lateral files, Essentials personal files, Essentials laterals, Essentials overfiles, and Essentials 18"D bookcases.
- Recommended to complement: veneer or flat edge laminate system worksurfaces.

Essentials™ Metal Storage

Support, Suspended, and Mobile Pedestals

For specification information see pages 60-63.

Ball-Bearing Suspension

GSA SIN 711-1, 711-2

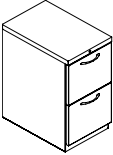
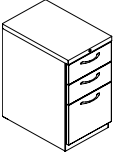
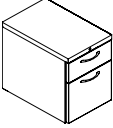
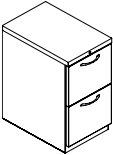
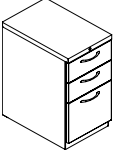
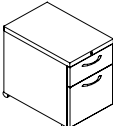
	Description	Model	Core Paint	Select Paint
			P1 List Price	P2 List Price
	Support Pedestals 28"H — File/File			
	18"D x 15"W*	PF198-182 □	\$ 641	\$ 703
	19"D x 15"W	PF198-202 □	\$ 641	\$ 703
	22"D x 15"W	PF198-232 □	\$ 668	\$ 730
	28"D x 15"W	PF198-302 □	\$ 688	\$ 750
	Note: 28"H pedestals have a higher base plate resulting in a taller overall cabinet height. Consideration must be given to ensure that units align visually with each other and selected laterals.			
	Support Pedestals 28"H — Box/Box/File			
	18"D x 15"W*	PF197-183 □	\$ 641	\$ 703
	19"D x 15"W	PF197-203 □	\$ 641	\$ 703
	22"D x 15"W	PF197-233 □	\$ 668	\$ 730
	28"D x 15"W	PF197-303 □	\$ 688	\$ 750
	Suspended Pedestals 19½"H — Box/File			
	18"D x 15"W*	PH149-182 □	\$ 535	\$ 597
	19½"D x 15"W	PH149-202 □	\$ 535	\$ 597
	22"D x 15"W	PH149-232 □	\$ 559	\$ 621
	Mobile Pedestal 28"H — File/File			
	18"D x 15"W*	PM188-182 □	\$ 668	\$ 730
	19"D x 15"W	PM188-202 □	\$ 668	\$ 733
	22"D x 15"W	PM188-232 □	\$ 692	\$ 757
	28"D x 15"W	PM188-302 □	\$ 714	\$ 779
	Mobile Pedestal 28"H — Box/Box/File			
	18"D x 15"W*	PM187-183 □	\$ 668	\$ 730
	19"D x 15"W	PM187-203 □	\$ 668	\$ 733
	22"D x 15"W	PM187-233 □	\$ 692	\$ 757
	28"D x 15"W	PM187-303 □	\$ 714	\$ 779
	Note: 28"H pedestals have a higher base plate resulting in a taller overall cabinet height. Consideration must be given to ensure that units align visually with each other and selected laterals.			
	Mobile Pedestal 22½"H — Box/File			
	22½"D x 15"W	PM119-232 □	\$ 568	\$ 633

*18"D Pedestals do not accommodate legal size filing.

How to specify — Select the Model Number from above.	1st Option: Drawer Pull: A Arch B Beveled I Integral S Square	2nd Option: Paint:  See inside front cover for finishes.	3rd Option: Pull Color: Arch Pull EL Matte Silver E4 Black Square Pull EL Matte Silver	4th Option: Lock Option: STD Standard OMT Omit Lock Core (Deduct \$18)
	P 1 - .	.	P .	.

Examples: PH149-202B.P02.STD PF197-203A.P27.EL.STD
 PM187-203B.P02.STD PM187-233A.P4J.E4.STD

Essentials™ Metal Storage

Basic Support and Mobile Pedestals

For specification information see pages 60-63.

GSA SIN 711-1

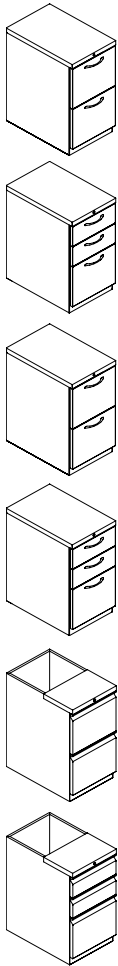

Description	Model	Core Paint P1 List Price	Select Paint P2 List Price
Support Pedestals 28"H — File/File			
19"D x 15"W	AF398-202 □	\$ 577	\$ 639
22"D x 15"W	AF398-232 □	\$ 597	\$ 659
Support Pedestals 28"H — Box/Box/File			
19"D x 15"W	AF397-203 □	\$ 577	\$ 639
22"D x 15"W	AF397-233 □	\$ 597	\$ 659
Mobile Pedestal 28"H — File/File			
19"D x 15"W	AM388-202 □	\$ 588	\$ 653
22"D x 15"W	AM388-232 □	\$ 609	\$ 674
Mobile Pedestal 28"H — Box/Box/File			
19"D x 15"W	AM387-203 □	\$ 588	\$ 653
22"D x 15"W	AM387-233 □	\$ 609	\$ 674
Support Pedestals 28"H — File/File (partial top)			
19"D x 15"W	P281520FFB	\$ 526	\$ 586
22"D x 15"W	P281523FFB	\$ 545	\$ 605
Support Pedestals 28"H — Box/Box/File (partial top)			
19"D x 15"W	P281520BBFB	\$ 526	\$ 586
22"D x 15"W	P281523BBFB	\$ 545	\$ 605

Note: 28"H pedestals have a higher base plate resulting in a taller overall cabinet height. Consideration must be given to ensure that units align visually with each other and selected laterals.

<p>How to specify — Select the Model Number from above.</p>	<p>1st Option: Drawer Pull: A Arch B Beveled I Integral S Square Partial top models limited to "B" Beveled pulls.</p>	<p>2nd Option: Paint: C S See inside front cover for finishes.</p>	<p>3rd Option: Pull Color: <u>Arch Pull</u> EL Matte Silver E4 Black <u>Square Pull</u> EL Matte Silver</p>	<p>4th Option: Lock Option: STD Standard OMT Omit Lock Core (Deduct \$18)</p>
<p>_____</p>	<p>_____ .</p>	<p>P _____ .</p>	<p>_____ .</p>	<p>_____</p>







Examples: AF397-203B.P27.STD AF398-232A.P02.E4.STD
AM387-203I.P27.STD AM388-232A.P02.EL.STD

Essentials™ Metal Storage

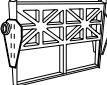
Tops and Accessories

For specification information see pages 60-63.
(See page 185 for COM pricing on upholstery grades 13-23.)

GSA SIN 711-1, 711-2

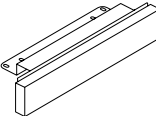
Description	Model	List Price	Select Paint P2 List Price
Accessories			
 Pencil Tray (Black only)	A2280-000 <input type="checkbox"/>	\$ 29	N/A
 Follower Block — 1 Pack	APFB80 <input type="checkbox"/>	\$ 29	N/A
 Box Drawer Divider — 2 Pack	PD80 <input type="checkbox"/>	\$ 25	N/A
 Hanging File Cross Rails — 2 Pack (for side-to-side filing)	AP519495 <input type="checkbox"/>	\$ 23	N/A
 Adjustable Glides — 4 Pack for 26 1/2"H – 28"H Mobile Pedestals Field-installable Hardware included	AP20040AG <input type="checkbox"/>	\$ 47	N/A
 Caster Package — Field Installable Four Casters (2 swivel, 2 fixed)	AP1050CST <input type="checkbox"/>	\$ 30	N/A
 Counterweights for 22 1/2"H and 26 1/2"H Pedestals (do not specify color)	2282-300	\$ 147	N/A
Counterweights for 28"H Pedestals (do not specify color)	2282-400	\$ 161	N/A
 Flush Front Kick Plate for 28"H Pedestals	ETKP28H	\$ 82	\$ 91

Description	Model	L1 List Price	L2 List Price	L3 List Price
Laminate Tops – Flat Edge (for mobile and freestanding pedestals)				
 19 1/2"D x 15"W x 1 1/4" Thick	PT17-20TTP <input type="checkbox"/>	\$ 167	\$ 175	\$ 184
22 1/2"D x 15"W x 1 1/4" Thick	PT17-23TTP <input type="checkbox"/>	\$ 191	\$ 200	\$ 210
28 1/2"D x 15"W x 1 1/4" Thick	PT17-29TTP <input type="checkbox"/>	\$ 225	\$ 237	\$ 248

Description	Model	List Price											
		Grade 1	Grade 2	Grade 3	Grade 4	Grade 5	Grade 6	Grade 7	Grade 8	Grade 9	Grade 10	Grade 11	Grade 12
Seat Cushion — For Metal Mobile Pedestals only (Specify seating fabric — no leathers)													
23 1/2"D	ASPT-24SC	\$ 168	\$ 191	\$ 208	\$ 220	\$ 238	\$ 254	\$ 269	\$ 286	\$ 303	\$ 318	\$ 336	\$ 367
29 1/2"D	ASPT-30SC	\$ 175	\$ 192	\$ 205	\$ 214	\$ 227	\$ 239	\$ 249	\$ 262	\$ 275	\$ 286	\$ 299	\$ 322
17"D	YPPA1815SC	\$ 142	\$ 169	\$ 185	\$ 202	\$ 221	\$ 237	\$ 256	\$ 275	\$ 291	\$ 311	\$ 354	\$ 399
23"D	YPPA2415SC	\$ 168	\$ 196	\$ 213	\$ 231	\$ 251	\$ 268	\$ 287	\$ 308	\$ 324	\$ 345	\$ 391	\$ 438
29"D	YPPA3015SC	\$ 175	\$ 205	\$ 223	\$ 242	\$ 263	\$ 280	\$ 300	\$ 322	\$ 339	\$ 361	\$ 410	\$ 459

<p>How to specify — Select the Model Number from above. Add FC to end of Seat Cushion model for CTB133 / Boston Fire Code / NY/NJ Port Authority (\$100 extra)</p>	<p>1st Option: Laminate (Tops only): See inside front cover for finishes.</p>	<p>2nd Option: Edge Color (Flat and T-Mold Edge only): See inside front cover for finishes.</p>	<p>3rd Option: Paint: <input type="checkbox"/> <input type="checkbox"/> Kick Plate only. See inside front cover for finishes.</p>	<p>Only Option for Seat Cushion: Upholstery: Specify seating upholstery.</p>
_____ . _____ .	_____ .	_____	P _____ .	_____

Example: PT17-20TTP.TM20.E4 YPPA2415SC.CU62

Shippable by small-package carrier.

Essentials™ Metal Storage

Personal Files

For specification information see pages 61-64.

GSA SIN 711-3

Description	Model	Core Paint	Select Paint
		P1 List Price	P2 List Price
28"H Personal File with Shelf — 30"W x 18"D			
File Center with Shelf — Open	EPF23018SO	\$ 728	\$ 807
File Center with Shelf — with Doors (non-locking)	EPF23018D □	\$ 896	\$ 975

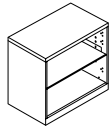

EPF23018S

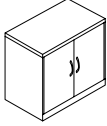

EPF23018DA

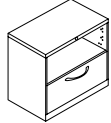

EPF23018SLFA

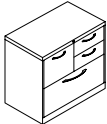

EPF23018A

28"H Personal File with Lateral Drawer — 30"W x 18"D

Open Shelf / Lateral Drawer	EPF23018SLF □	\$ 1019	\$ 1098
File/Box/Box / Lateral Drawer	EPF23018FBBL □	\$ 1236	\$ 1315

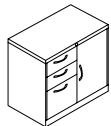

EPF23018BBFDA

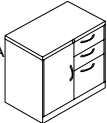

EPF23018DBBFA

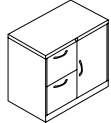

EPF23018FFDA

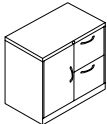

EPF23018DFFA

28"H Personal File with Door and Shelf — 30"W x 18"D

Box/Box/File Left / Door with Shelf Right	EPF23018BBFD □	\$ 1365	\$ 1444
Door with Shelf Left / Box/Box/File Right	EPF23018DBBF □	\$ 1365	\$ 1444
File/File Left / Door with Shelf Right	EPF23018FFD □	\$ 1365	\$ 1444
Door with Shelf Left / File/File Right	EPF23018DFF □	\$ 1365	\$ 1444

<p>How to specify — Select the Model Number from above.</p>	<p><i>1st Option:</i> Pull: (if applicable): A Arch B Beveled I Integral S Square</p>	<p><i>2nd Option:</i> Paint: See inside front cover for finishes.</p>	<p><i>3rd Option:</i> Pull Color (if applicable): Arch Pull EL Matte Silver E4 Black Square Pull EL Matte Silver</p>	<p><i>4th Option:</i> Lock Type (if applicable): STD Standard OMT Omit Lock Core (Deduct \$18)</p>
<p>E P F 2 3 0 1 8 </p>	<p>P </p>	<p>E </p>	<p> </p>	

Example: EPF23018FBBLB.P02.STD EPF23018SO.P7C EPF23018FFDA.P02.E4.STD

ALIGN METAL SPEC
ALIGN PRICING
ESSENTIALS SPEC
ESSENTIALS PRICING
VERTICALS
INVOLVE SPEC
INVOLVE PRICING
ALIGN VENEER

Essentials™ Metal Storage

Personal Towers

For specification information see pages 61-65.

GSA SIN 711-3

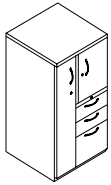

ET42424LFF

Description	Model	Core Paint	Select Paint
		P1 List Price	P2 List Price
50"H Personal Tower — 24"W x 24"D — 4-High			
Wardrobe Left / File/File	ET42424LFF □	\$ 1895	\$ 2084
Wardrobe Right / File/File	ET42424RFF □	\$ 1895	\$ 2084
Wardrobe Left / Box/Box/File	ET42424LBBF □	\$ 1895	\$ 2084
Wardrobe Right / Box/Box/File	ET42424RBBF □	\$ 1895	\$ 2084

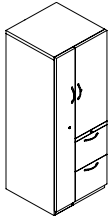

ET52424LFF

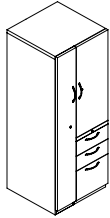

ET52424LBBF

65"H Personal Tower — 24"W x 24"D — 5-High			
Wardrobe Left / File/File	ET52424LFF □	\$ 2303	\$ 2492
Wardrobe Right / File/File	ET52424RFF □	\$ 2303	\$ 2492
Wardrobe Left / Box/Box/File	ET52424LBBF □	\$ 2303	\$ 2492
Wardrobe Right / Box/Box/File	ET52424RBBF □	\$ 2303	\$ 2492

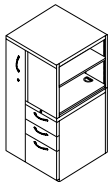

ET42424LOBBF

50"H Personal Tower with Open Side Shelves — 24"W x 24"D — 4-High			
Wardrobe Left / File/File / Open Side Shelves	ET42424LOFF □	\$ 1979	\$ 2170
Wardrobe Right / File/File / Open Side Shelves	ET42424ROFF □	\$ 1979	\$ 2170
Wardrobe Left / Box/Box/File / Open Side Shelves	ET42424LOBBF □	\$ 1979	\$ 2170
Wardrobe Right / Box/Box/File / Open Side Shelves	ET42424ROBBF □	\$ 1979	\$ 2170

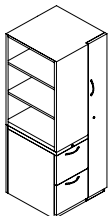

ET52424ROFF

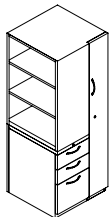

ET52424ROBBF

65"H Personal Tower with Open Side Shelves — 24"W x 24"D — 5-High			
Wardrobe Left / File/File / Open Side Shelves	ET52424LOFF □	\$ 2428	\$ 2619
Wardrobe Right / File/File / Open Side Shelves	ET52424ROFF □	\$ 2428	\$ 2619
Wardrobe Left / Box/Box/File / Open Side Shelves	ET52424LOBBF □	\$ 2428	\$ 2619
Wardrobe Right / Box/Box/File / Open Side Shelves	ET52424ROBBF □	\$ 2428	\$ 2619

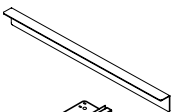

Tower to Worksurface Bracket			
Tower Bracket for 24"D	ETB2W1	S	\$ 68 \$ 83



ETKP24WL

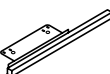

ETKP24WR

Flush Front Kick Plate for 24"W Towers			
For Wardrobe Left Models	ETKP24WL	S	\$ 120 \$ 132
For Wardrobe Right Models	ETKP24WR	S	\$ 120 \$ 132

How to specify — Select the Model Number from above.	1st Option: Pull (if applicable): A Arch B Beveled I Integral S Square	2nd Option: Paint: G S See inside front cover for finishes.	3rd Option: Pull Color: Arch Pull EL Matte Silver E4 Black Square Pull EL Matte Silver	4th Option: Lock Type (if applicable): STD Standard OMT Omit Lock Core (Deduct \$18 per core)
E	P	E

Examples: ET52424LFFA.P02.EL.STD ET42424LFFI.P4J.STD ETKP24WL.P02

S Shippable by small-package carrier.







Essentials™ Metal Storage

Lateral Files

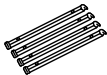
For specification information see pages 66-67 and 69.

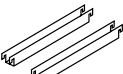
GSA SIN 711-3

Exterior Width	Model	Core Paint		Select Paint	
		P1 List Price	P2 List Price	P2 List Price	P2 List Price
27½"H; two 12" drawers with hanging frames side-to-side — 2-High					
30"W x 18"D	ELF230N □	\$ 826		\$ 905	
36"W x 18"D	ELF236N □	\$ 913		\$ 992	
42"W x 18"D	ELF242N □	\$ 1057		\$ 1136	
28"H; two 12" drawers with hanging frames side-to-side — 2-High					
30"W x 18"D	ELF830N □	\$ 826		\$ 905	
36"W x 18"D	ELF836N □	\$ 913		\$ 992	
42"W x 18"D	ELF842N □	\$ 1057		\$ 1136	
Note: 28"H worksurface supporting laterals have a taller base plate resulting in a taller overall cabinet height. Consideration must be made to ensure that units align visually within the workstation.					
39½"H; three 12" drawers with hanging frames side-to-side — 3-High					
30"W x 18"D	ELF330N □	\$ 1082		\$ 1195	
36"W x 18"D	ELF336N □	\$ 1220		\$ 1333	
42"W x 18"D	ELF342N □	\$ 1409		\$ 1522	
52½"H; four 12" drawers with hanging frames side-to-side — 4-High					
30"W x 18"D – No posting shelf	ELF430N □	\$ 1375		\$ 1525	
36"W x 18"D – No posting shelf	ELF436N □	\$ 1562		\$ 1712	
42"W x 18"D – No posting shelf	ELF442N □	\$ 1791		\$ 1941	
30"W x 18"D – With posting shelf	ELF430P □	\$ 1410		\$ 1560	
36"W x 18"D – With posting shelf	ELF436P □	\$ 1583		\$ 1733	
42"W x 18"D – With posting shelf	ELF442P □	\$ 1821		\$ 1971	
64½"H; 12" roll-out shelf with receding door top opening, balance 12" drawers and hanging frames side-to-side — 5-High					
30"W x 18"D – No posting shelf	ELF530N □	\$ 1740		\$ 1924	
36"W x 18"D – No posting shelf	ELF536N □	\$ 1959		\$ 2143	
42"W x 18"D – No posting shelf	ELF542N □	\$ 2279		\$ 2463	
30"W x 18"D – With posting shelf	ELF530P □	\$ 1780		\$ 1964	
36"W x 18"D – With posting shelf	ELF536P □	\$ 1998		\$ 2182	
42"W x 18"D – With posting shelf	ELF542P □	\$ 2312		\$ 2496	

ESSENTIALS	Description	Model	List Price
	Single-Rail Hanging File Racks (4/pack)	L919491 	\$ 40
	Double-Rail Hanging File Racks (2/pack)	L919492 	\$ 40
	Dividers (3/pack)	L919703 	\$ 41

<p>How to specify — Select the Model Number from above.</p>	<p>1st Option: Pull (if applicable):</p> <p>A Arch B Beveled I Integral S Square</p>	<p>2nd Option: Paint (if applicable):</p> <p>C S See inside front cover for finishes.</p>	<p>3rd Option: Pull Color (if applicable):</p> <p>Arch Pull EL Matte Silver E4 Black</p> <p>Square Pull EL Matte Silver</p>	<p>4th Option: Lock Option (if applicable):</p> <p>STD Standard — Random Keyed OMT Omit Lock Core (Deduct \$18)</p>
<p>_____</p>	<p>_____ .</p>	<p>P _____ .</p>	<p>_____ .</p>	<p>_____</p>

Examples: ELF230NB.P02.STD L919491

For specification information see pages 67-69.

GSA SIN 711-3

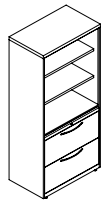

ECF536N

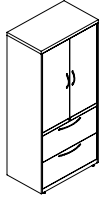

ECF536H

Description	Model	Number of Adj. Shelves	Core Paint P1 List Price	Select Paint P2 List Price
64¼"H Combination Files w/Open Shelves — 18"D – 5-High				
30"W	ECF530N □	2	\$ 1494	\$ 1678
36"W	ECF536N □	2	\$ 1695	\$ 1879

64¼"H Combination Files w/Hinged Doors — 18"D – 5-High				
30"W	ECF530H □	2	\$ 1632	\$ 1816
36"W	ECF536H □	2	\$ 1854	\$ 2038

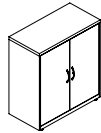

ESC336

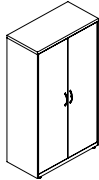

ESC536

Storage Cabinets — 36"W x 18"D				
39¼"H	ESC336 □	2	\$ 849	\$ 962
64¼"H	ESC536 □	4	\$ 1242	\$ 1426

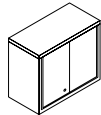

Overfile Cabinets — 27⅞"H, cabinet with sliding doors and lock; one adjustable shelf				
30"W x 18"D	EOF3018		\$ 859	\$ 953
36"W x 18"D	EOF3618		\$ 908	\$ 1002
42"W x 18"D	EOF4218		\$ 948	\$ 1042

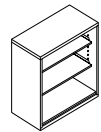

EBC336

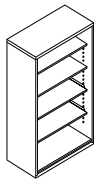

EBC536

Bookcases — 36"W x 18"D				
36"W x 39¼"H	EBC336	2	\$ 734	\$ 847
36"W x 64¼"H	EBC536	4	\$ 1086	\$ 1270

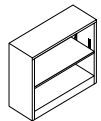

Bookcases — 34½"W x 12½"D				
29"H	EBC30	1	\$ 530	\$ 609
41"H	EBC42	2	\$ 639	\$ 752
59"H	EBC60	3	\$ 813	\$ 963
71"H	EBC72	4	\$ 849	\$ 1033
81"H	EBC82	4	\$ 880	\$ 1099

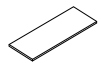

Shelves — ¾" Thick				
Package of one	ESH34	N/A	\$ 67	\$ 80

<p>How to specify — Select the Model Number from above.</p>	<p>1st Option: Drawer Pull (if applicable): A Arch B Beveled I Integral S Square</p>	<p>2nd Option: Paint: ☉ ☉ See inside front cover for finishes.</p>	<p>3rd Option: Pull Color (if applicable): Arch Pull only EL Matte Silver E4 Black Square Pull EL Matte Silver</p>	<p>4th Option: Lock Type (if applicable): STD Standard OMT Omit Lock Core, not available on overfile cabinets (Deduct \$18)</p>
--	--	--	--	---

Examples: ECF530NA.P02.EL.STD ESC336A.P27.E4.STD EBC30.P27

For specification information see page 69.

GSA SIN 711-3

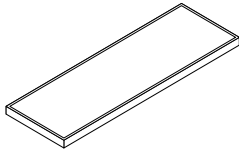

Width	Model	Surface Type (L=Laminate, W=Wood)	Laminate			Veneer		
			L1 List Price	L2 List Price	L3 List Price	V1 List Price	V3 List Price	V5 List Price
18"D Lateral File Tops for Essential™ Lateral Files								
24"W	AFNLFTP-2418	L or W	\$ 231	\$ 245	\$ 258	\$ 603	\$ 738	\$ 823
30"W	AFNLFTP-3018	L or W	\$ 255	\$ 268	\$ 282	\$ 641	\$ 699	\$ 779
36"W	AFNLFTP-3618	L or W	\$ 287	\$ 301	\$ 317	\$ 659	\$ 718	\$ 799
42"W	AFNLFTP-4218	L or W	\$ 313	\$ 329	\$ 346	\$ 684	\$ 747	\$ 834
48"W	AFNLFTP-4818	L or W	\$ 340	\$ 357	\$ 373	\$ 687	\$ 843	\$ 942
54½"W	AFNLFTP-5418	LS2 or WS2	\$ 343	\$ 359	\$ 376	\$ 706	\$ 863	\$ 964
60"W	AFNLFTP-6018	L or W	\$ 358	\$ 377	\$ 394	\$ 738	\$ 804	\$ 899
66½"W	AFNLFTP-6618	LS2 or WS2	\$ 370	\$ 387	\$ 405	\$ 736	\$ 897	\$ 999
72"W	AFNLFTP-7218	L or W	\$ 389	\$ 410	\$ 428	\$ 766	\$ 835	\$ 935
84"W	AFNLFTP-8418	L or W	\$ 511	\$ 538	\$ 562	\$ 813	\$ 888	\$ 988
36"D Lateral File Tops for Essential Lateral Files								
24"W	AFNLFTP-2436	L or W	\$ 403	\$ 423	\$ 443	\$ 909	\$ 1114	\$ 1216
30"W	AFNLFTP-3036	L or W	\$ 444	\$ 468	\$ 488	\$ 954	\$ 1155	\$ 1290
36"W	AFNLFTP-3636	L or W	\$ 503	\$ 530	\$ 552	\$ 988	\$ 1197	\$ 1337
42"W	AFNLFTP-4236	L or W	\$ 544	\$ 573	\$ 598	\$ 1083	\$ 1314	\$ 1467
48"W	AFNLFTP-4836	L or W	\$ 567	\$ 592	\$ 618	\$ 1078	\$ 1314	\$ 1433
54½"W	AFNLFTP-5436	LS2 or WS2	\$ 592	\$ 618	\$ 644	\$ 1095	\$ 1334	\$ 1454
60"W	AFNLFTP-6036	L or W	\$ 627	\$ 660	\$ 688	\$ 1131	\$ 1369	\$ 1530
66½"W	AFNLFTP-6636	LS2 or WS2	\$ 639	\$ 666	\$ 693	\$ 1128	\$ 1372	\$ 1494
72"W	AFNLFTP-7236	L or W	\$ 676	\$ 711	\$ 741	\$ 1177	\$ 1428	\$ 1595
84"W	AFNLFTP-8436	L or W	\$ 889	\$ 933	\$ 977	\$ 1221	\$ 1482	\$ 1653

Particle board construction with laminate and flat edge trim on all sides or veneer surface and veneer edge on all sides.

Note: Add Suffix "S2" to 60"W - 84"W model numbers to add ½" to nominal width of top to span 2 storage units – no upcharge.

<p>How to specify — Select the Model Number from above.</p>	<p>1st Option: Laminate or Veneer Type and Finish: See inside front cover for finishes. S prefix for Stratawood N prefix for Natural</p>	<p>2nd Option: Edge: (on laminate tops only) See inside front cover for finishes.</p>
--	---	--

Examples: AFNLFTP-3018L.LT3B.E9 AFNLFTP-5418LS2.LT3B.E9

Shippable by small-package carrier.

Vertical Files

The A990 and A940 vertical files offer two contemporary solutions to your filing needs. Both series are built to handle the demands of today's busy office. From rugged, full-extension, ball-bearing suspensions, to reinforced frames and kickplates, these files set the standard for reliability, efficiency, and durability. Whisper-like drawer action is quiet testimony to the three-part telescoping, ball-bearing slide suspension, which generate almost effortless movement. Locks can be keyed alike (optional). See pages 180-182.

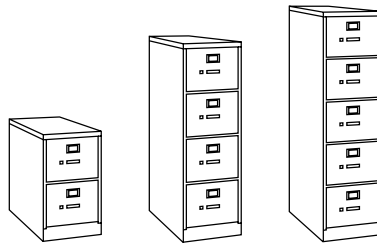

A990 Series Vertical Files (page 82)

- High capacity files with heavy-duty suspensions.
- 28½" D case depth with 27 front-to-back filing inches per drawer.
- Letter or legal sizes available.
- Three-part telescoping, ball-bearing slide suspension.
- Bright aluminum drawer pulls, label holders, and thumb latch.
- Standard interchangeable core removable locks.
- Accepts hanging files. High drawer sides hold hanging file folders without use of hangrails.
- Adjustable follower block on ¾" centers.
- 7-point case reinforcement (6 vertical uprights, plus kickplate).
- Baked enamel finish over rust-inhibiting phosphate pre-treatment.
- Models meet or exceed ANSI/BIFMA and ISTA performance standards.

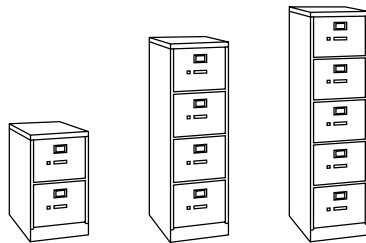

A940 Series Vertical Files (page 82)

- Files with heavy-duty suspensions.
- 26½" D case depth with 25 front-to-back filing inches per drawer.
- Letter or legal sizes available.
- Three-part telescoping, ball-bearing slide suspension.
- Bright aluminum drawer pulls, label holders, and thumb latch.
- Baked enamel finish over rust-inhibiting phosphate pre-treatment.
- Models meet or exceed ANSI/BIFMA and ISTA performance standards.
- Standard interchangeable core removable locks.
- Accepts hanging files. High drawer sides hold hanging file folders without use of hangrails.
- Adjustable follower block on ¾" centers.
- 5-point case reinforcement (4 vertical uprights, plus kickplate).

Vertical Metal Storage

A990 / A940 Series Vertical Files

For specification information see page 81.

GSA SIN 711-3



Description	Model	List Price
29"H 2 Drawer, 28½"D — A990 Series		
15"W Letter	A992	\$ 711
18¼"W Legal	A992C	\$ 807
52"H 4 Drawer, 28½"D — A990 Series		
15"W Letter	A994	\$ 991
18¼"W Legal	A994C	\$ 1108
60"H 5 Drawer, 28½"D — A990 Series		
15"W Letter	A995	\$ 1319
18¼"W Legal	A995C	\$ 1465
29"H 2-Drawer, 26½"D — A940 Series		
15"W Letter	A942	\$ 433
18¼"W Legal	A942C	\$ 505
52"H 4-Drawer, 26½"D — A940 Series		
15"W Letter	A944	\$ 615
18¼"W Legal	A944C	\$ 706
60"H 5-Drawer, 26½"D — A940 Series		
15"W Letter	A945	\$ 895
18¼"W Legal	A945C	\$ 1025

How to specify —
Select the Model Number from above.

1st Option:

Paint:



See inside front cover for finishes.

_____ .

P _____ .

Example: A992.P27

Shippable by small-package carrier.

INVOLVE

Introduction

Overview	83-85
Statement of Line.....	14-15
Features and Dimensions.....	86-91

Working With Involve — Specification Information

Working with Laminate Wood Storage	92-101
Working with Worksurfaces and Supports	102-103
Working with Screens.....	104-105
Working with Powered Credenzas.....	106-115

Involve Wood Storage — Pricing Information

Pedestals	116
17½" H Credenzas	117
24" H Credenzas	118-119
28" H Credenzas	120-121
42" H Credenzas and Bookcase	122
Bookcases	123
Pedestal and Credenza Tops and Cushions.....	124
Accessories — Counterweights, Brackets, CAM Covers	125
Metal Shelves and Pullout Shelves	126-127
Soft Seating Bases, Cushions and Accessories.....	128-129
Towers — 42½" H, 50" H, 57½" H, 65" H, 72½" H	130-134
Stacking Storage	135
Overhead Storage and Shelves.....	136-137
Stanchions, Horizontal Wall Mount Brackets, LED Lights	138
Overhead Backs and Shelves	139
Hutches and Tackboards.....	140-141

Involve Worksurfaces and Supports — Pricing Information

Laminate — Primary, Taper, EZ View, Sweep	142-143
Veneer — Primary, Taper, EZ View, Sweep	144-145
Worksurface Supports	146-147

Involve Screens — Pricing Information

Modesty Panels.....	148-149
Privacy and Divider Panels	150
Tackable Taskpanels.....	151

Involve Powered Credenzas — Pricing Information

24" H Powered Credenzas	152-153
28" H Powered Credenzas	154
Tops for Powered Credenzas	155
Electrical & Data for Powered Credenzas	156-157

Laminate Storage

Cubby and Shelves	158
-------------------------	-----

Where, how, and even what defines work is changing constantly. It's obvious that businesses are trying to understand what it means to successfully change with the culture and trends.

With Involve, we set out to discover how furniture can be used today as an impetus to an organizations change and yet perform well into the future as the organization continues to evolve.

Involve... one solution for all your needs.

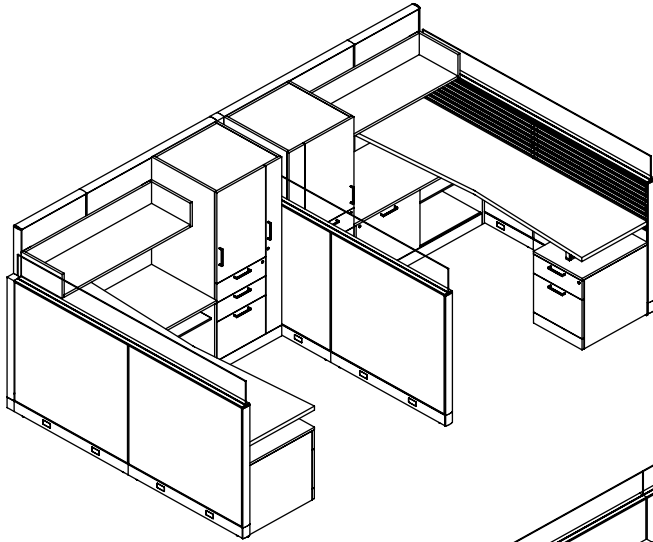

**Share work
as it happens.**

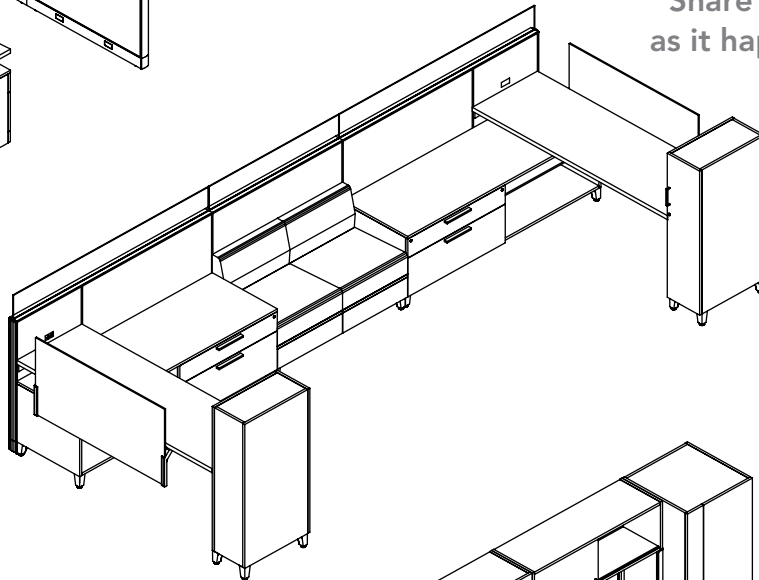

**Involve is as comfortable in a corner
or shared office as in an open plan.**

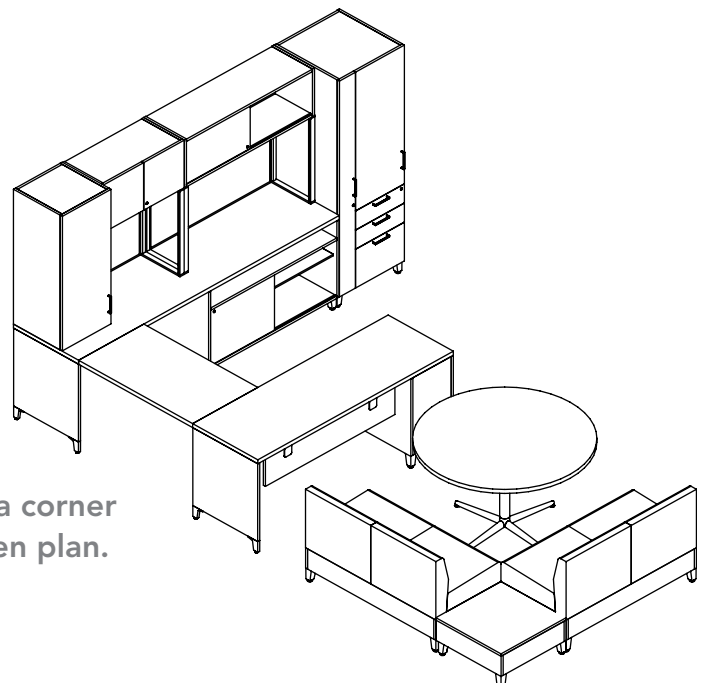

A Fresh Approach

Furniture needs to work today with a fresh approach and innovative features. But support of tomorrow's needs is vitally important.

- Expand functionality of systems furniture, energize existing installs, and support changing work styles with Involve. Take existing investment and add functionality and relevance by changing out a few key pieces.
- The soft seating can be used within panel walls or pulled into freestanding or huddle room applications. The same casegoods work in private office or open plan configurations.
- Modularity of components allows for flexing of product application into the future. Involve lets you design for collaboration now while building in opportunity for future head count growth.

Changing Work Styles

From editing to brainstorming, number crunching to researching, today's work doesn't just happen in a task chair pulled up to a desk surface.

- Tired of the stodgy cubicle, users should be inspired by a fresh approach with innovative features that feel like furniture and less like a system.
- A task chair works for one job function and lounge seating works better for another. Involve supports the preferred posture for these activities while maintaining the desired home base for individuals.
- Untethered from the primary workstation, sharing of information can happen spontaneously around a screen or face to face. Involve components can be used across the floorplan offering the user multiple places to go as they work.

Get inspired by Involve.

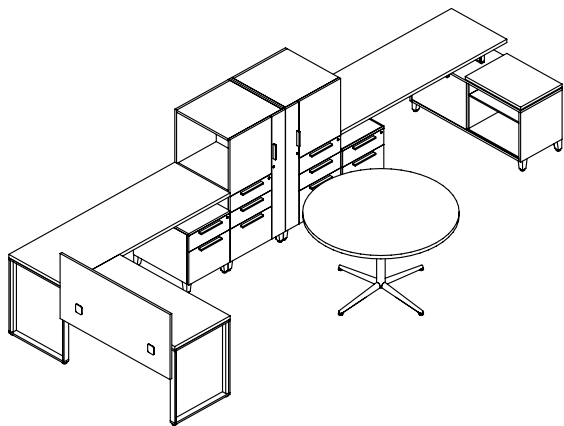

Involve's modular design accommodates all the different ways work gets done.

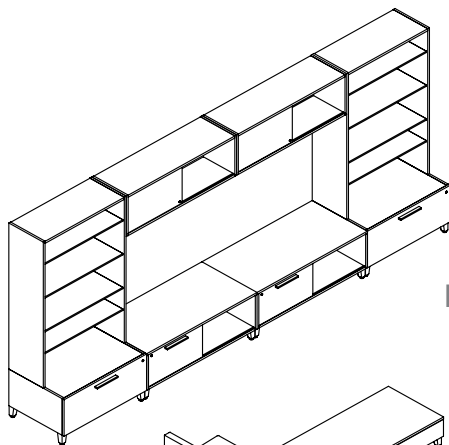
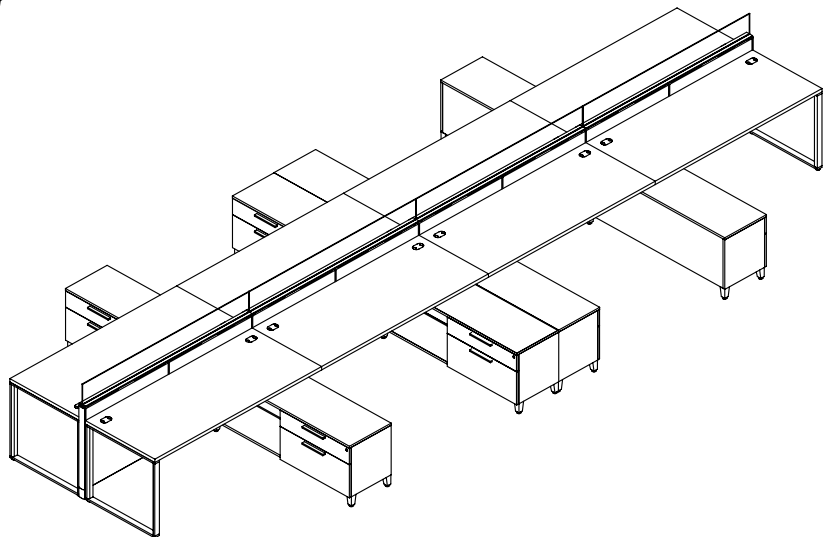

Involve moves out of dedicated user spaces to create comfortable, functional meeting areas.

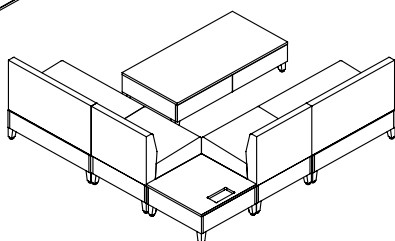

Style		17½"H Credenza	24"H Credenza	28"H Credenza	42"H Credenza
Widths	Open	—	18", 24", 30", 36"	18", 24", 30", 36"	—
	Box/Lateral	—	30"	—	—
	Box/Box/Lateral	—	36"	24", 30"	—
	Box/Box/Project/Lateral	—	—	36"	—
	Lateral (1, 2, or 3 drawers)	30", 36"	—	30", 36"	36"
	Lateral/Open Cubby	48", 60", 72"	48", 60", 72"	—	—
	Combination	—	—	—	—
	Sliding Door w/shelf	—	36", 48"	36", 48"	—
	Closed (Table)	24"	—	—	—
	High Door/Low Open	—	—	—	—
Depths (some units 18"D or 24"D only)		18", 24"	18", 24"	18", 24"	18"
Pulls — Arch, Square Straight		Yes	Yes	Yes	Yes
Lock Options:					
	Lock	Standard	Standard	Standard	Standard
	Omit Core	Optional	Optional	Optional	Optional
	Master Keyed Lock	Standard	Standard	Standard	Standard
	Removable Lock Core	Yes — with special key	Yes — with special key	Yes — with special key	Yes — with special key
	Dual-Sided Locking	—	Yes	Yes	—
Suspension		Ball Bearing	Ball Bearing	Ball Bearing	Ball Bearing
Drawer Front Construction		¼" thick Laminate	¼" thick Laminate	¼" thick Laminate	¼" thick Laminate
Hinged Door Construction		¼" thick Laminate	¼" thick Laminate	¼" thick Laminate	¼" thick Laminate
Hex-head Glide		Yes	Yes	Yes	Yes
Counterweights		Required on freestanding applications	Required on freestanding applications	Required on most freestanding applications	Not required
Drawer Interiors:					
	Box Drawer	—	2¼"H	2¼"H	—
	Project Drawer	2⅝"H	—	2⅝"H	—
	Lateral Drawer	9"H	9"H	9"H	9"H
Front-to-Back Filing		Standard	Standard	Standard	Standard
Filing Options		Letter, Legal	Letter, Legal	Letter, Legal	Letter, Legal

Style		Pedestal	Towers	Bookcases	Stacking
Heights		24", 28"	50", 57½", 65", 72½"	65", 72½"	20", 27½", 35", 42½"
Widths	Open	18"	—	30", 36"	—
	Box/File	15½", 18"	—	—	—
	Box/Box/File	15½", 18"	18", 24"	—	—
	File/File	28"	18", 24"	—	—
	Shelves	—	—	30", 36"	18", 24"
	Shelves and Lateral (1 drawer)	—	—	30", 36"	—
Depths (some units 18"D or 24"D only)		18", 24"	18", 24"	15", 24"	18"
Pulls — Arch, Square, Straight		Yes	Yes	Yes	Yes
Lock Options:					
	Lock	Standard	Standard	Standard	No
	Omit Core	Optional	Optional	Optional	No
	Master Keyed Lock	Standard	Standard	Standard	No
	Removable Lock Core	Yes — with special key	Yes — with special key	Yes — with special key	No
Suspension		Ball Bearing	Ball Bearing	Ball Bearing	—
Drawer Front Construction		¼" thick Laminate	¼" thick Laminate	¼" thick Laminate	¼" thick Laminate
Hinged Door Construction		¼" thick Laminate	¼" thick Laminate	¼" thick Laminate	¼" thick Laminate
Hex-head Glide		Yes	Yes	Yes	—
Counterweights		Required on freestanding applications	Not required	Not required	Not required
Drawer Interiors:					
	Box Drawer	—	2¼"H	2¼"H	—
	File Drawer	9"H	9"H	9"H	—
Front-to-Back Filing		Standard	Standard	Standard	—
Filing Options		Letter	Letter	Letter, Legal	—

Interior Dimensions for Credenzas, Pedestals, Towers, Bookcases, Stacking Storage, and Seat Bases

[GSA Reference Page](#)

Description	Height	Depth — 18"D, 24"D	Width
CREDENZAS Open	24"H — 17 ³ / ₈ "	24"H — 17 ³ / ₈ ", 23 ³ / ₈ "	18" exterior = 16 ³ / ₈ " interior
	28"H — 22 ³ / ₈ "	28"H — 17 ³ / ₈ ", 23 ³ / ₈ "	24" exterior = 22 ³ / ₈ " interior
			30" exterior = 28 ³ / ₈ " interior
			36" exterior = 34 ³ / ₈ " interior
			48" exterior = 46 ³ / ₈ " interior
Single Lateral	Lateral — 9"	30"W Lateral — 14", 17 ¹ / ₂ " 36"W Lateral — 12", 17 ¹ / ₂ "	30" exterior = 26 ³ / ₈ " interior 36" exterior = 32 ³ / ₈ " interior
Single Lateral w/Open Side	Lateral — 9"	24"W Lateral — 12", 17 ¹ / ₂ "	48" exterior = 43 ³ / ₈ " interior
	Open Side — 12"	30"W Lateral — 14", 17 ¹ / ₂ "	60" exterior = 55 ³ / ₈ " interior
		36"W Lateral — 12", 17 ¹ / ₂ " Open Side — 16 ³ / ₈ ", 22 ³ / ₈ "	72" exterior = 67 ³ / ₈ " interior
Sliding Door	24"H — 17 ³ / ₈ "	16", 22"	36" exterior = (2) 16 ³ / ₈ " interior 48" exterior = (2) 22 ³ / ₈ " interior
Box/Box/Lateral	Box — 2 ¹ / ₄ "	Box — 15"	36" exterior = 32 ³ / ₈ " interior
	Project — 2 ³ / ₈ "	Project — 15"	
	Lateral — 9"	Lateral — 12", 17 ¹ / ₂ "	
Box/Lateral w/Open Side	Box — 2 ³ / ₈ "	Box — 15"	48" exterior = 43 ³ / ₈ " interior
	Lateral — 9"	24"W Lateral — 12", 17 ¹ / ₂ "	60" exterior = 55 ³ / ₈ " interior
	Open Side — 17 ³ / ₈ "	30"W Lateral — 14", 17 ¹ / ₂ "	72" exterior = 67 ³ / ₈ " interior
		36"W Lateral — 12", 17 ¹ / ₂ " Open Side — 16 ³ / ₈ ", 22 ³ / ₈ "	
File/File	(2) File — 9"	30"W Lateral — 14", 17 ¹ / ₂ "	30" exterior = 26 ³ / ₈ " interior
		36"W Lateral — 12", 17 ¹ / ₂ "	36" exterior = 32 ³ / ₈ " interior
Box/Box/File Support and Box/Box/Project/Lateral Support	Box — 2 ¹ / ₄ "	Box — 15"	24" exterior = 20 ³ / ₈ " interior
	Project — 2 ³ / ₈ "	Project — 15"	30" exterior = 26 ³ / ₈ " interior
	File — 9"	24"W Lateral — 12", 17 ¹ / ₂ "	36" exterior = 32 ³ / ₈ " interior
		30"W Lateral — 14", 17 ¹ / ₂ " 36"W Lateral — 12", 17 ¹ / ₂ "	
Combination	Cabinet — 12"	Cabinet — 16 ³ / ₈ ", 22 ³ / ₈ "	48" exterior = 45 ³ / ₈ " interior
	Project — 2 ³ / ₈ "	Project — 15"	
	Open Side — 4 ³ / ₈ "	Open Side — 16 ³ / ₈ ", 22 ³ / ₈ "	
Open Bookcase	29 ¹ / ₂ "	17 ³ / ₈ "	48" exterior = (2) 22 ³ / ₈ " interior
Open w/Sliding Door and Shelves	29 ¹ / ₂ "	16"	48" exterior = (2) 22 ³ / ₈ " interior
Lateral (42 high)	(3) File — 9"	15"	36" exterior = 32 ³ / ₈ " interior
PEDESTALS Mobile and Support	Box — 2 ¹ / ₄ "	Mobile — 15"	Mobile — 12 ³ / ₈ "
	File — 9 ³ / ₈ "	Support — 15", 19"	Support — 12 ³ / ₈ " and 14 ³ / ₈ "
TOWERS Hinged Door and Side Access	Box — 2 ¹ / ₄ "	15", 19"	14 ³ / ₈ "
BOOKCASES Open Bookcase	65"H — 58 ¹ / ₂ "	14 ³ / ₈ "	30" exterior = 28 ³ / ₈ " interior
	72"H — 66"		36" exterior = 34 ³ / ₈ " interior
Bookcase with Lateral	65" BC — 45 ³ / ₄ "	Bookcase — 14 ³ / ₈ "	30" exterior = 28 ³ / ₈ " interior
	72" BC — 53 ³ / ₄ "	Lateral — 17 ¹ / ₂ "	36" exterior = 34 ³ / ₈ " interior
	Lateral — 9"		
STACKING Hinged Door or Open (Actual exterior ht. 1/4" less than nominal)	20"H-18 ¹ / ₄ "H 35"H-33 ¹ / ₄ "H	16 ³ / ₈ "	18" exterior = 16 ³ / ₈ " interior
	27 ¹ / ₂ "H-25 ³ / ₄ "H 42 ¹ / ₂ "H-40 ³ / ₄ "H		24" exterior = 22 ³ / ₈ " interior
SEAT BASES Open	4 ³ / ₄ "	17 ³ / ₈ "	24" exterior = 22 ³ / ₈ " interior
			36" exterior = 34 ³ / ₈ " interior
			48" exterior = 46 ³ / ₈ " interior
Drawer	2 ³ / ₈ "	15"	24" exterior = 20 ³ / ₈ " interior
			36" exterior = 32 ³ / ₈ " interior
			48" exterior = (2) 20 ³ / ₈ " interior

Involve® Laminate Wood Storage

Features and Dimensions

Load Capacity for Laminate Wood Credenzas, Pedestals, Bookcases, Stacking Storage, Towers, and Overheads [GSA Reference Page](#)

Product Description	Style	Depth	15½"W	18"W	24"W	30"W	36"W	48"W	60"W	72"W	
11"H CREDENZAS	Open Table	18"D					57lbs.	77 lbs.			
		24"D					76 lbs.	103 lbs.			
17½"H CREDENZAS	Lateral	18"D			48 lbs.	62 lbs.	76 lbs.				
		24"D			56 lbs.	73 lbs.	89 lbs.				
	Lateral/Open Cubby	18"D							125 lbs.	159 lbs.	193 lbs.
		24"D							161 lbs.	205 lbs.	248 lbs.
24"H CREDENZAS	Box	18"D			14 lbs.	19 lbs.	23 lbs.				
		24"D			18 lbs.	23 lbs.	29 lbs.				
	Lateral	18"D			48 lbs.	62 lbs.	76 lbs.				
		24"D			56 lbs.	73 lbs.	89 lbs.				
	Box/Lateral/Open	18"D							170 lbs.	217 lbs.	263 lbs.
		24"D							222 lbs.	282 lbs.	342 lbs.
	Open	18"D		81 lbs.	111 lbs.	141 lbs.	170 lbs.				
		24"D		109 lbs.	150 lbs.	190 lbs.	230 lbs.				
	Sliding Door w/shelf	18"D						157 lbs.	213 lbs.		
		24"D						216 lbs.	293 lbs.		
28"H CREDENZAS	Box	18"D			14 lbs.	19 lbs.					
		24"D			18 lbs.	23 lbs.					
	Project Drawer	18"D						23 lbs.			
		24"D						29 lbs.			
	Lateral	18"D				62 lbs.	76 lbs.				
		24"D				73 lbs.	89 lbs.				
	Open Cubby w/shelf	18"D		104 lbs.	142 lbs.	180 lbs.	218 lbs.				
		24"D		140 lbs.	192 lbs.	243 lbs.	294 lbs.				
Sliding Door w/shelf	18"D						210 lbs.	285 lbs.			
	24"D						287 lbs.	389 lbs.			
42"H CREDENZAS	Lateral	18"D					76 lbs.				
24"H PEDESTALS	Box Mobile	18"D	9 lbs.								
	File Mobile	18"D	29 lbs.								
	Box Freestanding	18"D		10 lbs.							
		24"D		13 lbs.							
	File Freestanding	18"D		35 lbs.							
		24"D		44 lbs.							
28"H PEDESTALS	Box Support	18"D	9 lbs.	10 lbs.							
		24"D	11 lbs.	13 lbs.							
	File Support	18"D	29 lbs.	35 lbs.							
		24"D	37 lbs.	44 lbs.							
BOOKCASES	65"H with/Lateral (15"D upper)	24"D				367 lbs.	445 lbs.				
	72½"H with/Lateral (15"D upper)	24"D				413 lbs.	501 lbs.				
	65"H Open (all shelves)	15"D				377 lbs.	456 lbs.				
	72½"H Open (all shelves)	15"D				426 lbs.	516 lbs.				
STACKING STORAGE	with/Doors (All units are non-locking.)	18"D									
TOWERS	Box Drawer	18"D		10 lbs.	14 lbs.						
		24"D		13 lbs.	18 lbs.						
	File Drawer	18"D		35 lbs.	48 lbs.						
		24"D		44 lbs.	56 lbs.						
	50"H Wardrobe Section	18"D			63 lbs.						
		24"D			86 lbs.						
	57½"H Wardrobe Section	18"D			74 lbs.						
		24"D			101 lbs.						
	65"H Wardrobe Section	24"D			116 lbs.						
	72½"H Wardrobe Section	24"D			131 lbs.						
	65"H Full Width Wardrobe	24"D		360 lbs.	492 lbs.						
	72½" Full Width Wardrobe	24"D		407 lbs.	556 lbs.						

Involve® Laminate Wood Storage

Features and Dimensions

Load Capacity by Unit (continued)

GSA Reference Page

Product Description	Style	Depth	15½"W	18"W	24"W	30"W	36"W	48"W	60"W	72"W
SEAT BASES	Drawers	24"D			13 lbs.		22 lbs.	27 lbs.		
	Open	24"D			31 lbs.		48 lbs.	64 lbs.		
OVERHEADS	7½"H Open Bin			30 lbs.	38 lbs.	46 lbs.	55 lbs.	63 lbs.		
	7½"H Book Shelf			36 lbs.	46 lbs.	56 lbs.	65 lbs.	75 lbs.		
	15"H Slider Bin			61 lbs.	78 lbs.	95 lbs.	112 lbs.	129 lbs.	163 lbs.	
	15"H Binder Box w/shelf			70 lbs.	88 lbs.	107 lbs.	123 lbs.	142 lbs.	180 lbs.	
	15"H Hinged Door			64 lbs.	81 lbs.	104 lbs.	113 lbs.	130 lbs.	165 lbs.	
	15"H Dual Access w/Slider Door									
	15"H Dual Access Open					129 lbs.		175 lbs.	221 lbs.	
	22½"H Hinged Door			99 lbs.	126 lbs.	153 lbs.	176 lbs.	203 lbs.	257 lbs.	

Quantity of Locks for Laminate Wood Credenzas, Pedestals, Bookcases, Stacking Storage, Towers, and Overheads

Note: Open units and shelves are non-locking and are therefore not included in the list below.

	Style	15½"W	18"W	24"W	30"W	36"W	42"W	48"W	60"W	72"W
17½"H CREDENZAS	Lateral (1 drawer)				1 lock	1 lock				
	Lateral/Open Cubby							1 lock	1 lock	1 lock
24"H CREDENZAS	Box/Lateral				1 lock					
	Box/Box/Lateral					2 locks				
	Box/Lateral/Open							1 lock	1 lock	1 lock
	Sliding Door w/shelf					1 lock		1 lock		
28"H CREDENZAS	Box/Box/Lateral			1 lock						
	Box/Box/Project/Lateral					2 locks				
	Lateral (2 drawer)				1 lock	1 lock				
	Sliding Door w/shelf					1 lock		1 lock		
42"H CREDENZAS	Lateral (3 drawer)							1 lock		
24"H PEDESTALS	Box/File	1 lock	1 lock							
28"H PEDESTALS	Box/Box/File	1 lock	1 lock							
	File/File	1 lock	1 lock							
BOOKCASES	with/Lateral				1 lock	1 lock				
STACKING STORAGE	with/Doors (All units are non-locking.)									
TOWERS	Wardrobe/Hinged Door/Box/Box/File			2 locks						
	Wardrobe/Hinged Door/File/File			2 locks						
	Wardrobe/Side Access/File/File			2 locks						
	Wardrobe/Side Access/Box/Box/File			2 locks						
	Wardrobe			1 lock						
	Hinged Door/Box/Box/File		1 lock							
	Hinged Door/File/File		1 lock							
	Side Access/File/File		1 lock							
OVERHEADS	Hinged Doors			1 lock	1 lock	1 lock	1 lock	2 locks	2 locks	
	Sliding Door			1 lock	1 lock	1 lock	1 lock	1 lock	1 lock	
	Dual Access w/Sliding Doors								2 locks	2 locks

Involve® Laminate Wood Storage

Working with Peds and Credenzas

GSA Reference Page

Credenzas and pedestals ship fully assembled except for tops on 28"H and 42"H units are ordered separately to allow one surface to span multiple credenzas and pedestals. Tops are available in laminate with flat edge detail.

Available in solid and woodgrain laminate colors. On units with fronts, you can select one laminate for the case and a second laminate for the drawer fronts and doors.

Tops for 28"H and 42"H units must be ordered separately and can span multiple units. Most units are available in 18" or 24" depths.

Optional ganging bracket can be used to gang credenzas or pedestals in line.

Units feature three styles of pull options — arch, square or straight; and either Terrace or Stride style legs.

Units can be shipped with lock cores removed; cores can be installed after units are in place. Core removable lock feature allows key numbers to be easily changed in the field.

Units are constructed from 3/4" thick high-pressure laminated particleboard with laser fused edge banding and European cam-and-pin construction.

Stride feet for Involve have sleeves to conceal the leveling glides which have a 1 1/8" leveling range. Terrace feet have a leveling range 2 1/4". The hex-head design of the stem allows leveling to be done even when the unit is fully loaded.

On two-tone casegoods, the credenza top including front "header" is the same color as the case on all credenzas that ship with a top. Example: Unit with frosty white case and charcoal walnut front has a frosty white top and header.

All drawers use full-extension slides. Interlocks are used where needed for stability.

Choose footed design or plinth base for storage that sits on the floor.

Internal shelves are painted metal and adjustable to three levels (unless noted as fixed).

Feet are recessed 3/4" from the front, 1/8" from the sides, and are flush to the back. On dual-access units feet are recessed 3/4" on front and back.

Single sided sliding door units are non-handed; open half depends on door position. Doors lock in either position.

Powered credenzas are available. See pages 499-509.

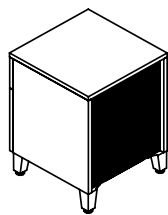

Finished back

Open and partially open units come assembled with a finished laminate back.

Units with drawers or doors come with an unfinished back that is recessed. A laminate back is available for units up to 28"H (ordered separately) for use when the back of the unit will be exposed.

Three pull styles are available: arch, square, and straight. Drawer pulls and feet are molded with post-consumer recycled resin and powder coated to provide a durable surface.



Arch Pull

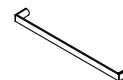

Square Pull

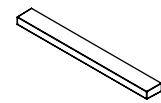

Straight Pull

Storage that sits on the floor is available with plinth base or feet. Footed design provides increased air flow. Two feet options are available to integrate with Terrace or Stride Systems.

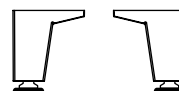

Terrace

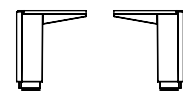

Stride

A seat cushion can be placed on the credenza or pedestal top for additional seating. **Soft seating units** are also available for use within the private office, open plan, reception areas, and beyond. Seat bases are ordered separately from seat base cushions and table tops. Seat bases can be used as tables when ordered with a side table top.

Seat Bases are ordered separately in widths of 24", 36", and 48". Seat Bases are 11"H x 24"D and are available with plinth base, Terrace® feet, or Stride® feet. Seat cushion(s) and/or table top(s) are ordered separately to complete the unit.

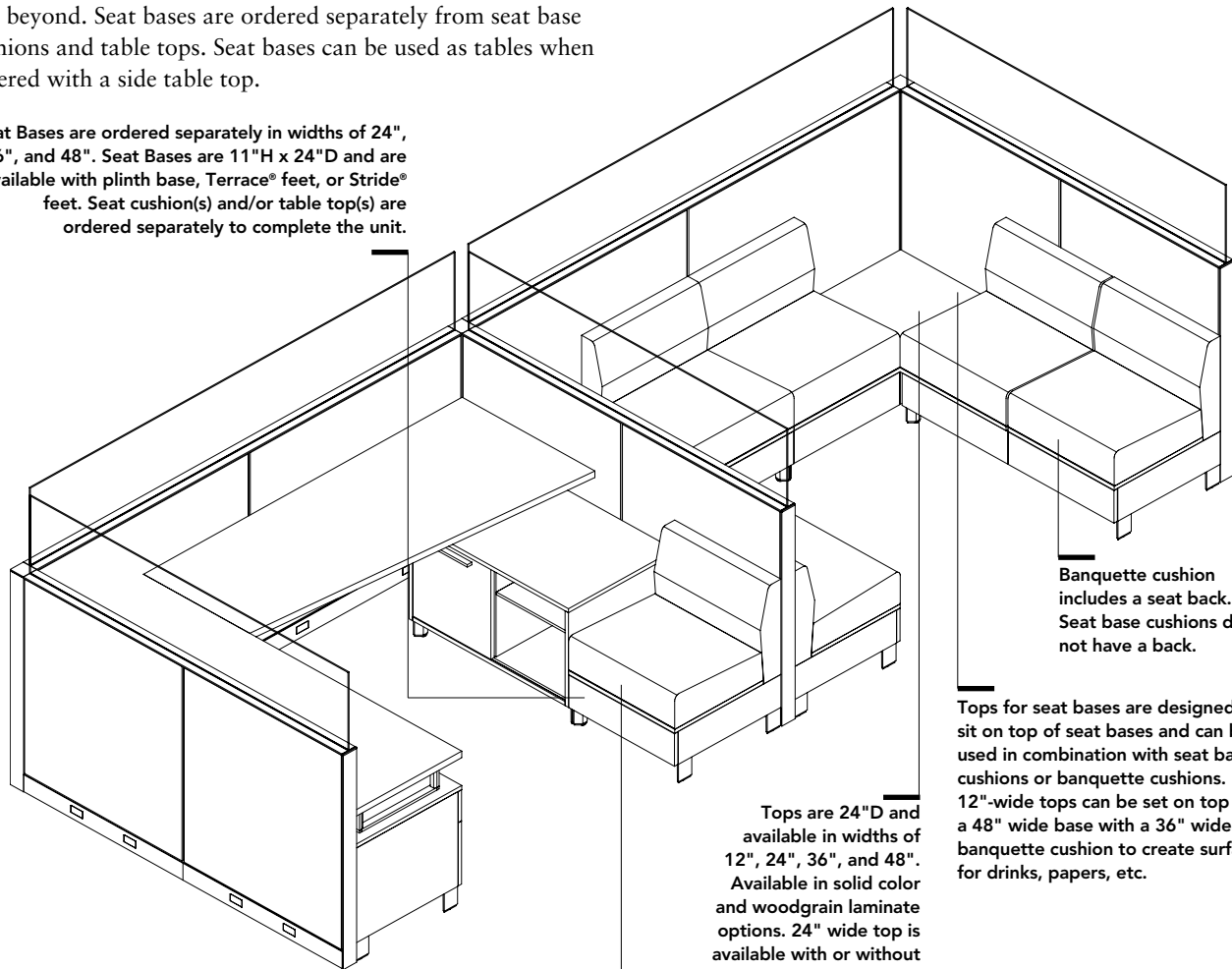

Seat cushions are designed to attach to the top of the seat bases. Offering includes: 24"W or 36"W banquette cushions or 24"W seat base cushions.

Tops are 24"D and available in widths of 12", 24", 36", and 48". Available in solid color and woodgrain laminate options. 24" wide top is available with or without power cutout. A power module is ordered separately.

Banquette cushion includes a seat back. Seat base cushions do not have a back.

Tops for seat bases are designed to sit on top of seat bases and can be used in combination with seat base cushions or banquette cushions. 12"-wide tops can be set on top of a 48" wide base with a 36" wide banquette cushion to create surface for drinks, papers, etc.

Seat base offering includes: with drawer or open. 48"W seat base with drawer has two drawers; design allows access to outbound drawers in corner applications. See illustration below showing four 48"W seat bases with 24"W cushions and tops in a U-shape configuration.

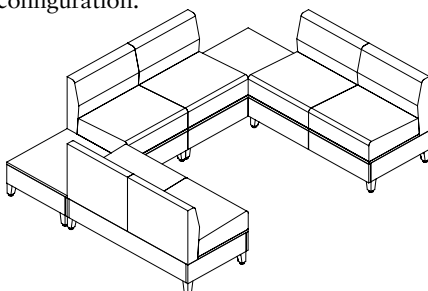

Seat bases are available in solid or woodgrain laminate options. Seat base with drawer can have a different laminate color on the drawer front than the case.

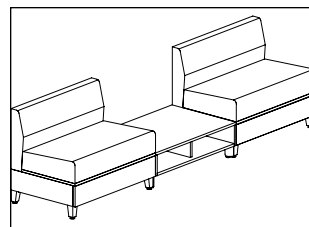

Open table is 11" high and is open at the front and back. Available in widths of 36" or 48" and depths of 18" and 24". Tables can be used to support electronics with back open for cord passage or can be used as a coffee table. 48" wide unit has a septum in the middle of the unit.

Corner table is used in a soft seating application. Corner table is 17½" high, 24" wide, and 24" deep. Illustration below is shown using plinth base units.

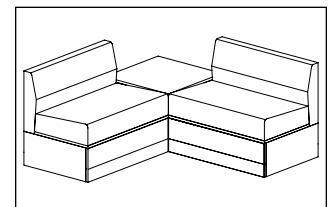

Involve® Laminate Wood Storage

Storage with Panel Frames

GSA Reference Page

Leg or plinth base models available. Leg base units are shown below.

Side-mounted Credenzas

Use 1 storage-to-panel bracket per credenza — 1 LH and 1 RH.

The minimum credenza size is 24"H x 36"W x 18"D.

With a mid-run floor support, the maximum panel run is 144".

Without a mid-run floor support, the maximum panel run is 96".

Overheads and shelves cannot be used with 24"H side mounted credenzas.

Worksurfaces (if specified) must be mounted on the same side of the parent run as the credenzas.

Panel frame maximum height is 65".

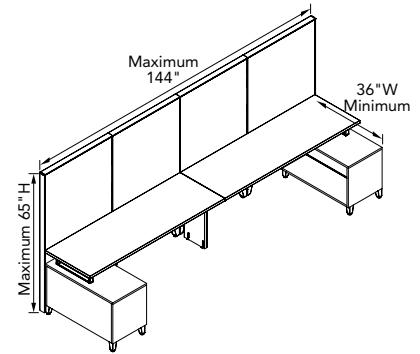

Back-mounted Credenzas — Modular

Use 2 storage-to-panel brackets per credenza — 1 LH and 1 RH.

The minimum credenza size is 24"H x 36"W x 24"D.

The maximum panel run between back-mounted credenzas is 72".

Overheads and shelves cannot be used with 24"H back mounted credenzas.

Worksurfaces (if specified) must be mounted on the same side of the parent run as the credenzas.

Panel frame maximum height is 65".

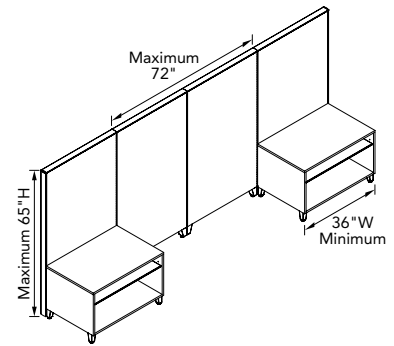

Back-mounted Credenzas — Off-Modular Ends

Use 1 storage-to-panel bracket per credenza — 1 LH and 1 RH.

The minimum credenza size is 24"H x 36"W x 24"D.

With a mid-run floor support, the maximum panel run is 144"

Without a mid-run floor support, the maximum panel run is 96".

Overheads and shelves cannot be used with 24"H back mounted credenzas.

Worksurfaces (if specified) must be mounted on the same side of the parent run as the credenzas.

Panel frame maximum height is 65".

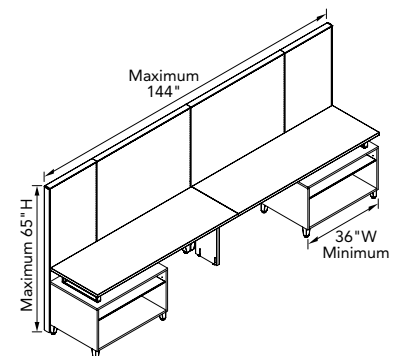

Note: Storage with unfinished metal backs require storage-to-panel bracket kit in order to mount to a panel. Left- or right-handed storage-to-panel bracket is determined by slots on panel — left-handed bracket required when attaching to left panel slots and right-handed bracket required when attaching to right panel slots.

Involve storage with unfinished backs require storage-to-panel bracket kit in order to mount to a panel.

Optional laminate back is available (ordered separately) for use when the back of the unit will be exposed.

Plinth base units require a different laminate back model than leg base units.

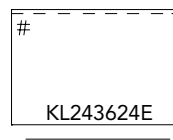
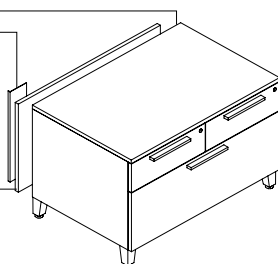

An example of a 2D CAD symbol for Involve is shown at left. Note the dashed line that represents the unfinished metal back. The pound sign indicates that counterweight kits may need to be added depending on the application. See page 99 for counterweight specification rules.

Leg or Plinth Base models available. Leg base units are shown below.

Side-mounted Credenzas — Modular for Overheads and Worksurfaces

Use 2 storage-to-panel brackets per credenza — 1 LH and 1 RH.

The minimum credenza size is 28"H x 36"W x 24"D.

28"H side mounted credenzas must be mounted modular when using overheads and worksurfaces on panels.

With a mid-run floor support, the maximum panel run is 144".

Without a mid-run floor support, the maximum panel run is 96".

Overheads, shelves, and worksurfaces must be mounted on the same side of the parent run as the credenzas.

Maximum overhead height is 15".

Panel frame maximum height is 65".

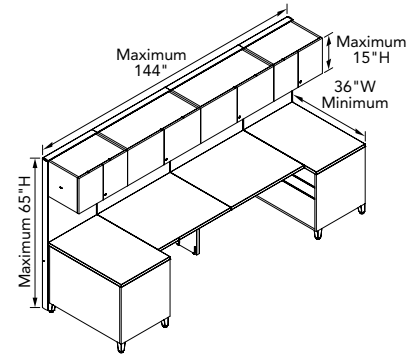

Back-mounted Credenzas — Modular for Overheads and Worksurfaces

Use 2 storage-to-panel brackets per credenza — 1 LH and 1 RH.

The minimum credenza size is 28"H x 36"W x 24"D.

With a mid-run floor support, the maximum panel run is 144".

Without a mid-run floor support, the maximum panel run is 96".

The maximum panel run between back-mounted credenzas is 72".

Overheads, shelves, and worksurfaces must be mounted on the same side of the parent run as the credenzas.

When using overhead cabinets or shelves, both sides of the run must have credenzas that are the same width as the panel.

Maximum overhead height is 15".

Panel frame maximum height is 65".

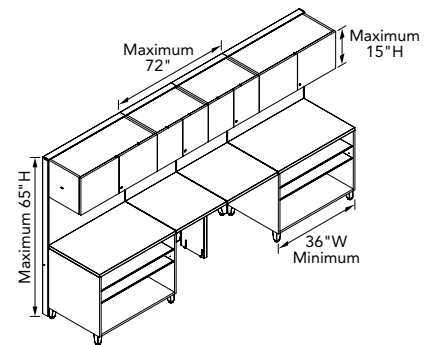

Side-mounted Credenzas — with Return Panel

Use 1 storage-to-panel bracket on credenza.

The minimum credenza size is 24"H x 36"W x 18"D.

The minimum size for panel return is 35"H x 36"W.

With a mid-run floor support, the maximum panel run is 144".

Without a mid-run floor support, the maximum panel run is 96".

Overheads and shelves cannot be used with 24"H side mounted credenzas.

Worksurfaces (if specified) must be mounted on the same side of the parent run as the credenzas.

Panel frame maximum height is 65".

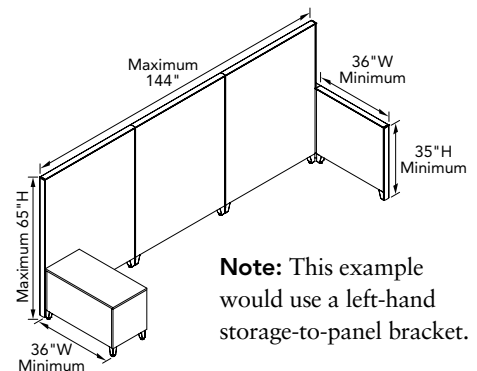

Note: This example would use a left-hand storage-to-panel bracket.

Side-mounted Credenzas — Modular for Overheads and Worksurfaces

Use 2 storage-to-panel brackets per credenza — 1 LH and 1 RH.

The minimum credenza size is 28"H x 36"W x 24"D.

The minimum size for panel return is 50"H x 36"W.

28"H side mounted credenzas must be mounted modular when using overheads and worksurfaces on panels.

With a mid-run floor support, the maximum panel run is 144".

Without a mid-run floor support, the maximum panel run is 72".

Overheads, shelves, and worksurfaces must be mounted on the same side of the parent run as the credenzas.

Maximum overhead height is 15".

Panel frame maximum height is 65".

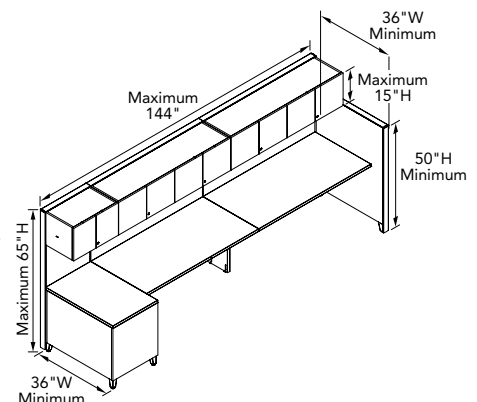

Aesthetic Alignment

Tower heights align with Stride® and Terrace® panel segmentation.

Construction and Options

See page 92 for Involve storage construction details; and base, pull, and finish options.

Shelves

Internal shelves are painted metal and adjustable to three levels.

Filing

File drawers can accommodate front-to-back letter filing.

Wardrobe Door

All 24"W towers have full-height wardrobe doors with a coat hook.

Core Removable Locks

Towers can be shipped with lock cores removed; cores can then be installed after towers are placed. Core removable lock feature allows key numbers to be easily changed in the field. It also facilitates installation.

Quantity of Lock Cores

Wardrobes with shelves, 18"W towers, and 12"W towers have one lock to secure door. All other towers have two locks — one secures the wardrobe door and the other secures all drawers.

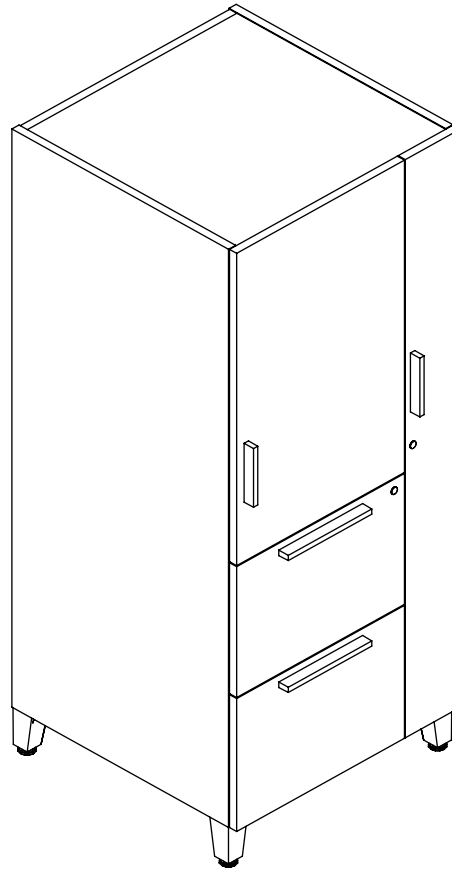

Configurations

Towers are available in five heights: 42½", 50", 57½", 65" and 72½"H. Drawer configurations include box/box/file and file/file with portion above drawers being a hinged door; 50"H and 57½"H units offer a side access option in place of front facing hinged door. All 24"W units with drawers have a full-height 6"W wardrobe; 18"W units do not. Full wardrobes with 2 adjustable shelves and a coat hook are available in 65"H and 72½"H. 12"W units include 2 coat hooks and must be panel mounted or attached to a credenza or worksurface. Left- and right-handed units available for all configurations.

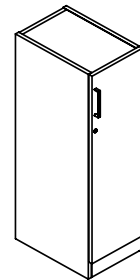

Worksurface Support

Tower can accommodate addition of an "L" tower bracket or tower rail.

An "L" tower bracket can be ordered separately and fitted to any tower to support worksurfaces at 29½"H.

A tower rail can be ordered separately and fitted to any tower to support worksurfaces at a height range of 27½"H to 30½"H.

See Stride Price List page 167 for visuals of a "L" tower bracket and a tower rail.

Number of Adjustable Shelves in Tower

Unit Height	Sides Access	Front Access	12" Wide
42½"H	N/A	N/A	1
50"H	1	0*	2
57½"H	1	1	2
65"H	N/A	2	2
72½"H	N/A	2	N/A

*Shelf can be ordered separately on pages 126 and 127.

Stacking storage ships fully assembled. Units are designed to be placed on top of a worksurface or credenza and are attached with double-sided tape. Units line up on-module with Stride® and Terrace® elevations when mounted atop everything except a 24" high credenza. Units are available with hinged doors, hinged doors with side display, and open configurations.

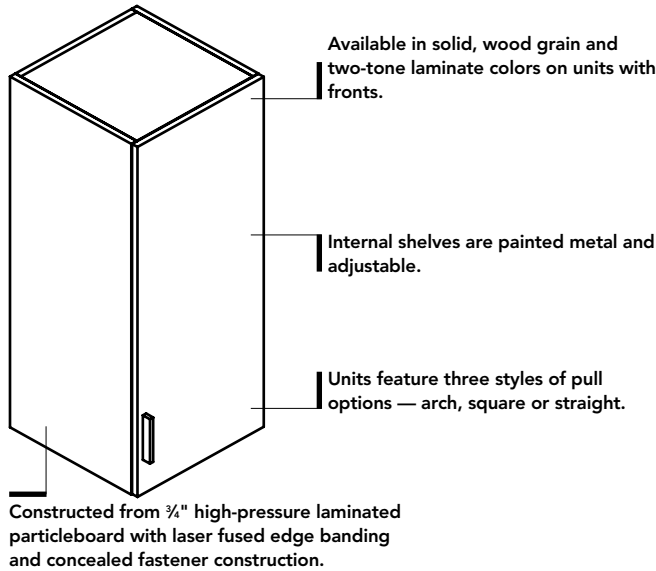

Overhead storage components maximize the use of space in the workstation and provide convenient access to binders, reference materials, software packages, and miscellaneous supplies. Overhead cabinets are available with sliding doors, hinged doors, open, and dual access with sliding door or open. Laminate selection includes solid color, woodgrain, or two-tone (case/doors).

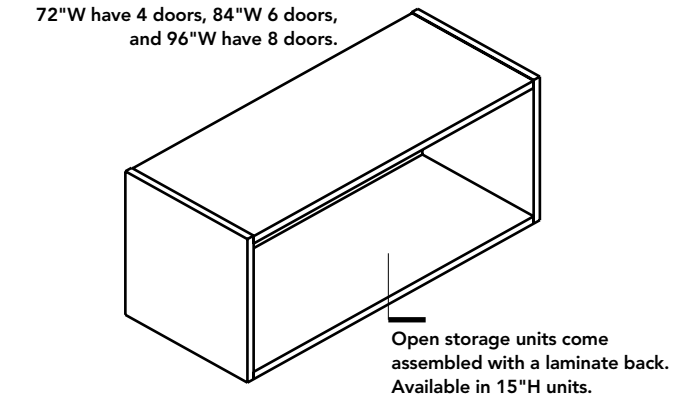
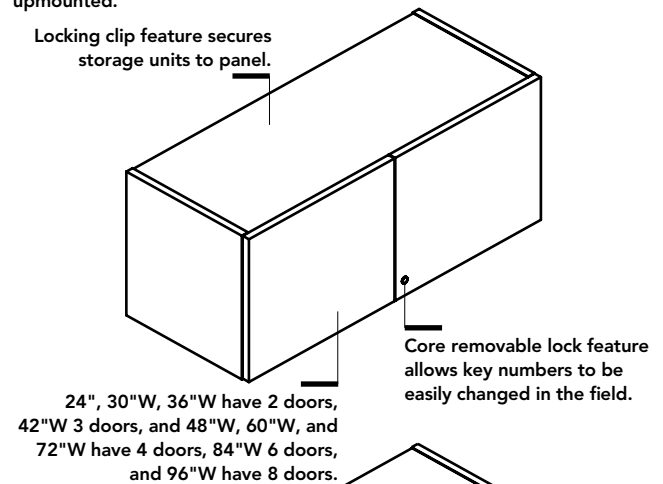
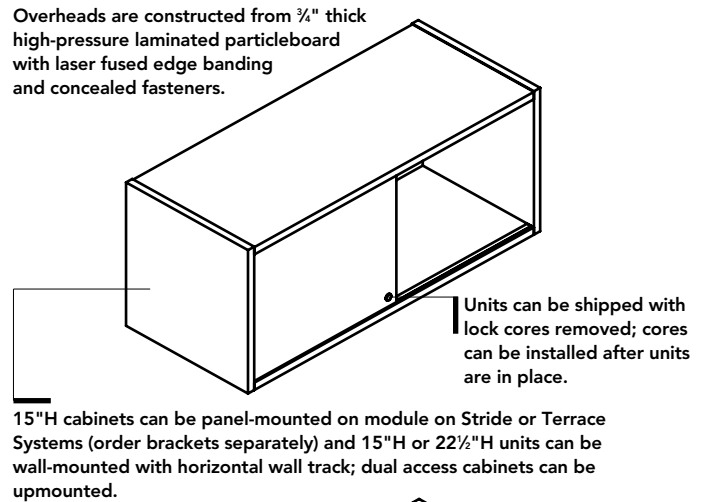

LED undercabinet light can be mounted beneath laminate overhead cabinets for a low profile lighting option. (Recessed tasklights not recommended as bottom of laminate wood storage is not recessed.)

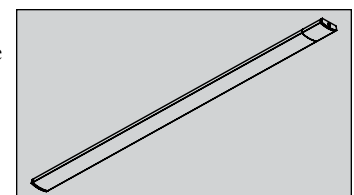

Product Dimensions

Stacking Storage

Width 18", 24"
 Inside Width 16 3/8", 22 3/8"
 Depth 18"
 Inside Depth 16 3/8"
 Actual Height 19 3/4", 27 1/4", 34 3/4", 42 1/4"
 Inside Height 18 1/4", 27 1/2", 33 3/4", 40 3/4"

Open Box

Width 24", 30", 36", 42", 48", 60"
 Inside Width 1 3/4" less than width
 Depth 15"
 Inside Depth 13 3/8"
 Height 15"
 Inside Height 13 3/8"

Overhead Storage Cabinet w/Doors

Width 24", 30", 36", 42", 48", 60", 72", 84", 96"
 Inside Width 1 3/4" less than width
 Depth 15"
 Inside Depth 12 7/8"
 Height 15", 22 1/2" (to 60"W)
 Inside Height 13 3/8", 20 7/8"

Overhead Storage — Dual Access

Slider Widths 36", 48", 60"
 Open Width 60", 72"
 Inside Width 17 1/8", 23 1/8", 29 1/8", 35 1/8" per side
 Depth 15"
 Inside Depth — Slider 15 1/4"
 Open 16 3/4"
 Height 15"
 Inside Height 13 3/8"

Wood Storage — Floor Based

- Plinth base or footed design with choice of feet that coordinate with either Stride® or Terrace®. (Unless unit is mobile.)
- Three pull options: arch, square, or straight.
- ¾" thick high-pressure laminated particle board with laser fused edge banding and European cam-and-pin construction.
- Available laminates: solid, woodgrain, or two-tone (case one laminate / front (door or drawer) a different laminate).
- 72"W units require Solid color laminate case, front can be woodgrain or solid.
- Doors and drawers lock except for stacking storage units and hinged cupboard doors on towers.
- Single sided sliding door units are non-handed; open half depends on door position. Door locks in either position.
- Some models require counterweights, wood backs, or ganging — see page 97.
- File drawers 30"W and wider accommodate legal size documents.

Mobile Pedestal (Plinth base or footed page 116)

- Box/file drawers; 24"H x 15½"W x 18"D.
- Has a top and finished back. Ships with counterweight.

Freestanding Pedestals (Plinth base or footed page 116)

- Box/file drawers; 24"H x 18"W x 18"D or 24"D.
- Have a top and unfinished back.
- Requires counterweight (order separately) if freestanding — see page 97.

Support Pedestals (Plinth base or footed page 116)

- Support pedestals include box/box/file, file/file, or open with one adjustable metal shelf.
- Support pedestals are 15½"W or 18"W; 18"D, 24"D and 30"D; and 28"H. They are meant to support worksurfaces; optional tops are available. With a top they are 29½"H.
- 30"D pedestals are designed to support 30"D worksurfaces; drawer depths are the same as 24"D pedestals.
- Open w/shelf models have finished laminate backs; backs on other models are unfinished with optional laminate back ordered separately if back is exposed.

17½"H Credenzas (Plinth base or footed page 117)

- 18"D or 24"D; includes tops. Some models require counterweights or ganging — see page 97.
- Single lateral has one drawer, 30"W or 36"W. Requires counterweights. Optional laminate back ordered separately.
- Single lateral w/open side cubby is handed — drawer, left, or right; 48"W, 60"W, or 72"W.
- Table (closed base) units are 24"W x 24"D.

24"H Credenzas (Plinth base or footed pages 118-119; Powered pages 152-153)

- 18"D or 24"D with tops.
- Box/lateral is 30"W and box/box/lateral is 36"W. Optional laminate back ordered separately.
- Box/lateral w/open side are handed — drawer, left, or right; 48"W, 60"W, or 72"W.
- Sliding door w/adjustable metal shelf; 36"W or 48"W.
- Open binder units have an adjustable metal shelf; 18"W, 24"W, 30"W, or 36"W.

28"H Support Credenzas (Plinth Base or footed pages 120-121;

Powered page 154)

- 18"D or 24"D without tops.
- Units are designed to support worksurfaces; tops must be ordered separately. With top, credenzas are 29½"H.
- Box/box/lateral are 24"W or 30"W. box/box/project drawer/ lateral is 36"W. Optional laminate back ordered separately.
- Lateral/laterals are 30"W or 36"W. May require counterweights — see page 19. Optional laminate back ordered separately.
- Sliding door units w/adjustable metal shelf and an open top shelf; non-handed, 36"W or 48"W.
- Open cubby models have an adjustable metal shelf; 24"W, 30"W, or 36"W.

42"H Credenzas (Plinth base or footed page 122)

- Units are 18"D and designed to support worksurfaces; tops must be ordered separately. With worksurface, credenzas are 43½"H.
- 3-drawer lateral has a laminate back with seams and is 36"W. Aesthetic should be considered in applications where back is visible.

Cam Cover Kits (page 125)

- 17½"H, 24"H, and 28"H credenzas ship without cam covers. Cam cover kits can be ordered separately. 20 cam covers in each kit.

Bookcases and Bookcases with Lateral File (Plinth base or footed page 123)

- Open bookcases are 15"D. 65"H have 2 adjustable and 1 fixed shelves. 72½"H have 2 adjustable and 2 fixed shelves.
- Bookcases w/lateral are 24"D with 15"D upper bookcase. 65"H have 2 fixed shelves. 72½"H have 1 fixed and 2 adjustable shelves.
- Pin-and-cam fasteners visible from the front are covered with cam covers.
- Backs of all units have exposed pin-and-cam fasteners. Optional cam covers are available to order. Aesthetic should be considered in applications where back is visible.

Tops and Cushions for Pedestals and Credenzas (page 124)

- Laminate tops are 1¼" thick and 18"D or 24"D, for use on storage without tops in freestanding applications. Certain freestanding applications require counterweights or ganging — see below.
- Cushions are for use on 17½"H and 24"H storage with tops to create additional seating.

Counterweight Kits (page 125)

- Counterweight is attached to the bottom of a credenza to inhibit tipping.
- Kits must be ordered separately (see page 125) based on type and depth of unit and field-installed.
- Units designated to be ganged must be ganged to at minimum a 36"W unit with non extendable elements (i.e. KL243618N).
- Counterweight kits required for freestanding pedestals and credenzas:

HEIGHT / WIDTH	DEPTH	REQUIRED KITS
24"H Pedestals		
18"W	18"D	2 Kits & Wood Back
	24"D	2 Kits*
	30"D	0 Kits
28"H Pedestals		
15"W or 18"W	18"D	2 Kits & Wood Back
	24"D	2 Kits
	30"D	0 Kits
17"H Single Lateral Credenzas		
30"W or 36"W	18"D	2 Kits & Ganged*
	24"D	0 Kits & Ganged
17"H Single Lateral w/Open Side Credenzas		
48"W, 60"W, or 72"W	18"D	1 Kit
	24"D	0 Kits
24"H Lateral w/Box Drawer(s) Credenzas		
30"W or 36"W	18"D	4 Kits & Ganged*
	24"D	4 Kits & Ganged*
24"H Lateral w/Open Side Credenzas		
48"W, 60"W, or 72"W	18"D	3 Kits
	24"D	0 Kits
28"H Lateral w/Box Drawers Credenzas		
24"W	18"D	2 Kits & Ganged*
	24"D	2 Kits & Ganged*
30"W or 36"W	18"D	4 Kits, Wood Back, & Ganged
	24"D	1 Kit & Ganged*
28"H Lateral/Lateral Credenzas		
30"W or 36"W	18"D	3 Kits & Wood Back
	24"D	3 Kits*

Units designated with an "" may have 1 counterweight kit removed if a finished wood back is installed.

- Counterweight kit(s) and/or wood backs are not required if ganged back-to-back.
- One counterweight kit can be removed for each additional 36" width of ganged storage to units with non extendable elements.
Example: (1) 28"H x 36"W x 24"D Lateral/Lateral Credenza
 + (2) 28"H x 36"W x 24"D Open Credenzas
 (3) kits - (2) kits for 72" ganged = (1) **total kit required**

Ganging Brackets (page 125)

- Ganging brackets attach to underside of Credenzas.
- Can be used in place of Counterweight Kits based on counterweight requirements above.
- Unique ganging bracket models for footed and plinth base models.

Metal Shelves (pages 126-127)

- Pullout shelves have a 50 lb. weight capacity and are field-installed using supplied template.
- Pullout shelves are 2"H x 18"W, 24"W, 30"W, or 36"W; and 12"D, 18"D or 24"D in Core, Select, and Accent paint colors.
- Pullout shelves can be used in open cubby space with box/lateral credenzas with septum (exception of sliding door credenzas with septum).
- Additional metal shelves with pins in dimensions for open units are available in Core, Select, and Accent paint colors.

Soft Seating — Bases/Tops/Cushions and Tables

(Plinth base or footed pages 128-129)

- Bases, either plinth base or leg base units, are ordered separately from seat cushions and table tops. 11"H x 24"D seat base comes with drawer(s) or open shelves; unfinished back and no top. 24"W, 36"W or 48"W.
- Order seat base top(s) 12"W, 24"W, 36"W, or 48"W; or 24"W seat base cushion(s); or banquette cushion(s) (24"W or 36"W) separately to fill entire width of seat base.
- 24"W seat base top is available with power module cutout. Power modules ordered separately with USB, iPod, or Ports.
- Seat base drawer fronts have finger pocket on underside.
- Low open table with top is 11"H and can be used in a soft seating application; 36"W or 48"W and 18"D or 24"D.
- Corner table w/top is closed on all sides; 17½"H x 24" x 24".
- When creating a 90° setup using three seat bases, use of ganging bracket replaces front visible foot on corner seat base.

Personal Towers (Plinth base or footed pages 130-134)

- Available in heights of 42½", 50", 57½", 65", and 72½".
- Available in right-hand and left-hand configurations. Box/box/file and file/file — front hinged door or side access models with or without 6" wide full-height wardrobe.
- 12"W towers must be attached to a panel, worksurface, or credenza.
- 18"W towers must be attached to a worksurface.
- Pilot holes in case to use "L" tower bracket or tower rail.
- Shelves in hinged door models are adjustable.
- Shelves in side access models are adjustable.
- Full width wardrobe 18"W or 24"W with 2 adjustable metal shelves on 65"H or 72½"H. 24"D have hanging rod; 18"D have double-hook.
- Pin-and-cam fasteners visible from the front and behind a door are covered with cam covers.

"L" Tower Bracket (page 134)

- Used to support a worksurface at 29½"H.
- Attaches using pre-drilled holes inside the tower.
- For use with laminate and painted wood storage only.
- The depth of the worksurface and tower should be equal.

Tower Rail (page 134)

- The tower rail mounts to the user side of towers and is used to attach worksurfaces at a height range of 27½"H to 30½"H.
- Attaches using pre-drilled holes inside the tower.
- Requires rail bracket kit for worksurface — order separately.

Stacking Storage (page 135)

- Units are 18" deep; 20", 27½", 35", and 42½"H. Open units 18"W or 24"W and hinged door units 18"W. 24"W hinged door with 6"W side display available 20"H or 27½"H.
- Units are non-locking and designed to be attached with double-sided tape on top of a 28"H properly supported storage unit worksurface and align with Stride®, Terrace® or Optimize™ elevations.
- Stacking Storage units can not be stacked on each other.
- 42½"H units have two adjustable-height metal shelves; 27½"H and 35"H units have one adjustable shelf.
- Pin-and-cam fasteners visible from the front and behind a door are covered with cam covers.

Overhead Storage (pages 135-137)

- Units include: hinged door, sliding door, dual-access, and open.
- 15"H units are designed to mount on module to a panel (Terrace or Stride — order panel mount brackets separately) or mount atop stanchions — ordered separately. 15"H and 22½"H units mount to a hard wall using horizontal wall-mount bracket — ordered separately. 22½"H have fixed metal shelf and can only be wall mounted. *See page 93 for panel mounting rules.*
- No double stacking of laminate overheads.
- 24"-36"W hinged door cabinets have 2 doors with one lock on the front of the cabinet; 42"W 3 doors with two locks; 48"W, 60"W, and 72"W have 4 doors with a center security septum and two locks; 84"W 6 doors, two septums, and three locks; 96"W 8 doors, three septums, and four locks.
- Sliding door overheads have one door with one lock that can only be locked when the door is in the left-hand position.
- Back side of single sided units are not meant to be exposed.
- Dual-access units are 18"D and designed to be used between two stations with Terrace panel system. Open units are 36"W, 48"W or 60"W; sliding door units 60"W or 72"W lock.
- Overhead cabinets feature self-engaging safety latch to secure the cabinet to panel.
- Specify low profile LED tasklights. *See page 138.*
- Pin-and-cam fasteners visible from the front, bottom, and behind a door are covered with cam covers.
- Overheads 72"W or greater cannot be panel mounted. For stanchion mounting and wall mounting only.
- When stanchion mounting 72"W or greater overheads, a taskpanel kit is required on one or both sides.
- A mid stanchion is required with overheads 72"W and wider.
- A taskpanel kit is required when attaching 72"W and wider overheads to a single adjacent tower using the tower-to-overhead bracket kit.
- Taskpanel kits are not required when attaching 72"W and wider overheads to two towers using the tower-to-overhead bracket kits.
- When wall mounting overheads 72"W and wider use two brackets: 2-36"W for 72"W, 2-42"W for 84"W, and 2-48"W for 96"W.
- When ordering a two-tone option for overheads 72"W or greater, the case must always be a solid laminate color.
- Woodgrain laminate option limited to doors for overheads 72"W or greater. Case must be a solid laminate color.

Laminate Shelf, Book Shelf, and Open Box (page 137)

- Units are designed to mount on module to a panel (Terrace® or Stride® — brackets provided).
- Cannot be wall-mounted.
- Ship with panel mount brackets installed.
- Capacity not to exceed 50 lbs. on laminate shelf.

Overhead Stanchions (page 138)

- Aluminum, mid, and non-handed; 5", 11", 12", 18", 19¼", 26", and 27"H.
- 15"D used with single sided overheads, 18"D with dual access.
- Stanchions for 24"H credenzas with tops aligns unit with panel or storage: 11" stanchions align with 35"H; 18"H aligns with 42½"H; 26" aligns with 50"H.
- Stanchions for 28"H credenzas on 29½"H surface aligns unit with panel or storage: 5" stanchions align with 50"H; 12"H aligns with 57½"H; 19¼" aligns with 65"H; 27"H aligns with 72½"H.
- Overheads 72"W and wider require a mid overhead stanchion.
- Unfinished back may be exposed in freestanding application.
- Overhead stanchions are not recommended to be used on freestanding desks.

Tower-to-Overhead Bracket (page 138)

- Used when stanchion mounting 72"W, 84"W, or 96"W overheads to an adjacent tower.

Horizontal Wall-Mount Brackets (page 138)

- Use to attach an overhead directly to wall.
- Attachment hardware not included.

LED Undercabinet Light (page 138)

- Low profile energy-efficient LED tasklight for use with Involve overhead storage cabinets. Attachment hardware included.
- 95 footcandles at 18"; 3500K color temperature.
- 15W power supply is attached to plug: allow 1⅞"D space at outlet. Includes 3 cord retainer clips.

Hutches (page 140)

- Units include: hinged door, sliding door, and open.
- Designed for use on top of 28"H credenzas with a worksurface of same or greater width — 35"H align with 65"H and 42½"H with 72½"H elevation.
- Laminate hutches are not recommended to be used on freestanding open gable desks.
- Laminate hutches ship fully assembled and attach to a worksurface with double sided tape.
- When ordering a two-tone hutch with a woodgrain case 66"W and wider, the woodgrain direction on the lower back runs horizontal (tackboard recommended). The upper back woodgrain runs in a vertical direction.
- 48"-72"W hinged door cabinets have 4 doors with two locks on the front of the cabinet and a center security septum, 84"W has 6 doors with three locks and two security septums.
- 48"-66"W sliding door overheads have one door with one lock. 72" and 84"W have 2 doors with two locks and two security septums. Doors can only be locked when the door is in the left-hand position.
- 35"H have 19¼" of clearance and 42½"H have 27¼".
- Specify low profile LED task lights.
- Pin-and-cam fasteners visible from the front, bottom, and behind a door are covered with cam covers.

Tackboards for Hutches (page 141)

- Use tackboards to finish the back of a hutch.
- Tackboards are recommended on woodgrain laminate hutches since woodgrain runs horizontal as opposed to vertical.
- Specify paint color for metal frame and panel fabric.
- 66"W, 72"W, and 84"W ship as two tackboards and a center splicer for routing cables.

Primary Center Grommet Worksurfaces for use with Hutches (pages 142 and 144)

- For use with Involve laminate hutches (72"W and 84"W) when a grommet or scallop is needed in the center of the worksurface which the hutch is sitting on.
- Rectangular only, in 72"W and 84"W — laminate with flat or rabbet edge and veneer with square or rabbet edge.
- Always includes center grommet position; left, right, or left and right additional grommet positions are optional.
- Oval plastic grommets are standard; metal grommet(s) are optional.

Involve® Worksurfaces

Working with Worksurfaces and Supports

GSA Reference Page

Laminate worksurfaces are 1/4" thick with particle board core and with top surfaces finished in high-pressure laminate. Bottom surfaces are covered with a backer sheet.

Expanded worksurface offering including linear taper and the new sweep shaped worksurfaces to support the integration of Involve soft seating and 18"D storage into the workplace.

Wire management grommets are standard in most worksurfaces (unless specified without grommets).

Support Guidelines

- Unsupported panel runs greater than 72" need floor support for improved stability.
- Worksurface bracket kit should be used to tie panels to worksurface for added stability.
- A panel run without a return needs a floor support.

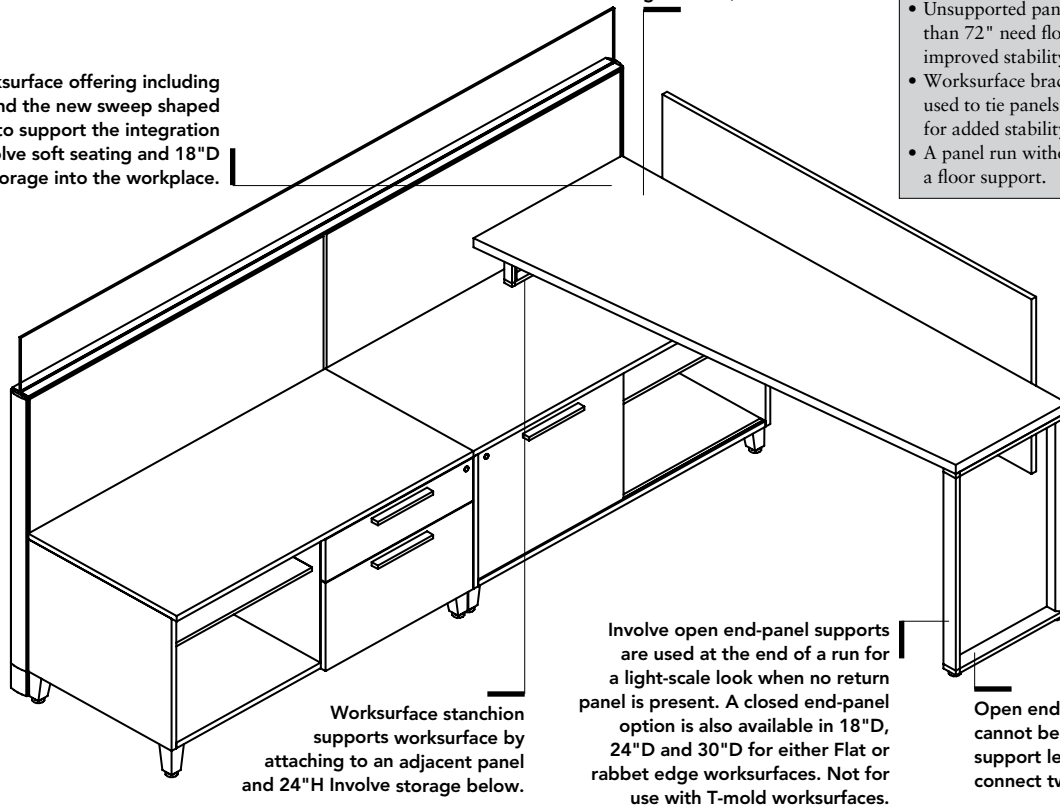

Worksurface stanchion supports worksurface by attaching to an adjacent panel and 24"H Involve storage below.

Involve open end-panel supports are used at the end of a run for a light-scale look when no return panel is present. A closed end-panel option is also available in 18"D, 24"D and 30"D for either Flat or rabbet edge worksurfaces. Not for use with T-mold worksurfaces.

Open end-panel supports cannot be used as inline support leg, or used to connect two worksurfaces.

Primary worksurfaces are available in 18", 24", and 30" depths. Nominal worksurface width is equal to nominal panel width. Unsupported worksurface spans of 60"W-84"W require an external worksurface support channel. It is recommended for spans 48"W-59"W. See pages 103 and 147. Support hardware is ordered separately.

Corner worksurfaces with woodgrain laminate and veneer have grain direction diagonal to adjacent worksurfaces. One rear center support bracket is included. All other support hardware is ordered separately.

Secondary worksurfaces are available in 12", 18", and 24" depths. Support hardware is ordered separately.

Credenza and pedestal tops are specified separately for 28"H and 42"H units to allow the spanning of multiple peds or credenzas.

Threaded-metal inserts are standard for ease of installation and a positive fit. Worksurfaces can be panel hung or used in freestanding applications.

Worksurface stanchions are used to support worksurface when mounted atop a 24" high Involve credenza. Worksurface stanchions are 5/4"H and made of aluminum. They are available in depths of 12" and 18" and used to support surfaces 18", 24", and 30" deep.

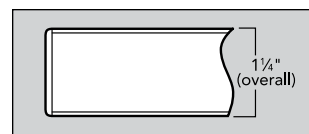

Flat Edge trim is available on laminate tops in eleven standard colors (customer specified) to match solid laminates and to complement patterned or in fourteen woodgrain edges color matched to the woodgrain laminates. Veneer worksurfaces have veneer edge.

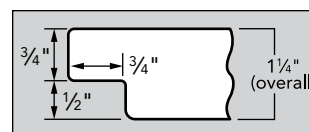

Rabbet Edge trim is available on select laminate and veneer tops. These worksurfaces and credenza tops have rabbet edge detail on all sides.

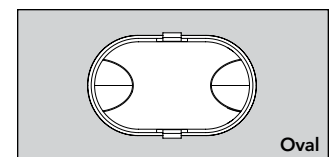

Oval

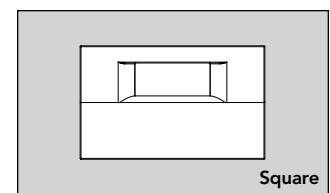

Square

Wire management grommets are standard in most worksurfaces and are specified in plastic or metal. **Metal grommets** are available in oval or square (shown above).

Primary and Linear Taper Worksurfaces (pages 142-145)

- Wire management grommets standard, one for widths up to 36", two on widths 42"W and greater. Add "N" suffix for no grommets.
- Worksurfaces 66" and over require a cantilever bracket for center support in panel mounted applications. Specify 18" cantilever on 24"D, and 24" cantilever on 30"D worksurfaces.
- Desking worksurfaces should be specified for spans 60" and over when worksurfaces are not panel-attached with additional support along the width. For desking applications and widths greater than 72", additional to-the-floor support is recommended.
- Laminate flat edge worksurfaces can be specified with scallop wire management detail with no upcharge by adding suffix "S" to the model number.

Primary Desking Worksurfaces (pages 142-145)

- Ships with an external worksurface support channel which extends 1½" below the worksurface and is inset 6" from each end. Support channel is field installed to allow for larger worksurface spans and ships separately.
- Wire management grommets standard, one for widths up to 36", two on widths 42"W and greater. Add "N" suffix for no grommets.
- Laminate flat edge worksurfaces can be specified with scallop wire management detail with no upcharge by adding suffix "S" to the model number.

EZ View Transition Worksurfaces (pages 142 and 144)

- Surface is non-handed, with one wire management grommet centered on the 36"D end. Add "N" suffix for no grommets.

External Worksurface Support Channel (page 147)

- Extends 1½" below the worksurface.
- Is required on a systems worksurface for additional support for spans greater than 60"; or if a full depth horizontal storage unit is installed under the worksurface.
- Required when mounting a Stride® modesty panel.
- When using Involve supports, specify a standard worksurface and an external support channel of a smaller size. The size of the external support channel will depend on the distance between supports.

Freestanding Open End Panel Supports — Metal (page 146)

- Available 29½"H and 18"D, 24"D and 30"D. Non-Handed.
- Order according to type of worksurface (flat/square or rabbet edge) the end panel leg will support.
- When using an open end support with a tapered worksurface, either position the same depth end support on the narrow end of the worksurface or use a smaller depth support on the wide end to avoid the support extending beyond the edge of the tapering surface.
- May not be used to build a freestanding table.
- Adjustable glides have a leveling range of 2¾".

Panel-Mounted Open End Panel Supports — Metal (page 146)

- Available 29½"H and 18"D, 24"D and 30"D. Handed.
- Handedness is determined by position relative to the user. Specify a left hand leg to be on the user's left hand side, specify a right hand leg to be on the user's right hand side.
- Order according to type of worksurface (flat/square or rabbet edge) the end panel leg will support.
- When using an open end support with a tapered worksurface, it is recommended to position the end support on the narrow end of the worksurface.
- Adjustable glides have a leveling range of 2¾".

Freestanding Closed End Panel Supports — Laminate (page 146)

- Available 29½"H and 18"D, 24"D and 30"D. Non-handed.
- Can be used to build a freestanding desk or console table if specified with a full height modesty panel. See chart on page 148.
- Can not be used with rabbet edge worksurfaces.
- Includes laminate end-panel, attaching hardware and adjustable glides.
- Adjustable glides have a leveling range of 2¾".

Panel-Mounted Closed End Panel Supports — Laminate (page 146)

- Available 29½"H and 18"D, 24"D and 30"D. Non-handed.
- Can not be used with rabbet edge worksurfaces.
- May not be used to build a freestanding table.
- Includes laminate end-panel, panel mount bracket (non-handed), attaching hardware and adjustable glides.
- Adjustable glides have a leveling range of 2¾".
- Includes hardware to convert freestanding end-panel to panel mount. 24"H or 30"H and left- or right-handed.

Storage-to-Panel Brackets (page 146)

- Used to match the back or side of storage to a panel frame to provide stability when used with Stride or Terrace frames.
- Handedness is determined by side of storage that attaches to panel when facing panel run.

Post Leg (page 147)

- Used to support worksurfaces at 29½"H.
- Adjustable glides have a leveling range of 2¾".

Worksurface Stanchion (page 147)

- Worksurface stanchions are 5¼"H for Involve credenza and made of aluminum.
- Used to support worksurface when mounted atop a 24"H Involve credenza. (4"H designed for 22"H Stride credenza.)
- Stanchions are field located on 24"H storage, either centered or offset 3" from edge to create additional piling space between storage and worksurface.
- Available in depths of 12" and 18". 12" is designed to work with 18"D worksurfaces and 18" with 24"D worksurfaces. Use two stanchions when mounting a 30"D or deeper worksurface. Stanchion orientation should run parallel to the length of the worksurface it is supporting.

"L" Tower Bracket (page 134)

- Used to support a worksurface at 29½"H.
- Attaches using pre-drilled holes inside the tower.
- For use with laminate and painted wood storage only.
- The depth of the worksurface and tower should be equal.

Tower Rail (page 134)

- The tower rail mounts to the user side of towers and is used to attach worksurfaces at a height range of 27½"H to 30½"H.
- Attaches using pre-drilled holes inside the Tower.
- Requires rail bracket kit for worksurface — order separately.

Light-scale screens provide space division. There are four options available: surface mounted modesties, privacy panels, divider panels, and taskpanels.

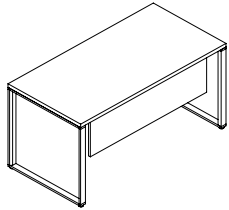

Surface mounted modesties are mounted to the underside of the desking worksurface or worksurface with external support channel. They are 11"H and available in laminate or frosted glass. Single or shared (laminate only) mounting models are available. Laminate models include a wire tray on one side of single units and on both sides of shared models. There is an optional wire tray available for glass units.

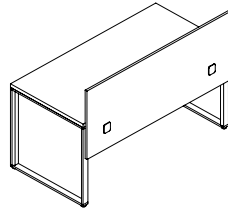

Privacy panels extend above and below the desking worksurface acting as both a screen and a modesty panel. They are 25"H and available in laminate or glass (frosted or writeable). Single or shared (laminate only) mounting models are available. Laminate models include a wire tray on one side of single units and on both sides of shared models. There is an optional wire tray available for glass units.

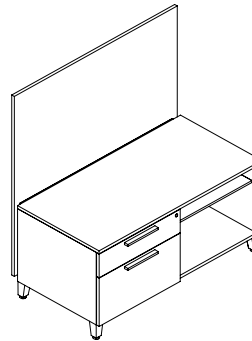

Divider panels attach to laminate back of credenza to provide space division between workstations. They are available in laminate in heights of 42½" and 50".

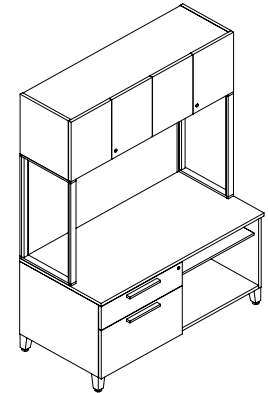

Taskpanels mount between stanchions under overhead storage cabinets. They are available as tackable, marker board, or laminate in 12", 18", 19", 26", or 27" heights.

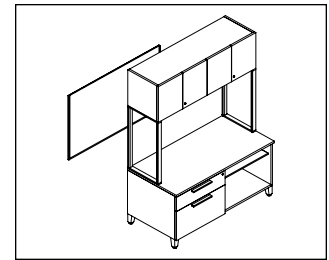
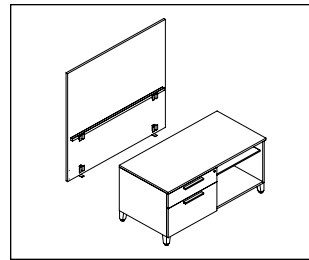

Specification Rules for Modesties and Privacy Panels

When mounting a modesty panel or a privacy panel use a desking worksurface or worksurface with an external support channel added. When mounting a modesty flush to the edge of a worksurface to 7" in from the front edge, the modesty must be 14" narrower than worksurface width.

When using a power/data module between a privacy panel and a worksurface, the privacy panel must be mounted 1" away from edge of the worksurface. Privacy panel can be mounted flush to the edge of the worksurface if power/data module is not used.

When using a power/data module with a surface mounted modesty panel, the

modesty panel must be inset a minimum of 2" in from the edge of the worksurface.

Privacy panel width can be same width as worksurface. *Example:* 60"W privacy panel can be used on a 30"D x 60"W worksurface. Width of panel is undersized by ¼" providing a ⅛" gap when centered. Placement or use of a modesty must be 12" narrower than worksurface width when using Involve open and closed gable ends.

When using modesty with a Stride post leg, the width of the modesty can be the same as the worksurface, but must be mounted 8" or more in from the front edge of the worksurface.

Freestanding Table Applications:

Privacy panels require a minimum worksurface depth of 30" for freestanding applications. Surface mounted modesties can be used with any depth freestanding application.

Panel Applications:

When using a privacy panel in a back-to-back application the adjacent panel run requires an extended straight connector to compensate for depth of shared privacy panel.

Full-Height Modesty Panels (page 148)

- Full height modesty panels are designed to create a desk. A desk can be created with a modesty panel, worksurface, and storage or gable ends on each side — see chart on page 146.
- Available in solid and woodgrain laminate color options. Modesties 61" wide or larger are limited to solid laminate colors only.
- It is recommended to recess the modesty in from the edge of the worksurface. When using with a 24"D surface, recess modesty 6". When using a 30"D surface, recess modesty 6" or 12".
- If attaching desk to a panel on one side, use a storage-to-panel bracket kit.

Surface Mounted Modesties (page 149)

- Laminate and glass models available for single use only.
- Surface mounted modesties mount to underside of surface to provide privacy below worksurface height.
- Surface mounted modesties are 11" high and ¼" thick laminate or ⅜" thick frosted glass.
- Single modesties mount on a single worksurface with two brackets. Laminate models have a single wire tray.
- When a laminate surface mounted modesty is specified under a worksurface supported on one end with an open or closed gable end support, the width of the laminate modesty should be a minimum of 3" shorter than the worksurface.
- When a surface mounted modesty panel is installed under a table with gable end legs on both sides, the modesty must be 12" narrower than the table.
- Glass modesties must always be 12" narrower than worksurface. When mounting a glass modesty to a worksurface the modesty must be centered.
- When using a glass modesty underneath a worksurface with electrical grommet cutouts on both corners, the modesty must be inset at least 8 inches from the front edge of the worksurface.

Privacy Panels (page 150)

- Laminate and glass models available for single use only.
- Privacy panels mount to the back side of worksurface(s) and extend above and below the worksurface(s) acting as both a screen and a modesty panel.
- Privacy panels are 25"H and ¼" thick laminate or ⅜" thick glass (frosted or writable).
- Single privacy panels mount on a single worksurface with two brackets. Laminate models have a single wire tray.
- Inset mounting bracket design provides mounting room for legs or open end panel support allowing the width of laminate privacy panels to match width of worksurface.
- Glass screen do not ship with wire channel. If wire channel is needed, use Stride® desking wire channel.
- Glass privacy panels must always be 12" narrower than worksurface. When mounting a glass privacy panel to a worksurface the modesty must be centered.
- When using a worksurface with electrical grommet cutouts the corner of the mounting bracket will be slightly visible from opening of the grommet.

Divider Panels (page 150)

- Divider panels can be attached to the back of 24"H credenzas to provide space division between workstations.
- Offered in laminate in widths to attach to 30"W, 36"W, 48"W, and 60"W plinth base credenzas; and heights to align with 42½"H and 50"H modules.
- Mounting brackets provide a 1" cord drop space between edge of worksurface and the ¾" thick divider panel.
- A cableway is provided on the inside of the divider panel to facilitate the passage of wires.
- Mounting brackets and cableway are available in black only.
- The mounting of the divider panel is designed to center the ¾" thick panel within the lateral space created by adding an extended straight connector in a panel spine.
- When specifying a divider panel to be attached to a credenza with an unfinished back, a laminate credenza back must also be specified for attachment of the divider panel brackets.
- Divider panel cannot span two credenzas side-to-side.
- Divider panels are designed to be used in single-sided application.
- Divider panel lines up with bottom of credenza case.
- Counterweight kits are still required in credenzas as rules state on page 99.

Taskpanels (pages 151-153)

- Taskpanels are available in laminate, marker board, or tackable material and attach between stanchions supporting an overhead storage cabinet.
- Taskpanels are available in 30"W, 36"W, 42"W, 48"W, 60"W, 72"W, 84"W, and 96"W. 72"W and wider consist of two panels. Nominal width of taskpanel should match width of overhead storage cabinet.
- Taskpanels are available 18"H or 26"H for use with 24"H credenzas; and 12"H, 19"H, or 27"H for use with 28"H credenzas. Nominal height of taskpanel should match stanchion height.
- Laminate and tackable taskpanels are encapsulated in a painted metal pan on sides and bottom.
- Back of unit has exposed fasteners. Aesthetic should be considered in applications where back is visible.

Routing Power & Data in Involve Footed Powered Credenzas

Involve powered credenzas are only available with a select offering of footed credenzas; powered plinth base units are not available. All powered units ship without a laminate back. The 8-wire electrical system is a UL 1286 and UL 183 listed electrical system. The removable internal back provides easy access from the front of credenza to power and data cords. In addition to the standard electrical components, PVC-free components are also available.

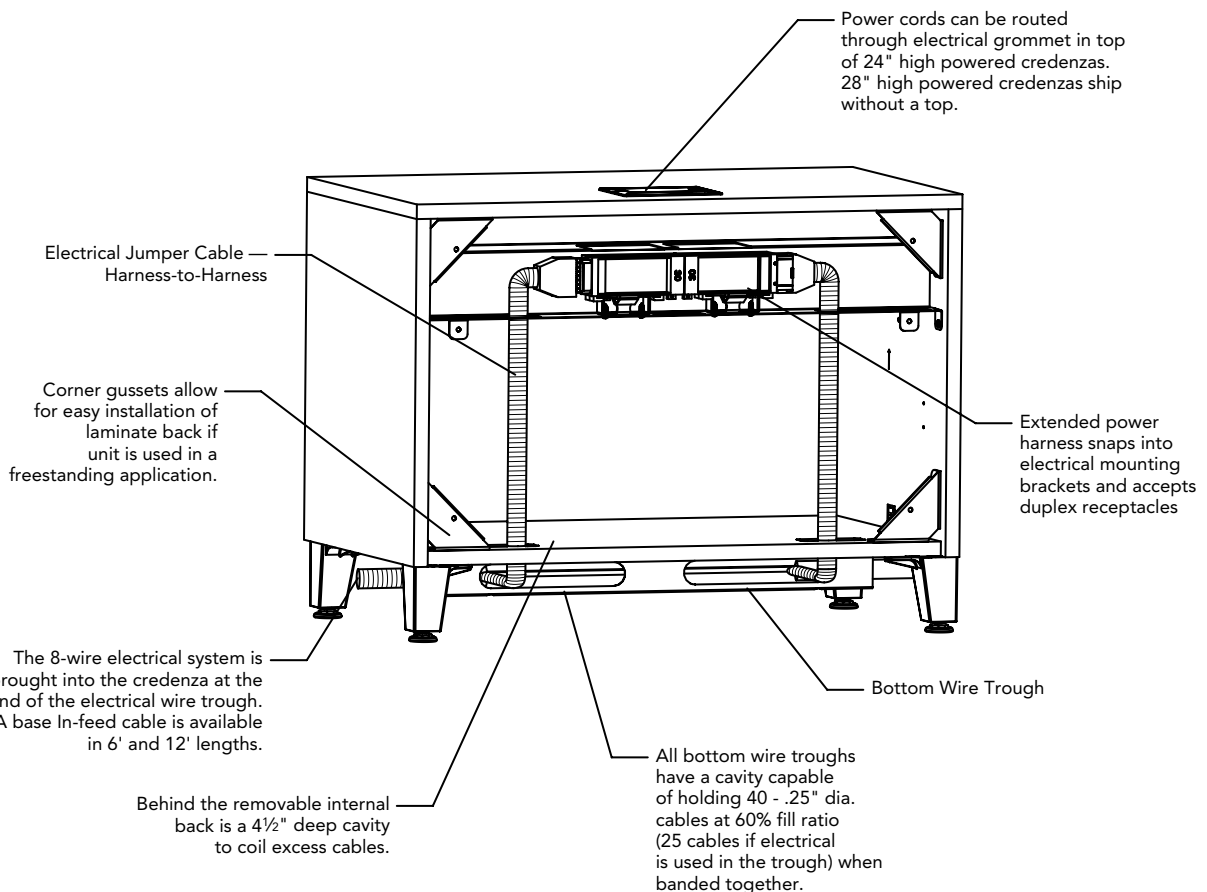
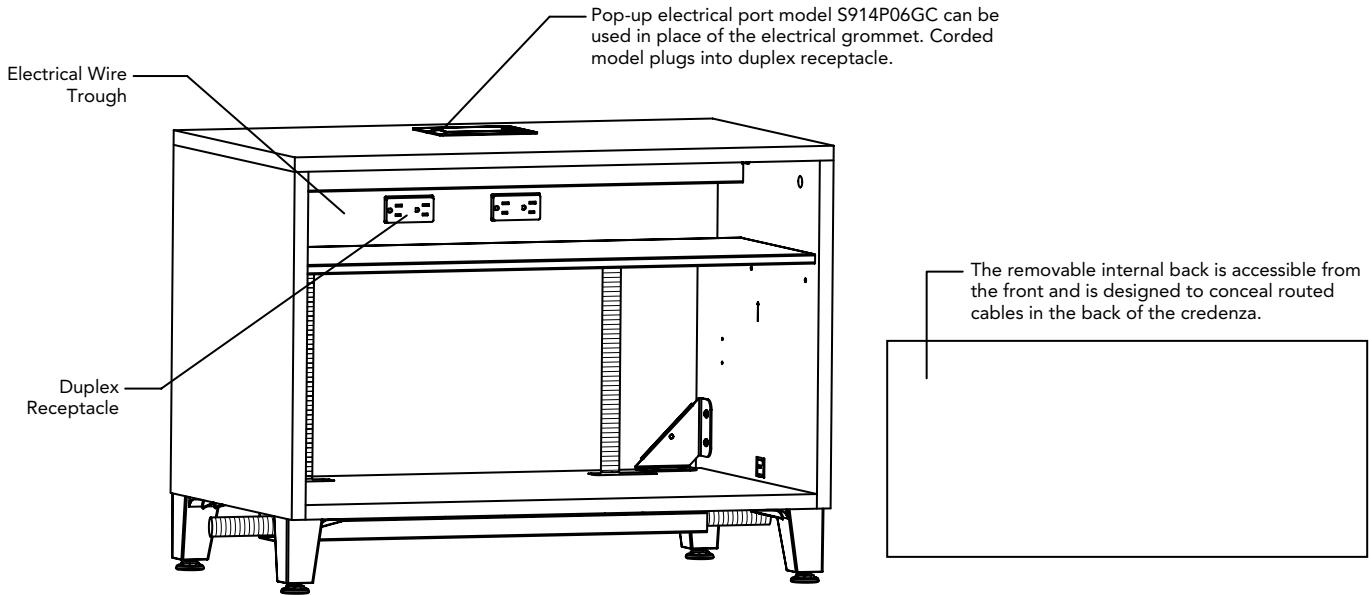

SPECIFICATION INFORMATION

This electrical system offers three options: four circuit, 3+1; four circuit, 2+2; and three circuit, separate neutrals. All three systems utilize an 8-wire electrical system, rated at 20 amps (15 amps Canadian). Connect a maximum of 13 receptacles (12 in Canada, and fewer in certain U.S. locales) to one circuit. Consult your electrician to ensure the planned electrical load is within permissible limits.

1. Determine which electrical system you will use after consulting with your electrician and computer support personnel (see pages 316-317):
 - The four circuit system (4-Hot/2-Neutral/2-Ground)
 - 3 + 1 option
 - 2 + 2 option
 - The three circuit system (3-Hot/3-Neutral/2-Ground)

2. Determine location, quantity, and circuit number for duplex receptacles and power entry.
3. Determine the appropriate choice and use of isolated, isolated/dedicated and separate neutral circuits
4. Specify appropriate extended power harness and jumpers.
5. Determine the location, quantity and type of power in-feed needed.

It is the customer's responsibility to ensure that the installation of the electrical components meets all local and national building codes and all other applicable regulations.

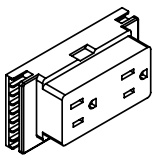

Duplex Receptacle

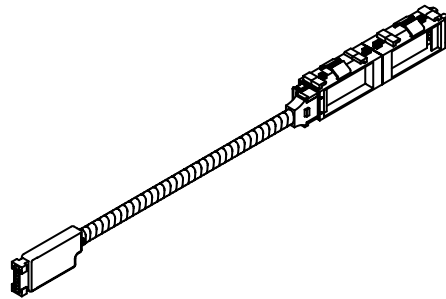

Extended Power Harness

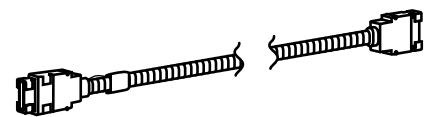

Jumper Cable
Harness to Harness

A. Routing Electrical Within a Powered Credenza

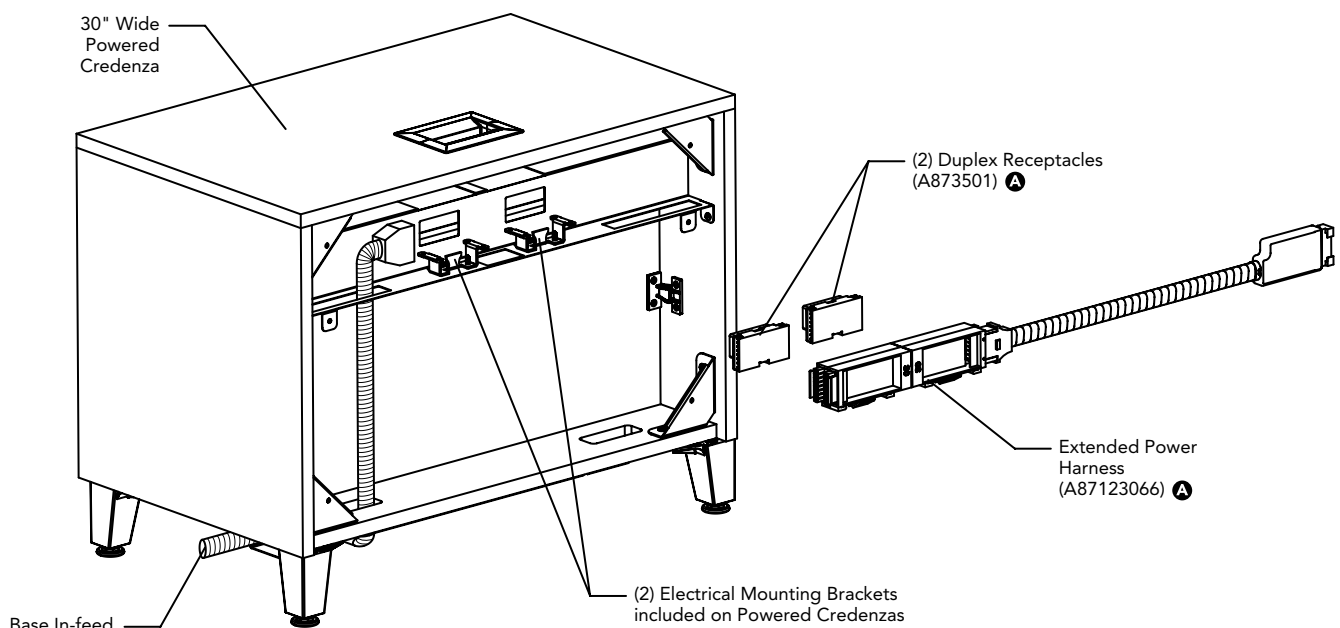

Ⓐ "A" prefix added to old model number effective 8/3/2014.

B. Routing Electrical in Powered Credenzas Back-to-Back

All electrical components must be duplicated in a back-to-back application. The wire trough provides power to only one side of the credenza.

When routing electrical from the back side of one to the back side of another, use the following extended power harness:

- 24" High Credenzas = 66" W (87123066)
- 28" High Credenzas = 78" W (closest available model 87123084)

An electrified credenza wire trough has a cavity capable of holding 40 - .25" dia. cables at 60% fill ratio (25 cables if electrical is used in the rail) when banded together.

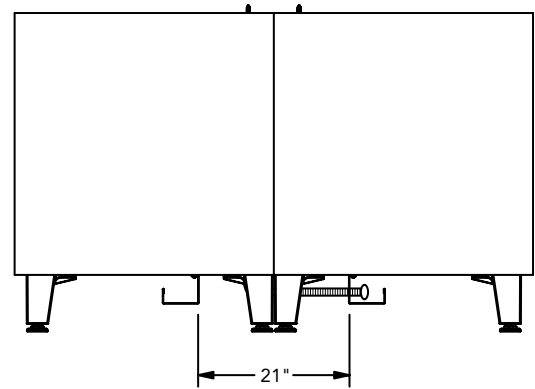
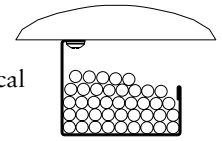

Note: Tops removed for clarity.

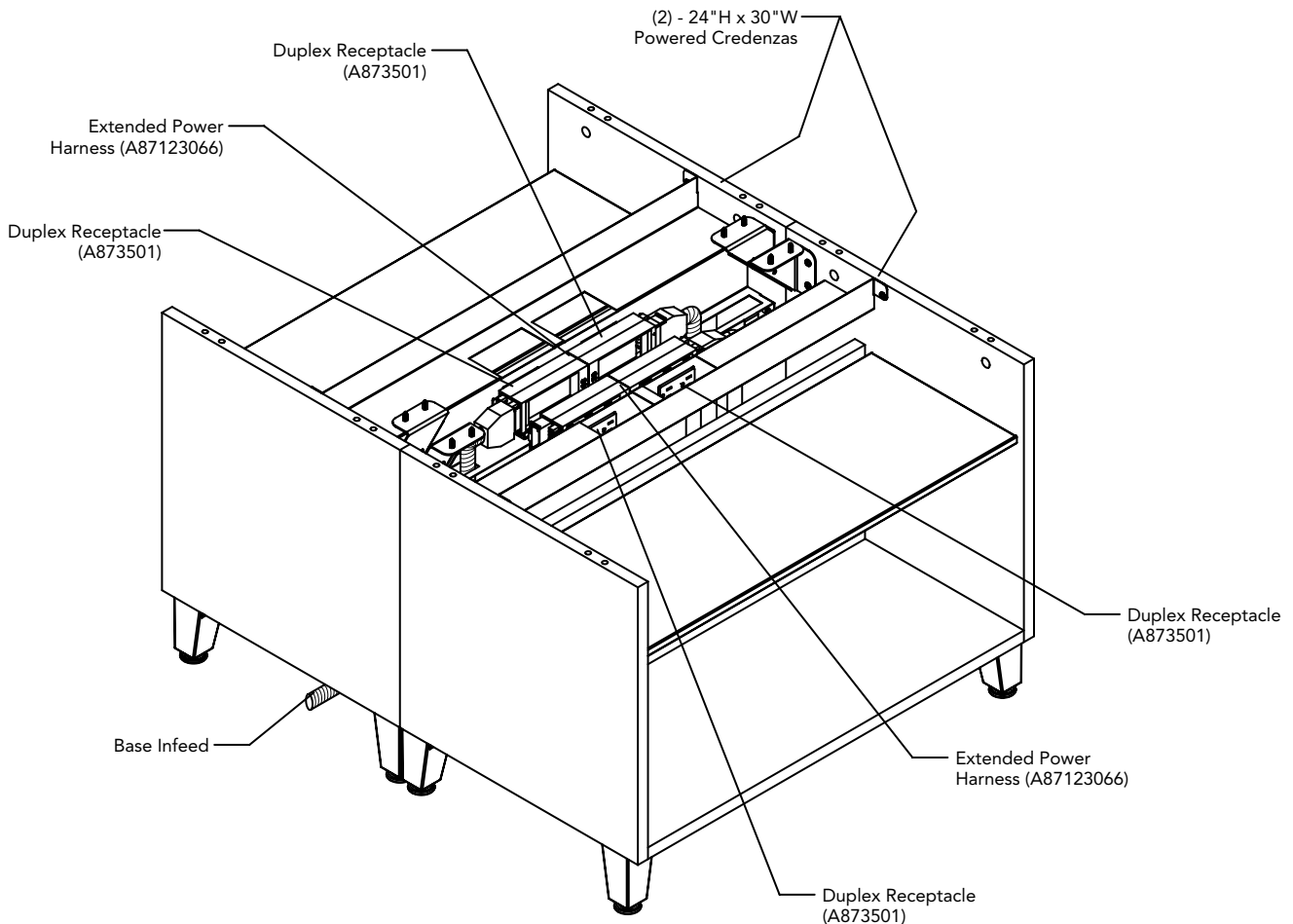

ALIGN METAL SPEC
ALIGN PRICING
ESSENTIALS SPEC
ESSENTIALS PRICING
VERTICALS
INVOLVE SPEC
INVOLVE PRICING
ALIGN VENEER

C. Routing Electrical Within Powered Credenzas Side-to-Side (Open/Sliding Door Models)

When routing electrical in side-to-side credenza application, use the following extended power harness:

- 24" High to 24"High Credenzas = 66"W (87123066)
- 28" High to 28"High Credenzas = 78"W (closest available model 87123084)

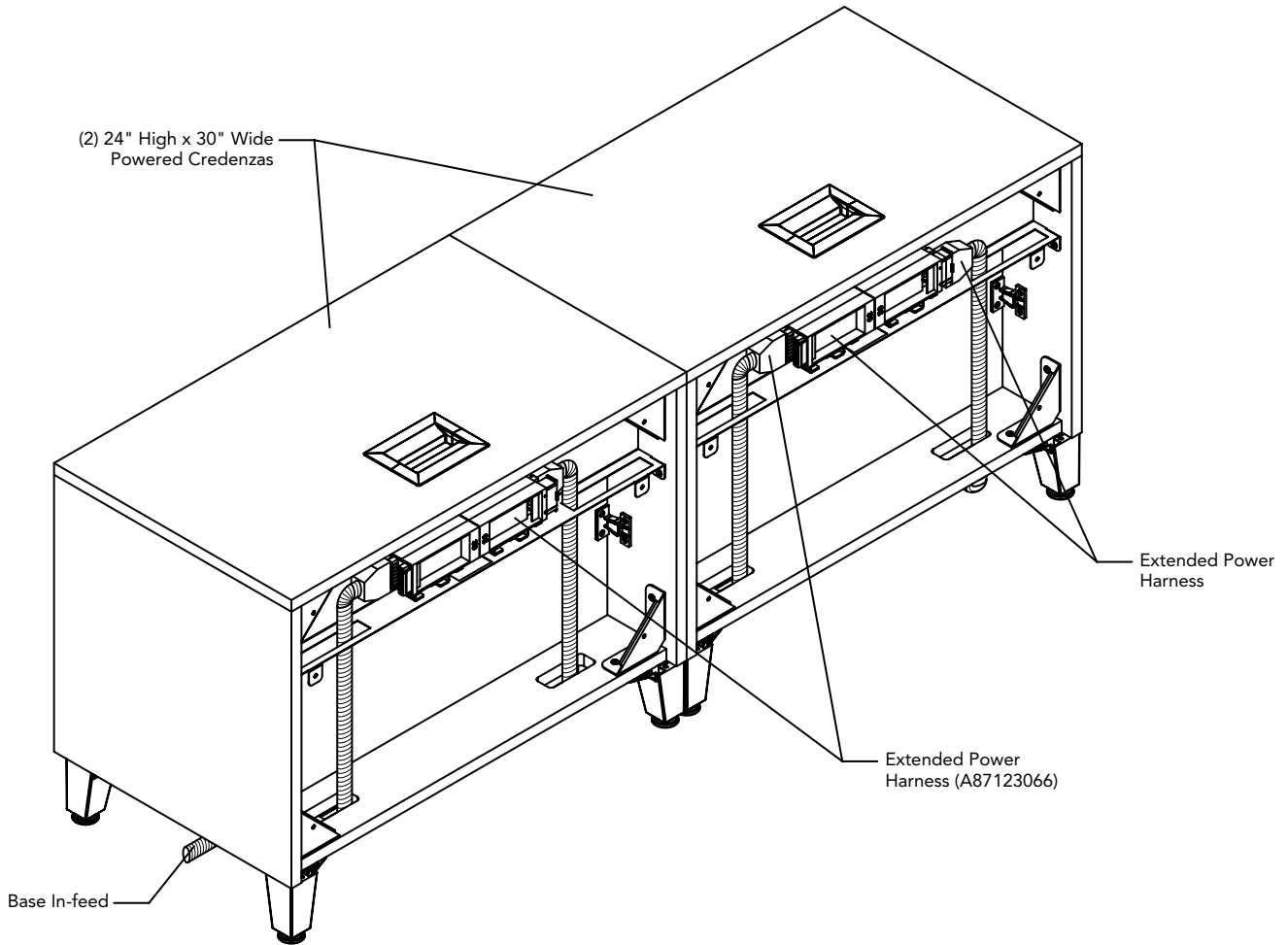

D. Routing Electrical To Span a Non-Powered Credenza

- When routing electrical in a spanning credenza application, add width of the credenza being spanned to side-to-side credenza extended power harness length.
- Appropriate width bottom wire trough model must be ordered for non-electrified credenza being spanned in the field.

24" High Units — Extended Power Harness =
66" + 24" = 90" (closest available model 87123096)

28" High Units — Extended Power Harness =
78" + 24" = 102" (closest available model 871230120)

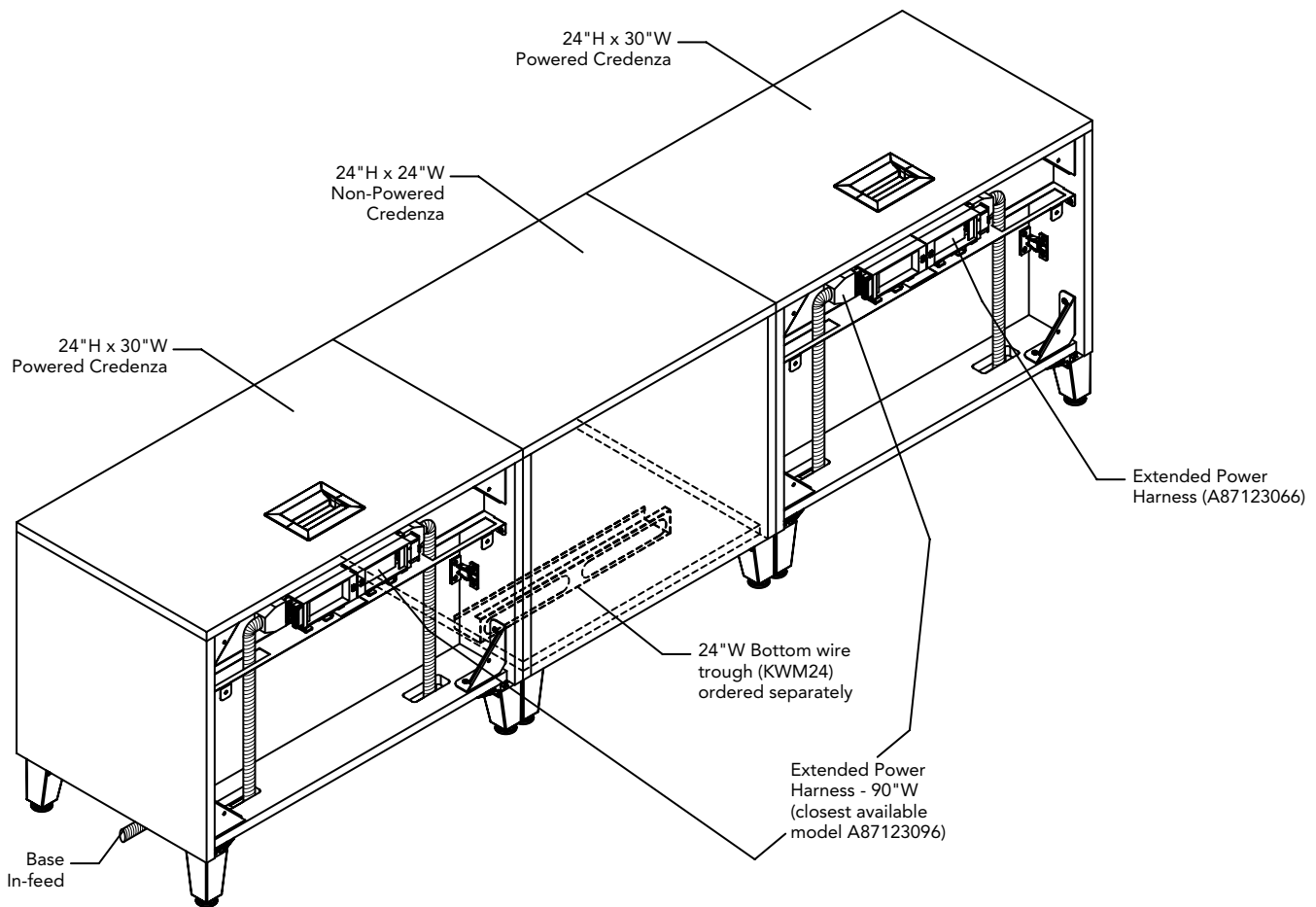

E. Routing Electrical in Lateral/Open Combination Powered Credenzas

- When routing electrical in a combination credenza application, add credenza drawer width to side-to-side credenza extended power harness length.

24" High Units — Pass Thru Power Harness =
66" + 24" = 90" (closest available model A871196)

28" High Units — Pass Thru Power Harness =
78" + 24" = 102" (closest available model A871120)

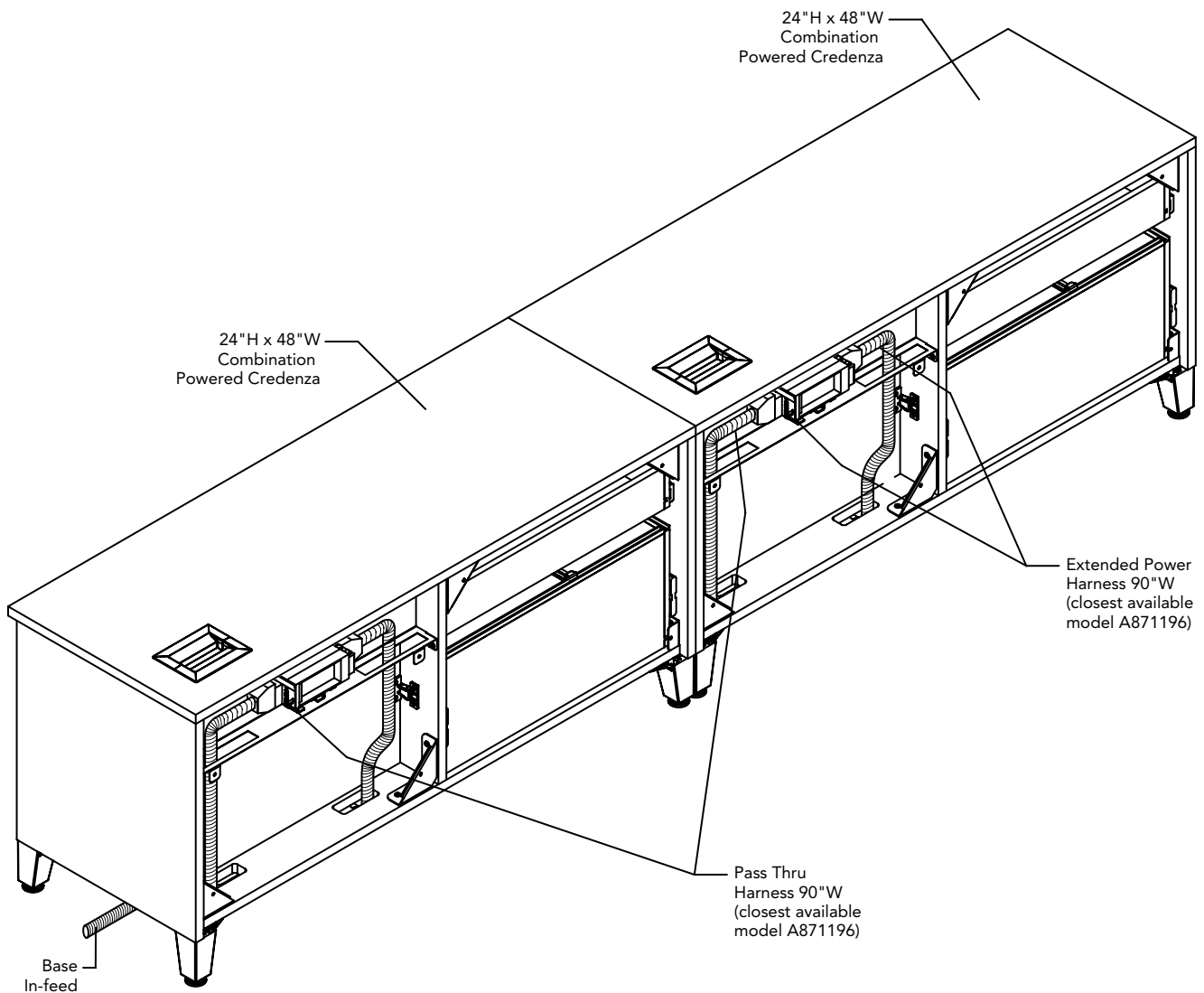

Routing Electrical: Credenza Side-to-Side and Spanning a Credenza

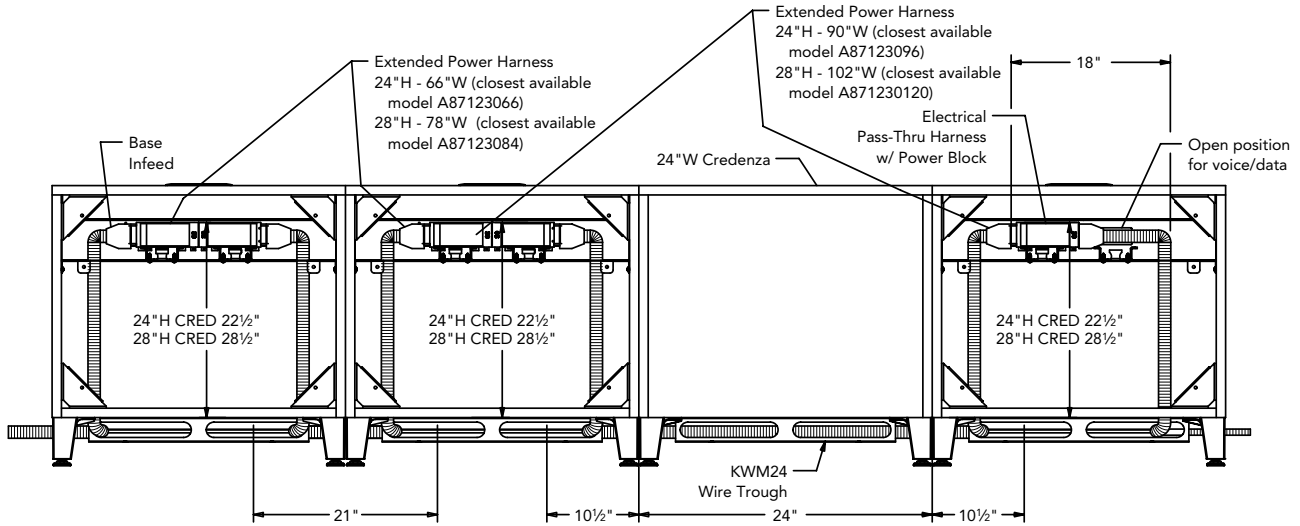

Jumper Situation:	Credenza Side-to-Side	Spanning a Credenza	Credenza Side-to-Side with an Open Position for Voice/Data
Formula:	<p>24" High Credenza to 24" High Credenza: $22\frac{1}{2} + 21 + 22\frac{1}{2} = 66$" Extended Power Harness (A87123066)</p> <p>28" High Credenza to 28" High Credenza: $28\frac{1}{2} + 21 + 28\frac{1}{2} = 78$" Extended Power Harness (closest available model A87123084)</p>	<p>Add width of credenza being spanned to credenza side-to-side(s) extended power harness length:</p> <p>24" High Credenza = $66 + 24 = 90$" Extended Power Harness (closest available model A87123096)</p> <p>28" High Credenza = $78 + 24 = 102$" Extended Power Harness (closest available model A871230120)</p>	<p>Add distance spanning open location by adding 18" to credenza side-to-side extended power harness length:</p> <p>24" High Credenza = $66 + 18 = 84$" Electrical Pass-Thru Harness w/Power Block (closest available model A871196)</p> <p>28" High Credenza = $78 + 18 = 96$" Electrical Pass-Thru Harness w/Power Block (A871196)</p>

ALIGN METAL SPEC
ALIGN PRICING
ESSENTIALS SPEC
ESSENTIALS PRICING
VERTICALS
INVOLVE SPEC
INVOLVE PRICING
ALIGN VENEER

Routing Electrical in 3 – 48"W Sliding Door Powered Credenzas

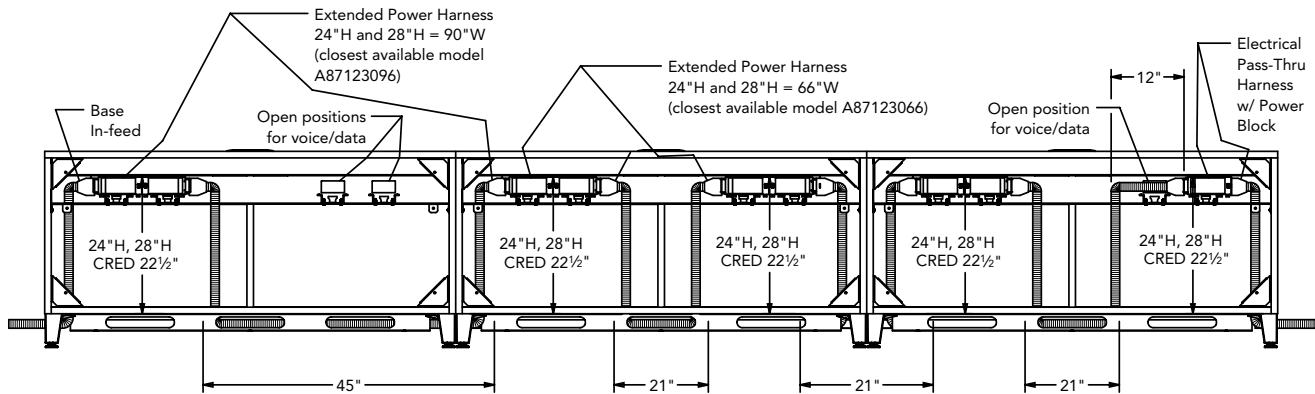

Jumper Situation:	Credenza side-to-side: spanning open positions for voice/data	Spanning center septum within a 48"W sliding door credenza	Spanning single open position for voice/data
Formula:	<p>24" High Credenza to 24" High Credenza: $22\frac{1}{2} + 45 + 22\frac{1}{2} = 90$" Extended Power Harness (closest available model A87123096)</p> <p>28" High Credenza to 28" High Credenza: $22\frac{1}{2} + 45 + 22\frac{1}{2} = 90$" Extended Power Harness (closest available model A87123096)</p>	<p>24" High Credenza to 24" High Credenza: $22\frac{1}{2} + 21 + 22\frac{1}{2} = 66$" Extended Power Harness (A87123066)</p> <p>28" High Credenza to 28" High Credenza: $22\frac{1}{2} + 21 + 22\frac{1}{2} = 66$" Extended Power Harness (A87123066)</p>	<p>Add distance spanning open location by adding 12" to credenza to credenza extended power harness length:</p> <p>24" High Credenza to 24" High Credenza: $22\frac{1}{2} + 21 + 22\frac{1}{2} + 12 = 78$" Extended Power Harness (closest available model A87123084)</p> <p>28" High Credenza to 28" High Credenza: $22\frac{1}{2} + 21 + 22\frac{1}{2} + 12 = 78$" Extended Power Harness (closest available model A87123084)</p>

Routing Electrical in 3 Lateral/Open Combination Powered Credenzas

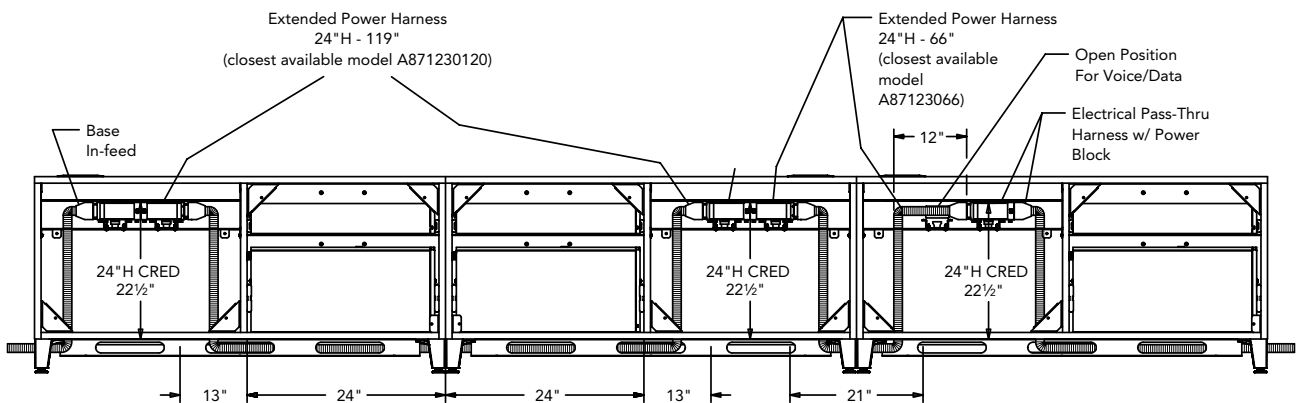

Jumper Situation:	Spanning a combo credenza (lateral drawers)	Credenza side-to-side (open side to open side)	Credenza to credenza with an open position for voice/data (open side to open side)
Formula:	<p>Add combo credenza drawer width being spanned to credenza to credenza(s) extended power harness length:</p> <p>28" High Credenza = $22\frac{1}{2} + 13 + 24 + 24 + 13 + 22\frac{1}{2} = 119$" Extended Power Harness (closest available model A871230120)</p>	<p>24" High Credenza to 24" High Credenza: $22\frac{1}{2} + 21 + 22\frac{1}{2} = 66$" Extended Power Harness (A87123066)</p>	<p>Add distance spanning open location by adding 12" to credenza to credenza extended power harness length:</p> <p>24" High Credenza to 24" High Credenza: $66 + 12 = 78$" Extended Power Harness (closest available model A87123084)</p>

Powered Credenzas (pages 152-154)

- Powered credenzas are power ready and require electrical harnesses, in-feed, and receptacles — order separately.
- Involve powered credenzas utilize the same 8-wire electrical system as used in Allsteel panel systems.
- Receptacle knockouts in the upper wire trough must be filled with a duplex receptacle, data port, or wire management grommet model TAWG; or there will be visible openings.
- Footed design with choice of feet that coordinate with either Stride or Terrace. Powered credenzas are not available with plinth base design.
- Three pull options: arch, square, or straight.
- ¼" thick high-pressure laminated particle board with laser fused edge banding and European cam-and-pin construction.
- Available laminates: solid, woodgrain, or two-tone (case one laminate / front (door or drawer) a different laminate).
- Doors and drawers lock except for non-locking UL models.
- Single sided sliding door units are non-handed; open half depends on door position. Door locks in either position.
- When routing electrical from a panel to a credenza or from a credenza to a panel, the credenza must be attached to the panel using a storage to panel bracket kit (page 125).
- When routing electrical from one credenza to an adjacent credenza or storage unit, units must be ganged together using the appropriate footed ganging bracket kit (page 125).
- Electrified credenzas w/drawers cannot be used as a standalone unit.
- When using an electrified credenza to support a panel (side mounting only), a back is required on the unit.
- UL Compliant sliding door credenzas do not have locks. Compliant model numbers have a "UL" suffix and are listed on pages 152-154.
- All powered credenzas ship without a laminate back. Laminate backs unique for powered units need to be ordered separately for any application where back is exposed. Box/lateral with open side units used in freestanding applications require a back for stability.
- Credenza backs for powered credenzas are available in woodgrain and solid laminate colors. 72"W credenza backs are limited to solid laminate colors only.
- Powered credenzas are available in 2 heights — 24"H and 28"H.
- 24"H powered credenzas ship with a top. Top has grommet installed.
- 28"H powered credenzas ship without a top. Credenza tops 36"W and 48"W can be ordered separately with or without grommet cutout(s) and are worksurface thickness. Grommets are ordered separately for credenza tops with grommet cutouts.
- A grommet brush kit is available for electrical credenza grommets as an accessory (page 157).
- Credenzas ship with a removable internal back that can be removed from the front of the unit to route electrical and data cords.
- Interior and bottom exterior wire trough is always black.
- Pullout shelves can be used in open cubby space with box/lateral credenzas with septum (exception of sliding door credenzas with septum).

Grommet Locations for 24"H w/Tops (pages 155)

- Sliding door credenzas — grommet centered
- Open binder/support credenzas — grommet centered
- Open combo credenzas — grommet on corner of open side.

Ganging Brackets (page 125)

- Ganging brackets attach to underside of credenzas.
- When routing electrical from one credenza to an adjacent credenza or storage unit, units must be ganged together using the appropriate footed or plinth base ganging bracket kit (page 125).

Cam Cover Kits (page 125)

- 24"H and 28"H credenzas ship without cam covers. Cam cover kits can be ordered separately. 20 cam covers in each kit.

Cushions for Credenzas (page 124)

- Cushions are for use on 24"H credenzas to create additional seating.

Metal Shelves (pages 126 and 127)

- Pullout shelves can be used in any open cubby space — place at the bottom of a unit or anywhere vertically. Units have a 50 lb. weight capacity and are field installed using supplied template.
- Pullout shelves are 2"H x 18"W, 24"W, 30"W, or 36"W; and 12"D for 18"D powered storage units, or 18"D for 24"D powered storage units.
- Additional metal shelves with pins in dimensions for open units are available in Core, Select, and Accent paint colors.

Laptop Drawer — U7WDA (page 125)

- Drawer body made of sheet metal.
- Drawer front made of ¼" particle board with high pressure laminate on both sides and fused laser edge banding.
- Core removable lock is located on right side drawer front
- 17½"W x 18"D x 3¾"H Outside (interior 13"W x 16"D x 1¾"H)
- Minimum surface depth is 21" for surfaces not using an external stiffener; and 27" for surfaces using an external stiffener.
- Drawer extends 16"
- Maximum load: 45 lbs (functional BIFMA load)
- Drawer assembly and cover have cut out in back to allow for cables to exit drawer.
- Distance from floor to bottom of unit w/glides fully retracted is 24¾".
- Does not interfere with Further leg mounting plates so drawer can be placed directly next to either a system or table leg.
- When being placed next tower storage using the tower ell bracket (Z6LB) to support surface the drawer must be inset 3" to clear the ell bracket.
- Can be placed directly next to any support storage from any Allsteel product line (excluding towers).
- Flat brackets — drawer must be offset 3" from seam between surfaces to clear the bracket. See illustration at left.
- Can be used with rabbit edge worksurface models but there will be a larger reveal between surface and drawer.
- Can be used with knife edge worksurface models but reveal and depth need to be considered.

Involve®

Front View

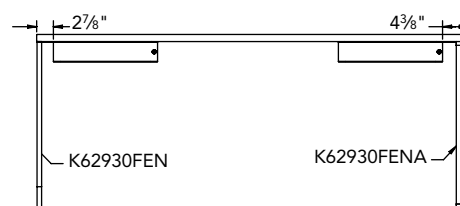

Top View

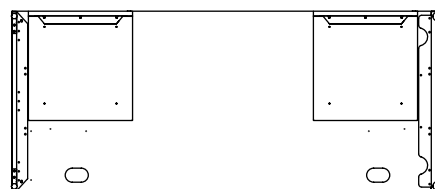

Involve

- Open Legs – drawer must be offset 4¾" from worksurface edge to clear support mounting bracket.
- Closed End Supports – drawer must be offset 2¾" to clear support mounting bracket.
- See illustrations above.

Electrical Harnesses in Powered Credenzas (page 156)

- 18"W and 24"W open binder/support credenza and 48"W combo credenzas can only use a single block pass-thru harness.
- 30" and 36"W open binder/support credenzas can use two block extended electrical power harnesses.
- 36" and 48"W sliding door credenzas can use two block extended electrical power harnesses.
- 60" and 72"W combo credenzas can use two block extended electrical power harnesses.
- The type and length of power harnesses required varies depending on adjacent storage. Refer to configurations shown on pages 106-113.

Extended Electrical Power Harnesses (page 156)

- Extended electrical power harnesses distribute power in powered credenzas, except 18"W and 24"W open binder/support and 48"W combo credenza units which require a pass-thru harness.
- Harness power blocks snap directly onto mounting brackets in credenza.
- Extended power harnesses accept two duplex receptacles per harness in powered credenzas.
- All power harnesses will stretch 3½".

Electrical Pass-thru Harnesses (page 156)

- Electrical pass-thru harnesses distribute power in powered credenzas and will accept one duplex receptacle.
- All pass-thru harnesses will stretch 3½".

Electrical Pass-thru Cable (page 156)

- Electrical pass-thru cables distribute power through any credenza where receptacles are not required.

Electrical Jumper Cable (page 157)

- Jumper cables plug into power block end of electrical power harness or electrical pass-thru harness.

Duplex Receptacles (page 157)

- Duplex receptacles snap into power blocks of harnesses.
- Ordered separately, receptacles are available in seven colors and are labeled to indicate circuit number: 1, 2, 3, or 4.
- 18"W and 24"W open binder/support and 48"W combo credenzas accept one duplex receptacle.
- 30" and 36"W open binder/support credenzas; 36"W sliding door credenzas; and 60" and 72"W combo credenzas will accept two duplex receptacles.
- 48"W sliding door credenzas will accept up to four duplex receptacles.

Electrical In-Feed Cable (page 157)

- Power in-feed cables deliver power from building to system.
- Select quantity of in-feed cables depending on individual power requirements.

Cable Routing in Bottom Wire Troughs (page 157)

- When routing electrical in a spanning credenza application, the corresponding width bottom wire trough needs to be ordered for any non-electrified credenzas being spanned.
- Without the 8-wire electrical running through the trough, the wire trough can accommodate up to 40 voice/data cables (.25 dia.) when banded together.
- If the 8-wire electrical is running through the trough, the wire trough can accommodate up to 25 voice/data cables (.25 dia.) when banded together.

Pop-Up Power (page 157)

- Contemporary pop-up caddy (model # S914P06GC or S914P06GH) used in place of plastic electrical grommet K6EGK in the field to provide easy access to two electrical receptacles.
- No field porting of credenza top is required.

Grommet Kit K6EGK for Involve (page 157)

- Rectangular plastic grommet for Involve 28"H tops for powered credenzas (page 155).

Grommet Brush (page 157)

- Brush assembly that fits into K6EGK grommet opening.

Wireway Grommets (page 157)

- Comes in pack of 6 (black only), and fits into any receptacle opening.
- Used when routing wires through receptacle opening.

AMP Data Faceplates (page 157)

- Fit into receptacle openings in Involve powered credenzas.
- Models available in three-port or four-port units in Black or Almond.

Involve® Laminate Wood Storage

Leg Base Pedestals

For specification information see pages 92-101.

GSA SIN 711-2

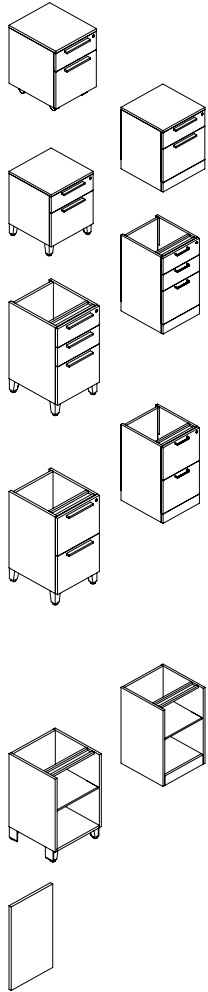

Description	Solid Color "KL" (Feet) or "KLP" (Plinth); Or prefix for Woodgrain or Two-Tone "K2T" (Feet) or "K2TP" (Plinth) Model	Lock Qty	L1 Laminate List Price	UPCHARGES*			
				L2 Laminate Case	L2 Laminate Front	L3 Laminate Case	L3 Laminate Front
Mobile Pedestal 24"H — Box/File (laminate back; with top)							
15½"W x 18"D Box/File (shown)	KL241518MBF	1	\$ 1201	N/A	N/A	N/A	N/A
15½"W x 18"D Box/File	K2T241518MBF	1	\$ 1201	\$ 42	\$ 20	\$ 84	\$ 36
Freestanding Pedestals 24"H — Box/File (unfinished back; with top)#							
18"W x 18"D Box/File (shown)	K 241818BF	1	\$ 1302	\$ 46	\$ 21	\$ 90	\$ 39
18"W x 24"D Box/File	K 241824BF	1	\$ 1353	\$ 47	\$ 21	\$ 93	\$ 41
Support Pedestals 28"H — Box/Box/File (unfinished back; without top)#							
15½"W x 18"D Box/Box/File (shown)	K 281518BBF	1	\$ 1455	\$ 50	\$ 23	\$ 99	\$ 43
18"W x 18"D Box/Box/File	K 281818BBF	1	\$ 1548	\$ 50	\$ 24	\$ 108	\$ 47
15½"W x 24"D Box/Box/File	K 281524BBF	1	\$ 1514	\$ 52	\$ 23	\$ 105	\$ 46
18"W x 24"D Box/Box/File	K 281824BBF	1	\$ 1611	\$ 52	\$ 24	\$ 111	\$ 48
15½"W x 30"D Box/Box/File	K 281530BBF	1	\$ 1894	\$ 64	\$ 30	\$ 131	\$ 56
18"W x 30"D Box/Box/File	K 281830BBF	1	\$ 2007	\$ 64	\$ 31	\$ 131	\$ 59
Support Pedestals 28"H — File/File (unfinished back; without top)#							
15½"W x 18"D File/File (shown)	K 281518FF	1	\$ 1302	\$ 46	\$ 21	\$ 90	\$ 39
18"W x 18"D File/File	K 281818FF	1	\$ 1395	\$ 48	\$ 22	\$ 96	\$ 42
15½"W x 24"D File/File	K 281524FF	1	\$ 1353	\$ 47	\$ 21	\$ 93	\$ 41
18"W x 24"D File/File	K 281824FF	1	\$ 1449	\$ 50	\$ 23	\$ 99	\$ 43
15½"W x 30"D File/File	K 281530FF	1	\$ 1691	\$ 58	\$ 27	\$ 116	\$ 50
18"W x 30"D File/File	K 281830FF	1	\$ 1792	\$ 61	\$ 28	\$ 124	\$ 53
Support Pedestals 28"H — Open with Metal Shelf (laminate back; without top)							
18"W x 18"D	K 281818A		\$ 1238	\$ 42		\$ 85	
18"W x 24"D	K 281824A		\$ 1288	\$ 44		\$ 89	
Laminate Backs (optional for Pedestal with unfinished back)							
15½"W for 28"H — Footed Base	KLCB2815		\$ 99	\$ 6		\$ 11	
15½"W for 28"H — Plinth Base	KLPCB2815		\$ 250	\$ 13		\$ 26	
18"W for 24"H — Footed Base	KLCB2418		\$ 99	\$ 66		\$ 11	
18"W for 24"H — Plinth Base	KLPCB2418		\$ 244	\$ 13		\$ 24	
18"W for 28"H — Footed Base (shown)	KLCB2818		\$ 105	\$ 6		\$ 11	
18"W for 28"H — Plinth Base	KLPCB2818		\$ 258	\$ 13		\$ 26	

*Upcharges are added to laminate list price depending on woodgrain laminate selection.
Unit may require counterweight kits, see page 99.

How to specify — Select the Model Number from above.	1st Option: Foot Type (if applicable): TF Terrace Foot ZF Stride Foot (Add \$77)	2nd Option: Foot Paint Color (if applicable): C S See inside front cover for finishes. Stride is limited to PR6 Silver.	3rd Option: Pull Type (if applicable): AP Arch SP Square Pull HP Straight Pull	4th Option: Pull Color (if applicable): PR6 Silver	5th Option: Metal Shelf Color (if applicable): C S A See inside front cover for finishes. Add \$26 for Select P2 (except PR6) or \$48 for Accent P3 Paints.
K .		P .		P R 6 .	.

Continued below ▼

6th Option: FSC Certified Wood: FSC Select for FSC Certified Wood X No FSC	7th Option: Laminate Color: See inside front cover for finishes. (If two-tone list case color here.)	8th Option: Matching Edge: See inside front cover for finishes.	9th Option: 2nd Laminate Color (Front) (if applicable): See inside front cover for finishes.	10th Option: Matching Edge (if applicable): See inside front cover for finishes.	11th Option: Lock (if applicable): STD Standard OMT Omit Lock Core (Deduct \$18)	12th Option: Lock Color (if applicable): EL Silver
.	E L .

Examples: K2T241818BF.TFPO8.APPR6.X.LWCWDC.LWCWDC.STDEL
KL241818BF.ZFPR6.SPPR6.FSC.LM11EV.STDEL.OMT

Involve® Laminate Wood Storage

17½"H Credenzas and Table

For specification information see pages 92-101.

GSA SIN 711-2

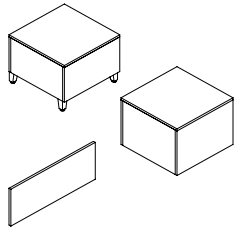
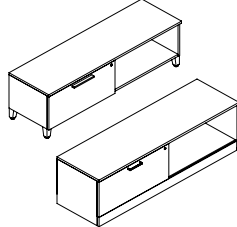
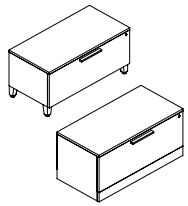

Description	Solid Color "KL" (Feet) or "KLP" (Plinth); Or prefix for Woodgrain or Two-Tone "K2T" (Feet) or "K2TP" (Plinth) Model	Lock Qty	L1 Laminate List Price	UPCHARGES*				
				L2 Laminate		L3 Laminate		
				Case	Front	Case	Laminate	Front
17½"H Credenza — Single Lateral (unfinished back)#								
30"W x 18"D	K <input type="checkbox"/> F173018	1	\$ 1504	\$ 52	\$ 23	\$ 102	\$ 44	
36"W x 18"D (shown)	K <input type="checkbox"/> F173618	1	\$ 1627	\$ 56	\$ 26	\$ 112	\$ 48	
30"W x 24"D	K <input type="checkbox"/> F173024	1	\$ 1564	\$ 53	\$ 24	\$ 108	\$ 47	
36"W x 24"D	K <input type="checkbox"/> F173624	1	\$ 1694	\$ 58	\$ 28	\$ 116	\$ 50	
17½"H Credenza — Single Lateral with Open Cubby#								
48"W x 18"D Lat/RH Open	K <input type="checkbox"/> 174818RAF	1	\$ 1857	\$ 62	\$ 29	\$ 129	\$ 54	
48"W x 18"D LH Open/Lat	K <input type="checkbox"/> 174818LAF	1	\$ 1857	\$ 62	\$ 29	\$ 129	\$ 54	
60"W x 18"D Lat/RH Open (shown)	K <input type="checkbox"/> 176018RAF	1	\$ 2105	\$ 70	\$ 32	\$ 146	\$ 61	
60"W x 18"D LH Open/Lat	K <input type="checkbox"/> 176018LAF	1	\$ 2105	\$ 70	\$ 32	\$ 146	\$ 61	
72"W x 18"D Lat/RH Open**	K <input type="checkbox"/> 177218RAF	1	\$ 2290	N/A	\$ 34	N/A	\$ 65	
72"W x 18"D LH Open/Lat**	K <input type="checkbox"/> 177218LAF	1	\$ 2290	N/A	\$ 34	N/A	\$ 65	
48"W x 24"D Lat/RH Open	K <input type="checkbox"/> 174824RAF	1	\$ 1931	\$ 65	\$ 30	\$ 133	\$ 57	
48"W x 24"D LH Open/Lat	K <input type="checkbox"/> 174824LAF	1	\$ 1931	\$ 65	\$ 30	\$ 133	\$ 57	
60"W x 24"D Lat/RH Open	K <input type="checkbox"/> 176024RAF	1	\$ 2190	\$ 75	\$ 34	\$ 152	\$ 63	
60"W x 24"D LH Open/Lat	K <input type="checkbox"/> 176024LAF	1	\$ 2190	\$ 75	\$ 34	\$ 152	\$ 63	
72"W x 24"D Lat/RH Open**	K <input type="checkbox"/> 177224RAF	1	\$ 2382	N/A	\$ 35	N/A	\$ 65	
72"W x 24"D LH Open/Lat**	K <input type="checkbox"/> 177224LAF	1	\$ 2382	N/A	\$ 35	N/A	\$ 65	
17½"H Corner Table (closed; with top)								
24"W x 24"D	K <input type="checkbox"/> 172424CT		\$ 1281	\$ 44	\$ 44	\$ 89	\$ 89	

Laminate Back (optional for 17½"H Credenza with unfinished back)			L2 Laminate	L3 Laminate
30"W – Footed Base	KLCB1730	\$ 119	\$ 7	\$ 12
30"W – Plinth Base	KLPCB1730	\$ 237	\$ 13	\$ 26
36"W – Footed Base (shown)	KLCB1736	\$ 172	\$ 9	\$ 18
36"W – Plinth Base (shown)	KLPCB1736	\$ 243	\$ 13	\$ 26

*Upcharges are added to laminate list price depending on woodgrain laminate selection. **72"W credenza case must always be solid color laminate. #Unit may require counterweights kits, see page 99.

<p>How to specify — Select the Model Number from above.</p> <p>KL Feet / Solid Color KLP Plinth/ Solid Color K2T Feet / Woodgrain or Two-Tone K2TP Plinth / Woodgrain or Two-Tone</p>	<p>1st Option: Foot Type (if applicable):</p> <p>TF Terrace Foot ZF Stride Foot (Add \$77)</p>	<p>2nd Option: Foot Paint Color (if applicable):</p> <p>☉ ☐</p> <p>See inside front cover for finishes. Stride is limited to PR6 Silver.</p>	<p>3rd Option: Pull Type (if applicable):</p> <p>AP Arch SP Square Pull HP Straight Pull</p>	<p>4th Option: Pull Color (if applicable):</p> <p>PR6 Silver</p>	<p>5th Option: FSC Certified Wood:</p> <p>FSC Select for FSC Certified Wood X No FSC</p>
	<p>K . </p>	<p>P .</p>	<p>P R 6 .</p>	<p> .</p>	

Continued below ▼

<p>6th Option: Laminate** Color: See inside front cover for finishes. (If two-tone list case color here.)</p>	<p>7th Option: Matching Edge: See inside front cover for finishes.</p>	<p>8th Option: 2nd Laminate Color (Front) (if applicable): See inside front cover for finishes.</p>	<p>9th Option: Matching Edge (if applicable): See inside front cover for finishes.</p>	<p>10th Option: Lock (if applicable): STD Standard OMT Omit Lock Core (Deduct \$18)</p>	<p>11th Option: Lock Color (if applicable): EL Silver</p>
<p> </p>	<p> .</p>	<p> </p>	<p> .</p>	<p> </p>	<p>E L </p>

Examples: K2TF173018.TFPO8.APPR6.X.LWCWEDCW.LWCWEDCW.STDEL

KL174818RAF.ZFPR6.SPPR6.FSC.LM11EV.OMT KLCB1730.FSC.LM11EV

Involve[®] Laminate Wood Storage

24"H Credenzas

For specification information see pages 92-101.

GSA SIN 711-2

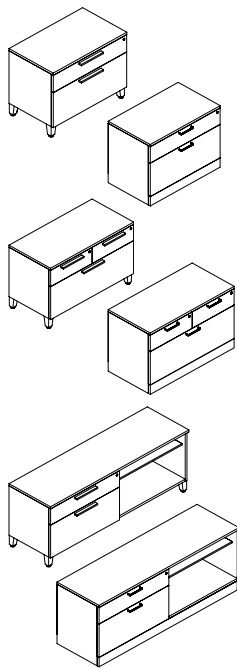

Description	Solid Color "KL" (Feet) or "KLP" (Plinth); Or prefix for Woodgrain or Two-Tone "K2T" (Feet) or "K2TP" (Plinth) Model	Lock Qty	L1 Laminate List Price	UPCHARGES*			
				L2 Laminate Case	L2 Laminate Front	L3 Laminate Case	L3 Laminate Front
24"H Credenza — Box/Lateral (unfinished back)#							
30"W x 18"D (shown)	K □ 243018BF	1	\$ 1700	\$ 58	\$ 28	\$ 116	\$ 50
30"W x 24"D	K □ 243024BF	1	\$ 1768	\$ 60	\$ 28	\$ 121	\$ 52
24"H Credenza — Box/Box/Lateral (unfinished back)#							
36"W x 18"D (shown)	K □ 243618E	2	\$ 1753	\$ 60	\$ 28	\$ 121	\$ 61
36"W x 24"D	K □ 243624E	2	\$ 1821	\$ 61	\$ 29	\$ 127	\$ 63
24"H Credenza — Box/Lateral and Open Side with Metal Shelf (finished back)#							
48"W x 18"D Lat/RH Open	K □ 244818RAF	1	\$ 2723	\$ 94	\$ 41	\$ 189	\$ 80
48"W x 18"D LH Open/Lat	K □ 244818LAF	1	\$ 2723	\$ 94	\$ 41	\$ 189	\$ 80
60"W x 18"D Lat/RH Open (shown)	K □ 246018RAF	1	\$ 2847	\$ 98	\$ 43	\$ 197	\$ 85
60"W x 18"D LH Open/Lat	K □ 246018LAF	1	\$ 2847	\$ 98	\$ 43	\$ 197	\$ 85
72"W x 18"D Lat/RH Open**	K □ 247218RAF	1	\$ 3094	N/A	N/A	N/A	N/A
72"W x 18"D LH Open/Lat**	K □ 247218LAF	1	\$ 3094	N/A	N/A	N/A	N/A
48"W x 24"D Lat/RH Open	K □ 244824RAF	1	\$ 2833	\$ 97	\$ 42	\$ 196	\$ 85
48"W x 24"D LH Open/Lat	K □ 244824LAF	1	\$ 2833	\$ 97	\$ 42	\$ 196	\$ 85
60"W x 24"D Lat/RH Open	K □ 246024RAF	1	\$ 2961	\$ 101	\$ 44	\$ 205	\$ 89
60"W x 24"D LH Open/Lat	K □ 246024LAF	1	\$ 2961	\$ 101	\$ 44	\$ 205	\$ 89
72"W x 24"D Lat/RH Open**	K □ 247224RAF	1	\$ 3218	N/A	N/A	N/A	N/A
72"W x 24"D LH Open/Lat**	K □ 247224LAF	1	\$ 3218	N/A	N/A	N/A	N/A



Laminate Back (optional for 24"H credenza with unfinished back)			L2 Laminate	L3 Laminate
30"W – Footed Base	KLCB2430	\$ 126	\$ 7	\$ 13
30"W – Plinth Base	KLPCB2430	\$ 243	\$ 13	\$ 26
36"W – Footed Base (shown)	KLCB2436	\$ 179	\$ 9	\$ 19
36"W – Plinth Base (shown)	KLPCB2436	\$ 250	\$ 13	\$ 27

*Upcharges are added to laminate list price depending on woodgrain laminate selection.

#Unit may require counterweight kits, see page 99.

**72"W credenza case must always be solid color laminate.

How to specify — Select the Model Number from above.	1st Option: Foot Type (if applicable):	2nd Option: Foot Paint Color (if applicable):	3rd Option: Pull Type (if applicable):	4th Option: Pull Color (if applicable):	5th Option: Metal Shelf Color (if applicable):
KL Feet / Solid Color KLP Plinth/ Solid Color K2T Feet / Woodgrain or Two-Tone K2TP Plinth / Woodgrain or Two-Tone	TF Terrace Foot ZF Stride Foot (Add \$77)	C S See inside front cover for finishes. Stride is limited to PR6 Silver.	AP Arch SP Square Pull HP Straight Pull	PR6 Silver	C S A See inside front cover for finishes. Add \$26 for Select P2 (except PR6) or \$48 for Accent P3 Paints.
K .	P .		P R 6 .		

Continued below ▼

6th Option: FSC Certified Wood: FSC Select for FSC Certified Wood X No FSC	7th Option: Laminate** Color: See inside front cover for finishes. (If two-tone list case color here.)	8th Option: Matching Edge: See inside front cover for finishes.	9th Option: 2nd Laminate Color (Front) (if applicable): See inside front cover for finishes.	10th Option: Matching Edge (if applicable): See inside front cover for finishes.	11th Option: Lock (if applicable): STD Standard OMT Omit Lock Core (deduct \$18 per lock)	12th Option: Lock Color (if applicable): EL Silver
.		.		.		E L

Examples: K2T243018BF.TFPO8.APPR6.PR6.X.LWCWEDCW.LWCWEDCW.STDEL
 KL244824RAF.ZFPR6.SPPR6.P7B.FSC.LM11E.V.OMT

Involve® Laminate Wood Storage

24"H Credenzas

For specification information see pages 92-101.

GSA SIN 711-2

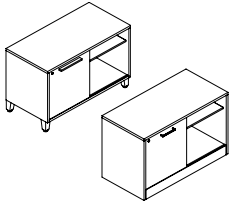

Description	Solid Color "KL" (Feet) or "KLP" (Plinth); Or prefix for Woodgrain or Two-Tone "K2T" (Feet) or "K2TP" (Plinth) Model	Lock Qty	L1 Laminate List Price	UPCHARGES*				
				L2 Laminate Case	L2 Laminate Front	L3 Laminate Case	L3 Laminate Front	
24"H Credenza — Sliding Door with Metal Shelf (non-handed)								
36"W x 18"D (shown)	K □ 243618N	1	\$ 1981	\$ 66	\$ 31	\$ 138	\$ 61	
36"W x 24"D	K □ 243624N	1	\$ 2061	\$ 68	\$ 32	\$ 143	\$ 60	
48"W x 18"D	K □ 244818N	1	\$ 2228	\$ 77	\$ 34	\$ 154	\$ 67	
48"W x 24"D	K □ 244824N	1	\$ 2317	\$ 79	\$ 35	\$ 159	\$ 70	

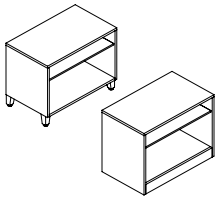

Description	Solid Color "KL" (Feet) or "KLP" (Plinth); Or prefix for Woodgrain or Two-Tone "K2T" (Feet) or "K2TP" (Plinth) Model	Lock Qty	L1 Laminate List Price	L2 Laminate	L3 Laminate
				Case	Front
24"H Credenza — Open Binder with Metal Shelf					
18"W x 18"D	K □ 241818A		\$ 1146	\$ 39	\$ 78
24"W x 18"D	K □ 242418A		\$ 1207	\$ 43	\$ 87
30"W x 18"D (shown)	K □ 243018A		\$ 1271	\$ 41	\$ 82
36"W x 18"D	K □ 243618A		\$ 1331	\$ 46	\$ 91
18"W x 24"D	K □ 241824A		\$ 1193	\$ 42	\$ 84
24"W x 24"D	K □ 242424A		\$ 1256	\$ 46	\$ 92
30"W x 24"D	K □ 243024A		\$ 1320	\$ 43	\$ 86
36"W x 24"D	K □ 243624A		\$ 1383	\$ 48	\$ 95

*Upcharges are added to laminate list price depending on woodgrain laminate selection.

Note: Additional pullout shelves can only be added to box/lateral credenzas with center septum.

<p>How to specify — Select the Model Number from above.</p> <p>KL Feet / Solid Color KLP Plinth/ Solid Color K2T Feet / Woodgrain or Two-Tone K2TP Plinth / Woodgrain or Two-Tone</p>	<p>1st Option: Foot Type (if applicable): TF Terrace Foot ZF Stride Foot (Add \$77)</p>	<p>2nd Option: Foot Paint (if applicable): C S See inside front cover for finishes. Stride is limited to PR6 Silver.</p>	<p>3rd Option: Pull Type (if applicable): AP Arch SP Square Pull HP Straight Pull</p>	<p>4th Option: Pull Color (if applicable): PR6 Silver</p>	<p>5th Option: Metal Shelf and Back Color (if applicable): C S A Add \$26 for Select P2 (except PR6) or \$48 for Accent P3 Paints on shelf.</p>
K .		P .		P R 6 .	.

Continued below ▼

<p>6th Option: FSC Certified Wood: FSC Select for FSC Certified Wood X No FSC</p>	<p>7th Option: Laminate Color: See inside front cover for finishes. (If two-tone list case color here.)</p>	<p>8th Option: Matching Edge: See inside front cover for finishes.</p>	<p>9th Option: 2nd Laminate Color (Front) (if applicable): See inside front cover for finishes.</p>	<p>10th Option: Matching Edge (if applicable): See inside front cover for finishes.</p>	<p>11th Option: Lock (if applicable): STD Standard OMT Omit Lock Core (deduct \$18 per lock)</p>	<p>12th Option: Lock Color (if applicable): EL Silver</p>
.		.		.		E L

Examples: K2T243618N.TFPQ8.APPR6.PR6.X.LWCWEDCW.LWCWEDCW.STDEL

KL243618DN.ZFPR6.SPPR6.P7B.FSC.LM11EV.OMT

Involve® Laminate Wood Storage

28"H Credenzas

For specification information see pages 92-101.

GSA SIN 711-2

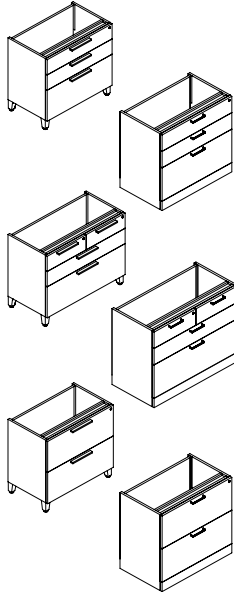

Description	Solid Color "KL" (Feet) or "KLP" (Plinth); Or prefix for Woodgrain or Two-Tone "K2T" (Feet) or "K2TP" (Plinth) Model	Lock Qty	L1 Laminate List Price	UPCHARGES*			
				L2 Laminate Case	L2 Laminate Front	L3 Laminate Case	L3 Laminate Front
28"H Support Credenza — Box/Box/Lateral (unfinished back; without top)#							
24"W x 18"D	K □ 282418BBF	1	\$ 1671	\$ 57	\$ 27	\$ 114	\$ 49
30"W x 18"D (shown)	K □ 283018BBF	1	\$ 1795	\$ 60	\$ 28	\$ 124	\$ 52
24"W x 24"D	K □ 282424BBF	1	\$ 1739	\$ 59	\$ 28	\$ 118	\$ 51
30"W x 24"D	K □ 283024BBF	1	\$ 1867	\$ 62	\$ 29	\$ 129	\$ 54

28"H Support Credenza — Box/Box/Project Drawer/Lateral (unfinished back; without top)#							
36"W x 18"D	K □ 283618E	2	\$ 2105	\$ 70	\$ 32	\$ 146	\$ 61
36"W x 24"D	K □ 283624E	2	\$ 2190	\$ 75	\$ 33	\$ 150	\$ 63

28"H Support Credenza — Lateral/Lateral (unfinished back; without top)#							
30"W x 18"D (shown)	K □ 283018FF	1	\$ 1611	\$ 56	\$ 24	\$ 111	\$ 48
36"W x 18"D	K □ 283618FF	1	\$ 1783	\$ 60	\$ 28	\$ 124	\$ 52
30"W x 24"D	K □ 283024FF	1	\$ 1673	\$ 57	\$ 27	\$ 115	\$ 50
36"W x 24"D	K □ 283624FF	1	\$ 1854	\$ 62	\$ 29	\$ 129	\$ 54



Laminate Back (optional for 28"H credenza with unfinished back)		Price	L2 Laminate	L3 Laminate
			Price	Price
24"W – Footed Base	KLCB2824	\$ 126	\$ 7	\$ 13
24"W – Plinth Base	KLPCB2824	\$ 250	\$ 13	\$ 27
30"W – Footed Base	KLCB2830	\$ 133	\$ 7	\$ 13
30"W – Plinth Base	KLPCB2830	\$ 262	\$ 14	\$ 28
36"W – Footed Base	KLCB2836	\$ 185	\$ 9	\$ 19
36"W – Plinth Base	KLPCB2836	\$ 288	\$ 14	\$ 29

*Upcharges are added to laminate list price depending on woodgrain laminate selection.
#Unit may require counterweight kits, see page 99.

<p>How to specify —</p> <p>Select the Model Number from above.</p> <p>KL Feet / Solid Color KLP Plinth/ Solid Color K2T Feet / Woodgrain or Two-Tone K2TP Plinth / Woodgrain or Two-Tone</p> <p>K . </p>	<p>1st Option:</p> <p>Foot Type (if applicable):</p> <p>TF Terrace Foot ZF Stride Foot (Add \$77)</p> <p> .</p>	<p>2nd Option:</p> <p>Foot Paint Color (if applicable):</p> <p>ⓐ ⓑ</p> <p>See inside front cover for finishes. Stride is limited to PR6 Silver.</p> <p>P .</p>	<p>3rd Option:</p> <p>Pull Type (if applicable):</p> <p>AP Arch SP Square Pull HP Straight Pull</p> <p> .</p>	<p>4th Option:</p> <p>Pull Color (if applicable):</p> <p>PR6 Silver</p> <p>P R 6 .</p>	<p>5th Option:</p> <p>Metal Shelf Color (if applicable):</p> <p>ⓐ ⓑ Ⓐ</p> <p>See inside front cover for finishes. Add \$26 for Select P2 (except PR6) or \$48 for Accent P3 Paints.</p> <p> .</p>
---	---	--	---	--	---

Continued below ▼

<p>6th Option:</p> <p>FSC Certified Wood:</p> <p>FSC Select for FSC Certified Wood X No FSC</p> <p> .</p>	<p>7th Option:</p> <p>Laminate Color:</p> <p>See inside front cover for finishes.</p> <p>(If two-tone list case color here.)</p> <p> .</p>	<p>8th Option:</p> <p>Matching Edge:</p> <p>See inside front cover for finishes.</p> <p> .</p>	<p>9th Option:</p> <p>2nd Laminate Color (Front) (if applicable):</p> <p>See inside front cover for finishes.</p> <p> .</p>	<p>10th Option:</p> <p>Matching Edge (if applicable):</p> <p>See inside front cover for finishes.</p> <p> .</p>	<p>11th Option:</p> <p>Lock (if applicable):</p> <p>STD Standard OMT Omit Lock Core (deduct \$18 per lock)</p> <p> .</p>	<p>12th Option:</p> <p>Lock Color (if applicable):</p> <p>EL Silver</p> <p>E L .</p>
---	--	--	---	---	--	--

Examples: K2T243618E.TFPQ8.APPR6.X.LWCWEDCW.LWCWEDCW.STDEL
KL243618N.ZFPR6.SP6.P7B.FSC.LM11EV.OMT KLCB2824.FSC.LM11EV

Involve® Laminate Wood Storage

28"H Credenzas

For specification information see pages 92-101.

GSA SIN 711-2

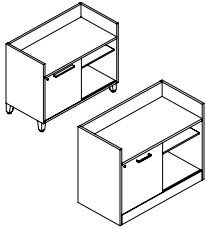

Description	Solid Color "KL" (Feet) or "KLP" (Plinth); Or prefix for Woodgrain or Two-Tone "K2T" (Feet) or "K2TP" (Plinth) Model	Lock Qty	L1 Laminate List Price	UPCHARGES*			
				L2 Laminate Case	L2 Laminate Front	L3 Laminate Case	L3 Laminate Front
28"H Support Credenza — Sliding Door with Metal Shelf (without top; non-handed)							
36"W x 18"D (shown)	K □ 283618N	1	\$ 2105	\$ 70	\$ 32	\$ 138	\$ 61
36"W x 24"D	K □ 283624N	1	\$ 2190	\$ 76	\$ 34	\$ 152	\$ 63
48"W x 18"D	K □ 284818N	1	\$ 2351	\$ 77	\$ 35	\$ 161	\$ 67
48"W x 24"D	K □ 284824N	1	\$ 2447	\$ 85	\$ 37	\$ 170	\$ 70

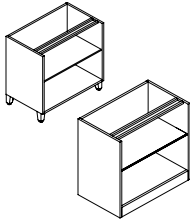

Description	Solid Color "KL" (Feet) or "KLP" (Plinth); Or prefix for Woodgrain or Two-Tone "K2T" (Feet) or "K2TP" (Plinth) Model	Lock Qty	L1 Laminate List Price	L2 Laminate	L3 Laminate
				Case	Front
28"H Support Credenza — Open Cubby with Metal Shelf (without top)					
24"W x 18"D	K □ 282418A		\$ 1302	\$ 44	\$ 90
30"W x 18"D (shown)	K □ 283018A		\$ 1363	\$ 49	\$ 97
36"W x 18"D	K □ 283618A		\$ 1423	\$ 49	\$ 97
24"W x 24"D	K □ 282424A		\$ 1353	\$ 47	\$ 93
30"W x 24"D	K □ 283024A		\$ 1416	\$ 47	\$ 93
36"W x 24"D	K □ 283624A		\$ 1482	\$ 50	\$ 100

*Upcharges are added to laminate list price depending on woodgrain laminate selection.

Note: Additional pullout shelves can only be added to box/lateral credenzas with center septum.

<p>How to specify —</p> <p>Select the Model Number from above.</p> <p>KL Feet / Solid Color KLP Plinth/ Solid Color K2T Feet / Woodgrain or Two-Tone K2TP Plinth / Woodgrain or Two-Tone</p>	<p><i>1st Option:</i></p> <p>Foot Type (if applicable):</p> <p>TF Terrace Foot ZF Stride Foot (Add \$77)</p>	<p><i>2nd Option:</i></p> <p>Foot Paint Color (if applicable):</p> <p>C S</p> <p>See inside front cover for finishes. Stride is limited to PR6 Silver.</p>	<p><i>3rd Option:</i></p> <p>Pull Type (if applicable):</p> <p>AP Arch SP Square Pull HP Straight Pull</p>	<p><i>4th Option:</i></p> <p>Pull Color (if applicable):</p> <p>PR6 Silver</p>	<p><i>5th Option:</i></p> <p>Metal Shelf Color (if applicable):</p> <p>C S A</p> <p>Add \$26 for Select P2 (except PR6) or \$48 for Accent P3 Paints on shelf.</p>
K .		P .		P R 6 .	.

Continued below ▼

<p><i>6th Option:</i></p> <p>FSC Certified Wood:</p> <p>FSC Select for FSC Certified Wood X No FSC</p>	<p><i>7th Option:</i></p> <p>Laminate Color:</p> <p>See inside front cover for finishes. (If two-tone list case color here.)</p>	<p><i>8th Option:</i></p> <p>Matching Edge:</p> <p>See inside front cover for finishes.</p>	<p><i>9th Option:</i></p> <p>2nd Laminate Color (Front) (if applicable):</p> <p>See inside front cover for finishes.</p>	<p><i>10th Option:</i></p> <p>Matching Edge (if applicable):</p> <p>See inside front cover for finishes.</p>	<p><i>11th Option:</i></p> <p>Lock:</p> <p>STD Standard OMT Omit Lock Core (deduct \$18 per lock)</p>	<p><i>12th Option:</i></p> <p>Lock Color (if applicable):</p> <p>EL Silver</p>
.		.		.		E L

Examples: K2T283618N.TFPQ8.APPR6.PR6.X.LWCWEDCW.LWCWEDCW.STDEL KL283618A.ZFPR6.SP6R6.P7B.FSC.LM11EV.OMT

Involve® Laminate Wood Storage

42"H Storage

For specification information see pages 92-101.

GSA SIN 711-2

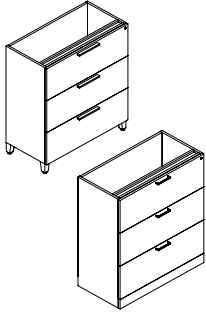

Description	Solid Color "KL" (Feet) or "KLP" (Plinth); Or prefix for Woodgrain or Two-Tone "K2T" (Feet) or "K2TP" (Plinth) Model	Lock Qty	L1 Laminates List Price	UPCHARGES*			
				L2 Laminates Case	L2 Laminates Front	L3 Laminates Case	L3 Laminates Front
42"H Credenza — 3 Drawer Lateral (without top; back has exposed fasteners)							
36"W x 18"D	K□ 423618FFF	1	\$ 2785	\$ 96	\$ 42	\$ 192	\$ 84

<p>How to specify — Select the Model Number from above.</p> <p>KL Feet / Solid Color KLP Plinth/ Solid Color K2T Feet / Woodgrain or Two-Tone K2TP Plinth / Woodgrain or Two-Tone</p>	<p>1st Option: Foot Type (if applicable): TF Terrace Foot ZF Stride Foot (Add \$77)</p>	<p>2nd Option: Foot Paint (if applicable): C S See inside front cover for finishes. Stride is limited to PR6 Silver.</p>	<p>3rd Option: Pull Type (if applicable): AP Arch SP Square Pull HP Straight Pull</p>	<p>4th Option: Pull Color (if applicable): PR6 Silver</p>	<p>5th Option: Metal Shelf Color (if applicable): C S A See inside front cover for finishes. Add \$48 for Select P2 (except PR6) or \$95 for Accent P3 Paints.</p>
K .		P .		P R 6 .	.

Continued below ▼

<p>6th Option: FSC Certified Wood: FSC Select for FSC Certified Wood X No FSC</p>	<p>7th Option: Laminate Color: See inside front cover for finishes. (If two-tone list case color here.)</p>	<p>8th Option: Matching Edge: See inside front cover for finishes.</p>	<p>9th Option: 2nd Laminate Color (Front) (if applicable): See inside front cover for finishes.</p>	<p>10th Option: Matching Edge (if applicable): See inside front cover for finishes.</p>	<p>11th Option: Lock Option (if applicable): STD Standard OMT Omit Lock Core (deduct \$18 per lock)</p>	<p>12th Option: Lock Color (if applicable): EL Silver</p>
.		.		.		E L

Examples: K2T423618FFF.TFPO8.APPR6.X.LWCWEDCW.LWCWEDCW.STDEL
KL423618FFF.ZFPR6.SPPR6.P7B.FSC.LM11EV.OMT

Involve® Laminate Wood Storage

Ped / Credenza Tops and Cushions

For specification information see pages 92-101.

GSA SIN 711-2

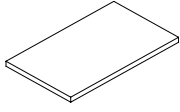

Description	Model	L1	L2	L3
		Laminate List Price	Laminate List Price	Laminate List Price
Laminate Tops — 18"D				
18"W	K5CT1818L	\$ 233	\$ 245	\$ 256
24"W	K5CT1824L	\$ 252	\$ 265	\$ 278
30"W (shown)	K5CT1830L	\$ 271	\$ 285	\$ 298
36"W	K5CT1836L	\$ 291	\$ 305	\$ 320
48"W	K5CT1848L	\$ 313	\$ 328	\$ 343

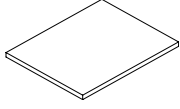

Laminate Tops — 24"D				
18"W	K5CT2418L	\$ 241	\$ 253	\$ 265
24"W	K5CT2424L	\$ 260	\$ 273	\$ 286
30"W (shown)	K5CT2430L	\$ 279	\$ 293	\$ 307
36"W	K5CT2436L	\$ 301	\$ 316	\$ 330
48"W	K5CT2448L	\$ 324	\$ 342	\$ 355

*Upcharges are added to laminate list price depending on woodgrain laminate selection.

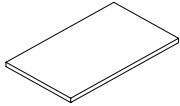

Description	Model	List Price									
		Grade 1	Grade 2	Grade 3	Grade 4	Grade 5	Grade 6	Grade 7	Grade 8	Grade L1	Grade L2
Ped/Credenza Cushions — 18"D											
15 1/8"W	K5CT1815SC	\$ 202	\$ 232	\$ 249	\$ 267	\$ 287	\$ 304	\$ 323	\$ 345	\$ 403	\$ 546
18"W	K5CT1818SC	\$ 216	\$ 247	\$ 265	\$ 284	\$ 307	\$ 325	\$ 345	\$ 366	\$ 428	\$ 579
24"W	K5CT1824SC	\$ 232	\$ 265	\$ 284	\$ 308	\$ 329	\$ 349	\$ 372	\$ 393	\$ 451	\$ 611
30"W	K5CT1830SC	\$ 250	\$ 285	\$ 306	\$ 330	\$ 354	\$ 378	\$ 400	\$ 427	\$ 485	\$ 658
36"W	K5CT1836SC	\$ 280	\$ 317	\$ 341	\$ 370	\$ 392	\$ 418	\$ 440	\$ 469	\$ 535	\$ 719
48"W	K5CT1848SC	\$ 291	\$ 330	\$ 356	\$ 386	\$ 412	\$ 439	\$ 468	\$ 496	\$ 566	\$ 766

COM Yardage: 0.7 yards, 15 1/8"W and 18"W yield 2 cushions. COL 3.5 sq.ft. 15 1/8"W and 18"W; 7 sq.ft. others. No vinyls.

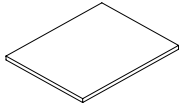

Ped/Credenza Cushions — 24"D											
15 1/8"W	K5CT2415SC	\$ 212	\$ 242	\$ 260	\$ 279	\$ 301	\$ 319	\$ 340	\$ 360	\$ 420	\$ 568
18"W	K5CT2418SC	\$ 223	\$ 255	\$ 273	\$ 293	\$ 316	\$ 335	\$ 356	\$ 378	\$ 442	\$ 601
24"W	K5CT2424SC	\$ 241	\$ 275	\$ 294	\$ 319	\$ 341	\$ 362	\$ 386	\$ 411	\$ 479	\$ 648
30"W	K5CT2430SC	\$ 260	\$ 296	\$ 319	\$ 345	\$ 368	\$ 392	\$ 415	\$ 442	\$ 516	\$ 701
36"W	K5CT2436SC	\$ 280	\$ 318	\$ 343	\$ 372	\$ 396	\$ 423	\$ 449	\$ 476	\$ 556	\$ 757
48"W	K5CT2448SC	\$ 302	\$ 343	\$ 369	\$ 400	\$ 429	\$ 456	\$ 484	\$ 514	\$ 601	\$ 813

COM Yardage: 0.9 yards, 15 1/8"W and 18"W yield 2 cushions. COL 4 sq.ft. 15 1/8"W and 18"W; 8 sq.ft. others. No vinyls.

How to specify — Select the Model Number from above.	<i>1st Option:</i> Laminate Color (if applicable): See inside front cover for finishes. (Woodgrain upcharges are listed above).	<i>1st Option:</i> Upholstery (if applicable): Specify seating upholstery.	<i>2nd Option:</i> Matching Edge Color (if applicable): See inside front cover for finishes.
	_____ . _____ .	_____ .	_____ .

Examples: K5CT1818L.LM14.EW K5CT1818L.LWNW.DN
 K5CT1815SC.CTU49 K5CT1815SC.WTH01

Involve® Laminate Wood Storage

Accessories

For specification information see pages 92-101.

GSA SIN 711-2



Description	Model	Core Paint		Select Paint	
		P1 List Price	P2 List Price	P2 List Price	P2 List Price
Storage-to-Panel Bracket Kits for 24"H and 28"H Credenzas only — back or side mount, painted metal					
24"H Left (requires laminate back for back mounting) (shown)	K624PBKL	\$ 105		\$ 119	
24"H Right (requires laminate back for back mounting)	K624PBKR	\$ 105		\$ 119	
28"H Left (requires laminate back for back mounting)	K630PBKL	\$ 116		\$ 130	
28"H Right (requires laminate back for back mounting)	K630PBKR	\$ 116		\$ 130	



Storage-to-Panel Bracket Kits for 24"H and 28"H Credenzas only — back mount only, painted metal					
24"H Left (does not require laminate back) (shown)	K624PBKML	\$ 105		\$ 119	
24"H Right (does not require laminate back)	K624PBKMR	\$ 105		\$ 119	
28"H Left (does not require laminate back)	K630PBKML	\$ 116		\$ 130	
28"H Right (does not require laminate back)	K630PBKMR	\$ 116		\$ 130	

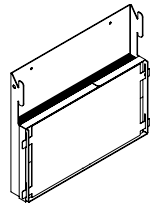

Counterweight Kit					
For 18"D units	KLCW218	\$ 169			N/A
For 24"D units	KLCW224	\$ 250			N/A



Ganging Brackets					
For Involve Footed Storage and Seat Bases	KL GK	\$ 46			N/A
For Involve Plinth Base Storage and Seat Bases	KLPGK	\$ 46			N/A



CAM Covers — matches laminate specified					
CAM Covers (20 per pack)	KLCC	\$ 14			N/A

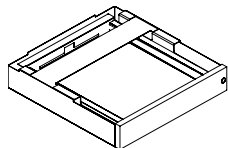

Description	Model	List Price		
		P1 Core	P2 Select	P3 Accent
Laptop Drawer - Locking, laminate front, metal case				
17 1/2"W x 18"D x 3 3/8"H (Interior 13"W x 16"D x 1 1/8"H)	U7WDA	\$ 999	\$ 1016	\$ 1032

How to specify — Select the Model Number from above.	1st Option: Laminate (Laptop drawer front if applicable): See inside front cover for finishes.	2nd Option: Edge (Laptop drawer edge if applicable): See inside front cover for finishes.	3rd Option: Paint (If laptop drawer, list exterior case color here): See inside front cover for finishes.	4th Option: Paint (Interior of laptop drawer if applicable): See inside front cover for finishes.	5th Option: Lock (if applicable): STD Standard OMT Omit (Deduct \$18)	6th Option: Lock or Tech Module Color (if applicable): EL Silver																																																								
<table border="1"> <tr><td> </td><td> </td><td> </td><td> </td><td> </td><td> </td><td> </td></tr> <tr><td> </td><td> </td><td> </td><td> </td><td> </td><td> </td><td> </td></tr> </table>															<table border="1"> <tr><td> </td><td> </td><td> </td><td> </td><td> </td><td> </td><td> </td></tr> </table>								<table border="1"> <tr><td> </td><td> </td><td> </td><td> </td><td> </td><td> </td><td> </td></tr> </table>								<table border="1"> <tr><td> </td><td> </td><td> </td><td> </td><td> </td><td> </td><td> </td></tr> </table>								<table border="1"> <tr><td> </td><td> </td><td> </td><td> </td><td> </td><td> </td><td> </td></tr> </table>								<table border="1"> <tr><td> </td><td> </td><td> </td><td> </td><td> </td><td> </td><td> </td></tr> </table>								<table border="1"> <tr><td> </td><td> </td><td> </td><td> </td><td> </td><td> </td><td> </td></tr> </table>							

Examples: K624PBKL.P7B KLCC.LM16
U7WDA.LM11EV.P27.PR6.STDEL

S Shippable by small-package carrier.

Involve® Laminate Wood Storage

Accessories

For specification information see pages 92-101.

GSA SIN 711-2

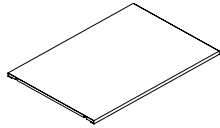

Description	Model	Core Paint			Select Paint			Accent Paint		
		P1 List Price	P2 List Price	P3 List Price	P1 List Price	P2 List Price	P3 List Price	P1 List Price	P2 List Price	P3 List Price
Metal Shelves — ½"H										
18"W x 18"D – for Units with Doors – use with KLC201818RH or LH	SH1818	\$ 119	\$ 146	\$ 168						
18"W x 24"D – for Units with Doors – use with KLT501824LBBF, KLT502424RFF, KLT651824L, KLT721824R	SH1824	\$ 133	\$ 160	\$ 182						
24"W x 24"D – for Units with Doors – use with KLT652424L or R	SH2424	\$ 138	\$ 165	\$ 187						
30"W x 15"D – use with KLBC653015A or KLBC723015A (Bookcases)	SH3015A	\$ 151	\$ 178	\$ 200						
36"W x 15"D – use with KLBC653615A or KLBC723615A (Bookcases)	SH3615A	\$ 157	\$ 184	\$ 206						
18"W x 18"D – use with K □ 241818A, K □ 281818A, K □ C271818A, K □ C351818A, K □ C421818A, K □ 243618DA, K □ 283618DA (24"H & 28"H Credenzas and Stacking Storage)	SH1818A	\$ 145	\$ 172	\$ 194						
24"W x 18"D – use with K □ 242418A, K □ 282418A, K □ C272418A, K □ C352418A, K □ C422418A (24"H & 28"H Credenzas and Stacking Storage)	SH2418A	\$ 151	\$ 178	\$ 200						
30"W x 18"D – use with K □ 243018A, K □ 283018A (24"H & 28"H Credenzas)	SH3018A	\$ 157	\$ 184	\$ 206						
36"W x 18"D – use with K □ 243618A, K □ 283618A, (24"H & 28"H Credenzas)	SH3618A	\$ 165	\$ 192	\$ 214						
48"W x 18"D – use with K □ 284818DA, K □ 424818A (28"H & 42"H Credenza)	SH4818A	\$ 179	\$ 206	\$ 228						
60"W x 18"D – use with K □ 286018DA (28"H Credenza)	SH6018A	\$ 190	\$ 217	\$ 239						
18"W x 24"D – use with K □ 241824A, K □ 281824A (28"H Credenza)	SH1824A	\$ 146	\$ 173	\$ 195						
24"W x 24"D – use with K □ 242424A, K □ 282424A (28"H Credenza)	SH2424A	\$ 165	\$ 192	\$ 214						
30"W x 24"D – use with K □ 243024A, K □ 283024A (28"H Credenza)	SH3024A	\$ 172	\$ 199	\$ 221						
36"W x 24"D – use with K □ 243624A, K □ 283624A (28"H Credenza)	SH3624A	\$ 179	\$ 206	\$ 228						
Metal Shelves — ½"H for units with sliding door										
36"W x 18"D	SH3618S	\$ 157	\$ 184	\$ 206						
36"W x 24"D	SH3624S	\$ 170	\$ 197	\$ 219						
48"W x 18"D	SH4818S	\$ 170	\$ 197	\$ 219						
48"W x 24"D	SH4824S	\$ 182	\$ 209	\$ 231						

Involve Tower Shelving

Type	Side Access	Shelf Model	Example of Model
	18"D	SH1818A	KLST502418LFF
	24"D	SH2418A	KLST572424RBBF
	Hinged Door (w/drawers)		
	All	SH1824	KLT502424LBBF
	Full Width Hinged Door		
	12"W x 18"D	SH1218	KLT421218L
	12"W x 24"D	SH1224	KLT421224R
	18"W x 24"D	SH1824	KLT651824R
	24"W x 24"D	SH2424	KLT722424L

How to specify —
Select the Model Number from above.

1st Option:
Paint Color:
C S A
See inside front cover for finishes.
No upcharge for PR6.

Example: SH1818.P7B

ALIGN METAL SPEC
ALIGN PRICING
ESSENTIALS SPEC
ESSENTIALS PRICING
VERTICALS
INVOLVE SPEC
INVOLVE PRICING
ALIGN VENEER

Involve® Laminate Wood Storage

Accessories

For specification information see pages 92-101.

GSA SIN 711-2

Description	Model	Core	Select	Accent
		Paint	Paint	Paint
		P1 List Price	P2 List Price	P3 List Price
12"D Pullout Metal Shelves — 2"H				
18"W x 12"D Pullout Shelf for 18"D Powered Credenza	KPS1812	\$ 220	\$ 252	\$ 281
24"W x 12"D Pullout Shelf for 18"D Powered Credenza	KPS2412	\$ 231	\$ 263	\$ 292
30"W x 12"D Pullout Shelf for 18"D Powered Credenza	KPS3012	\$ 252	\$ 284	\$ 313
36"W x 12"D Pullout Shelf for 18"D Powered Credenza	KPS3612	\$ 220	\$ 252	\$ 281
24"W x 12"D Pullout Shelf for 18"D x 48"W Powered Credenza w/Septum	KPSD2412	\$ 231	\$ 263	\$ 292
30"W x 12"D Pullout Shelf for 18"D x 60"W Powered Credenza w/Septum	KPSD3012	\$ 252	\$ 284	\$ 313
36"W x 12"D Pullout Shelf for 18"D x 72"W Powered Credenza w/Septum	KPSD3612	\$ 269	\$ 301	\$ 330
18"D Pullout Metal Shelves — 2"H				
18"W x 18"D Pullout Shelf	KPS1818	\$ 226	\$ 258	\$ 287
24"W x 18"D Pullout Shelf	KPS2418	\$ 237	\$ 269	\$ 298
30"W x 18"D Pullout Shelf	KPS3018	\$ 271	\$ 303	\$ 332
36"W x 18"D Pullout Shelf	KPS3618	\$ 290	\$ 322	\$ 351
24"W x 18"D Pullout Shelf for 48"W Storage w/Septum	KPSD2418	\$ 237	\$ 269	\$ 298
30"W x 18"D Pullout Shelf for 60"W Storage w/Septum	KPSD3018	\$ 271	\$ 303	\$ 332
36"W x 18"D Pullout Shelf for 72"W Storage w/Septum	KPSD3618	\$ 276	\$ 308	\$ 337
24"D Pullout Metal Shelves — 2"H				
18"W x 24"D Pullout Shelf	KPS1824	\$ 244	\$ 276	\$ 305
24"W x 24"D Pullout Shelf	KPS2424	\$ 258	\$ 290	\$ 319
30"W x 24"D Pullout Shelf	KPS3024	\$ 277	\$ 309	\$ 338
36"W x 24"D Pullout Shelf	KPS3624	\$ 298	\$ 330	\$ 359
24"W x 24"D Pullout Shelf for 48"W Storage w/Septum	KPSD2424	\$ 258	\$ 290	\$ 319
30"W x 24"D Pullout Shelf for 60"W Storage w/Septum	KPSD3024	\$ 277	\$ 309	\$ 338
36"W x 24"D Pullout Shelf for 72"W Storage w/Septum	KPSD3624	\$ 281	\$ 313	\$ 342

Note: Additional pullout shelves can only be added to box/lateral credenzas with center septum.

How to specify —
Select the Model Number from above.

1st Option:
Paint Color:
G S A
See inside front cover for finishes.
No upcharge for PR6.

_____ . _____

Example: KPSD3024.P02

ALIGN METAL SPEC
ALIGN PRICING
ESSENTIALS SPEC
ESSENTIALS PRICING
VERTICALS
INVOLVE SPEC
INVOLVE PRICING
ALIGN VENEER

Involve® Laminate Wood Storage

12"W Leg Base Towers

For specification information see pages 92-101.

GSA SIN 711-3

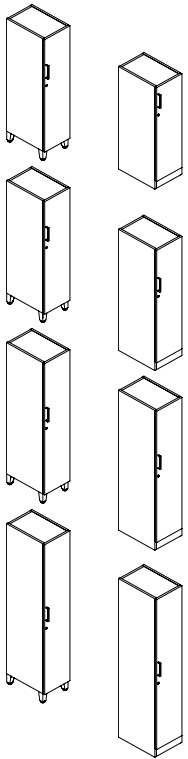

Description	Solid Color "KL" (Feet) or "KLP" (Plinth); Or prefix for Woodgrain or Two-Tone "K2T" (Feet) or "K2TP" (Plinth) Model	Lock Qty	L1 Laminate List Price	UPCHARGES*			
				L2 Laminate Case	L2 Laminate Front	L3 Laminate Case	L3 Laminate Front
42½"H Personal Towers — 12"W							
18"D Right Hinged Dr., 1 Adj. Shelf	K □ T421218R (shown)	1	\$ 1685	\$ 58	\$ 27	\$ 116	\$ 50
18"D Left Hinged Dr., 1 Adj. Shelf	K □ T421218L	1	\$ 1685	\$ 58	\$ 27	\$ 116	\$ 50
24"D Right Hinged Dr., 1 Adj. Shelf	K □ T421224R	1	\$ 1710	\$ 59	\$ 27	\$ 117	\$ 51
24"D Left Hinged Dr., 1 Adj. Shelf	K □ T421224L	1	\$ 1710	\$ 59	\$ 27	\$ 117	\$ 51
50"H Personal Towers — 12"W							
18"D Right Hinged Dr., 2 Adj. Shelves	K □ T501218R (shown)	1	\$ 1736	\$ 59	\$ 27	\$ 120	\$ 52
18"D Left Hinged Dr., 2 Adj. Shelves	K □ T501218L	1	\$ 1736	\$ 59	\$ 27	\$ 120	\$ 52
24"D Right Hinged Dr., 2 Adj. Shelves	K □ T501224R	1	\$ 1775	\$ 61	\$ 28	\$ 124	\$ 52
24"D Left Hinged Dr., 2 Adj. Shelves	K □ T501224L	1	\$ 1775	\$ 61	\$ 28	\$ 124	\$ 52
57½"H Personal Towers — 12"W							
18"D Right Hinged Dr., 2 Adj. Shelves	K □ T571218R (shown)	1	\$ 1808	\$ 62	\$ 28	\$ 126	\$ 54
18"D Left Hinged Dr., 2 Adj. Shelves	K □ T571218L	1	\$ 1808	\$ 62	\$ 28	\$ 126	\$ 54
24"D Right Hinged Dr., 2 Adj. Shelves	K □ T571224R	1	\$ 1825	\$ 62	\$ 28	\$ 126	\$ 54
24"D Left Hinged Dr., 2 Adj. Shelves	K □ T571224L	1	\$ 1825	\$ 62	\$ 28	\$ 126	\$ 54
65"H Personal Towers — 12"W							
18"D Right Hinged Dr., 2 Adj. Shelves	K □ T651218R (shown)	1	\$ 1838	\$ 63	\$ 28	\$ 128	\$ 54
18"D Left Hinged Dr., 2 Adj. Shelves	K □ T651218L	1	\$ 1838	\$ 63	\$ 28	\$ 128	\$ 54
24"D Right Hinged Dr., 2 Adj. Shelves	K □ T651224R	1	\$ 1845	\$ 63	\$ 28	\$ 128	\$ 54
24"D Left Hinged Dr., 2 Adj. Shelves	K □ T651224L	1	\$ 1845	\$ 63	\$ 28	\$ 128	\$ 54

*Upcharges are added to solid laminate list price depending on woodgrain laminate selection.

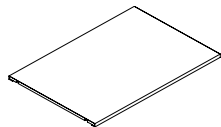

Description	Model	Core Paint List Price	Select Paint List Price	Accent Paint List Price
Metal Shelves — ½"H				
12"W x 18"D	SH1218	\$ 119	\$ 146	\$ 168
12"W x 24"D	SH1224	\$ 133	\$ 160	\$ 182

<p>How to specify — Select the Model Number from above.</p> <p>KL Feet / Solid Color KLP Plinth/ Solid Color K2T Feet / Woodgrain or Two-Tone K2TP Plinth / Woodgrain or Two-Tone</p> <p>K . </p>	<p><i>1st Option:</i> Foot Type (if applicable): TF Terrace Foot ZF Stride Foot (Add \$77)</p> <p>TF ZF </p>	<p><i>2nd Option:</i> Foot Paint Color (if applicable): C S See inside front cover for finishes. Stride is limited to PR6 Silver.</p> <p>C S </p>	<p><i>3rd Option:</i> Pull Type (if applicable): AP Arch SP Square Pull HP Straight Pull</p> <p>AP SP HP </p>	<p><i>4th Option:</i> Pull Color (if applicable): PR6 Silver</p> <p>PR6 </p>	<p><i>5th Option:</i> Metal Shelf Color: C S A See inside front cover for finishes. Add \$26 for Select P2 (except PR6) or \$48 for Accent P3 Paints.</p> <p>C S A </p>
---	--	---	---	--	---

Continued below ▼

<p><i>6th Option:</i> FSC Certified Wood (if applicable): FSC Select for FSC Certified Wood X No FSC</p> <p>FSC X </p>	<p><i>7th Option:</i> Laminate Color (if applicable): See inside front cover for finishes. (If two-tone list case color here.)</p> <p> </p>	<p><i>8th Option:</i> Matching Edge (if applicable): See inside front cover for finishes.</p> <p> </p>	<p><i>9th Option:</i> 2nd Laminate Color (Front) (if applicable): See inside front cover for finishes.</p> <p> </p>	<p><i>10th Option:</i> Matching Edge (if applicable): See inside front cover for finishes.</p> <p> </p>	<p><i>11th Option:</i> Lock (if applicable): STD Standard OMT Omit Lock Core (Deduct \$18)</p> <p>STD OMT </p>	<p><i>12th Option:</i> Lock Color (if applicable): EL Silver</p> <p>EL </p>
--	---	--	---	---	--	---

Examples: K2TT421218R.APPR6.P7D.X.LM13EY.LM15EU.STDEL
KLT501224R.SP6.P7B.FSC.LM11EV.OMT SH1218.P7D

Involve® Laminate Wood Storage

50"H Towers

For specification information see pages 92-101.

GSA SIN 711-3

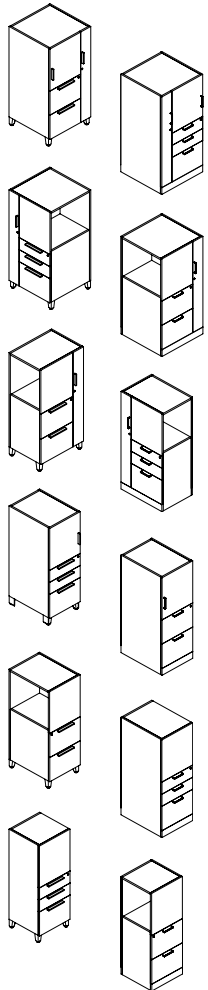

Description	Solid Color "KL" (Feet) or "KLP" (Plinth); Or prefix for Woodgrain or Two-Tone "K2T" (Feet) or "K2TP" (Plinth) Model	Lock Qty	L1 Laminate List Price	UPCHARGES*			
				L2 Laminate Case	L2 Laminate Front	L3 Laminate Case	L3 Laminate Front
50"H Personal Hinged Door Towers — 24"W x 24"D							
Wardrobe Right / File/File (shown)	K <input type="checkbox"/> T502424RFF	2	\$ 2703	\$ 94	\$ 41	\$ 189	\$ 80
Wardrobe Left / File/File	K <input type="checkbox"/> T502424LFF	2	\$ 2703	\$ 94	\$ 41	\$ 189	\$ 80
Wardrobe Right / Box/Box/File	K <input type="checkbox"/> T502424RBBF	2	\$ 3032	\$ 105	\$ 45	\$ 212	\$ 94
Wardrobe Left / Box/Box/File (shown)	K <input type="checkbox"/> T502424LBBF	2	\$ 3032	\$ 105	\$ 45	\$ 212	\$ 94
50"H Personal Side Access Towers — 24"W x 24"D							
Wardrobe Right / File/File (shown)	K <input type="checkbox"/> ST502424RFF	2	\$ 2703	\$ 94	\$ 41	\$ 189	\$ 80
Wardrobe Left / File/File	K <input type="checkbox"/> ST502424LFF	2	\$ 2703	\$ 94	\$ 41	\$ 189	\$ 80
Wardrobe Right / Box/Box/File	K <input type="checkbox"/> ST502424RBBF	2	\$ 3032	\$ 105	\$ 45	\$ 212	\$ 91
Wardrobe Left / Box/Box/File (shown)	K <input type="checkbox"/> ST502424LBBF	2	\$ 3032	\$ 105	\$ 45	\$ 212	\$ 91
50"H Personal Side Access Towers — 24"W x 18"D							
Wardrobe Right / File/File (shown)	K <input type="checkbox"/> ST502418RFF	2	\$ 2439	\$ 84	\$ 37	\$ 170	\$ 75
Wardrobe Left / File/File	K <input type="checkbox"/> ST502418LFF	2	\$ 2439	\$ 84	\$ 37	\$ 170	\$ 75
Wardrobe Right / Box/Box/File	K <input type="checkbox"/> ST502418RBBF	2	\$ 2769	\$ 95	\$ 42	\$ 192	\$ 82
Wardrobe Left / Box/Box/File (shown)	K <input type="checkbox"/> ST502418LBBF	2	\$ 2769	\$ 95	\$ 42	\$ 192	\$ 82
50"H Personal Hinged Door Towers — 18"W x 24"D							
RH Hinged Door/File/File (shown)	K <input type="checkbox"/> T501824RFF	1	\$ 2486	\$ 86	\$ 37	\$ 171	\$ 75
LH Hinged Door/File/File	K <input type="checkbox"/> T501824LFF	1	\$ 2486	\$ 86	\$ 37	\$ 171	\$ 75
RH Hinged Door/Box/Box/File	K <input type="checkbox"/> T501824RBBF	1	\$ 2703	\$ 93	\$ 39	\$ 188	\$ 84
LH Hinged Door/Box/Box/File (shown)	K <input type="checkbox"/> T501824LBBF	1	\$ 2703	\$ 93	\$ 39	\$ 188	\$ 84
50"H Personal Side Access Towers — 18"W x 24"D							
RH Side Access/File/File (shown)	K <input type="checkbox"/> ST501824RFF	1	\$ 2486	\$ 86	\$ 37	\$ 171	\$ 75
LH Side Access/File/File	K <input type="checkbox"/> ST501824LFF	1	\$ 2486	\$ 86	\$ 37	\$ 171	\$ 75
RH Side Access/Box/Box/File	K <input type="checkbox"/> ST501824RBBF	1	\$ 2703	\$ 93	\$ 37	\$ 188	\$ 73
LH Side Access/Box/Box/File (shown)	K <input type="checkbox"/> ST501824LBBF	1	\$ 2703	\$ 93	\$ 37	\$ 188	\$ 73
50"H Personal Side Access Towers — 18"W x 18"D							
RH Side Access/File/File (shown)	K <input type="checkbox"/> ST501818RFF	1	\$ 2320	\$ 79	\$ 34	\$ 160	\$ 66
LH Side Access/File/File	K <input type="checkbox"/> ST501818LFF	1	\$ 2320	\$ 79	\$ 34	\$ 160	\$ 66
RH Side Access/Box/Box/File	K <input type="checkbox"/> ST501818RBBF	1	\$ 2525	\$ 89	\$ 37	\$ 175	\$ 73
LH Side Access/Box/Box/File (shown)	K <input type="checkbox"/> ST501818LBBF	1	\$ 2525	\$ 89	\$ 37	\$ 175	\$ 73

*Upcharges are added to laminate list price depending on woodgrain laminate selection.

<p>How to specify —</p> <p>Select the Model Number from above.</p> <p>KL Feet / Solid Color KLP Plinth/ Solid Color K2T Feet / Woodgrain or Two-Tone K2TP Plinth / Woodgrain or Two-Tone</p> <p>K . </p>	<p>1st Option:</p> <p>Foot Type (if applicable):</p> <p>TF Terrace Foot ZF Stride Foot (Add \$77)</p> <p> </p>	<p>2nd Option:</p> <p>Foot Paint (if applicable):</p> <p><input checked="" type="radio"/> <input checked="" type="radio"/></p> <p>See inside front cover for finishes. Stride is limited to PR6 Silver.</p> <p>P .</p>	<p>3rd Option:</p> <p>Pull Type:</p> <p>AP Arch SP Square Pull HP Straight Pull</p> <p> </p>	<p>4th Option:</p> <p>Pull Color:</p> <p>PR6 Silver</p> <p>P R 6 .</p>	<p>5th Option:</p> <p>Metal Shelf Color:</p> <p><input checked="" type="radio"/> <input checked="" type="radio"/> <input checked="" type="radio"/></p> <p>See inside front cover for finishes. Add \$26 for Select P2 (except PR6) or \$48 for Accent P3 Paints.</p> <p> .</p>
--	--	--	--	--	---

Continued below ▼

<p>6th Option:</p> <p>FSC Certified Wood:</p> <p>FSC Select for FSC Certified Wood X No FSC</p> <p> .</p>	<p>7th Option:</p> <p>Laminate Color:</p> <p>See inside front cover for finishes.</p> <p>(If two-tone list case color here.)</p> <p> </p>	<p>8th Option:</p> <p>Matching Edge:</p> <p>See inside front cover for finishes.</p> <p> .</p>	<p>9th Option:</p> <p>2nd Laminate Color (Front) (if applicable):</p> <p>See inside front cover for finishes.</p> <p> .</p>	<p>10th Option:</p> <p>Matching Edge (if applicable):</p> <p>See inside front cover for finishes.</p> <p> .</p>	<p>11th Option:</p> <p>Lock Option:</p> <p>STD Standard OMT Omit Lock Core (deduct \$18 per lock)</p> <p> </p>	<p>12th Option:</p> <p>Lock Color (if applicable):</p> <p>EL Silver</p> <p>E L </p>
--	---	---	--	--	--	--

Examples: K2TST502424RFF.TFPO8.APPR6.P7D.X.LWCWEDCW.LWCWEDCW.STDEL

KLST502424RFF.ZFPR6.SPPR6.P7B.FSC.LM11EV.OMT

ALIGN METAL SPEC
ALIGN PRICING
ESSENTIALS SPEC
ESSENTIALS PRICING
VERTICALS
INVOLVE SPEC
INVOLVE PRICING
ALIGN VENEER

Involve® Laminate Wood Storage

57½"H Towers

For specification information see pages 92-101.

GSA SIN 711-3

ALIGN METAL SPEC

ALIGN PRICING

ESSENTIALS SPEC

ESSENTIALS PRICING

VERTICALS

INVOLVE SPEC

INVOLVE PRICING

ALIGN VENEER

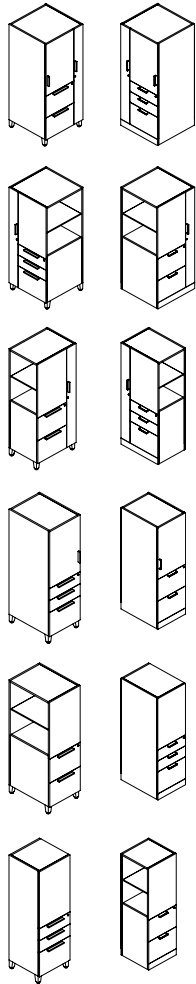

Description	Solid Color "KL" (Feet) or "KLP" (Plinth); Or prefix for Woodgrain or Two-Tone "K2T" (Feet) or "K2TP" (Plinth) Model	Lock Qty	L1 Laminate List Price	UPCHARGES*			
				L2 Laminate Case	L2 Laminate Front	L3 Laminate Case	L3 Laminate Front
57½"H Personal Hinged Door Towers — 24"W x 24"D							
Wardrobe Right / File/File (shown)	K □ T572424RFF	2	\$ 2835	\$ 94	\$ 41	\$ 189	\$ 86
Wardrobe Left / File/File	K □ T572424LFF	2	\$ 2835	\$ 94	\$ 41	\$ 189	\$ 86
Wardrobe Right / Box/Box/File	K □ T572424RBBF	2	\$ 3163	\$ 108	\$ 46	\$ 220	\$ 94
Wardrobe Left / Box/Box/File (shown)	K □ T572424LBBF	2	\$ 3163	\$ 108	\$ 46	\$ 220	\$ 94
57½"H Personal Side Access Towers — 24"W x 24"D							
Wardrobe Right / File/File (shown)	K □ ST572424RFF	2	\$ 2835	\$ 94	\$ 41	\$ 189	\$ 86
Wardrobe Left / File/File	K □ ST572424LFF	2	\$ 2835	\$ 94	\$ 41	\$ 189	\$ 86
Wardrobe Right / Box/Box/File	K □ ST572424RBBF	2	\$ 3163	\$ 108	\$ 46	\$ 220	\$ 94
Wardrobe Left / Box/Box/File (shown)	K □ ST572424LBBF	2	\$ 3163	\$ 108	\$ 46	\$ 220	\$ 94
57½"H Personal Side Access Towers — 24"W x 18"D							
Wardrobe Right / File/File (shown)	K □ ST572418RFF	2	\$ 2570	\$ 84	\$ 38	\$ 170	\$ 75
Wardrobe Left / File/File	K □ ST572418LFF	2	\$ 2570	\$ 84	\$ 38	\$ 170	\$ 75
Wardrobe Right / Box/Box/File	K □ ST572418RBBF	2	\$ 2900	\$ 100	\$ 43	\$ 201	\$ 87
Wardrobe Left / Box/Box/File (shown)	K □ ST572418LBBF	2	\$ 2900	\$ 100	\$ 43	\$ 201	\$ 87
57½"H Personal Hinged Door Towers — 18"W x 24"D							
RH Hinged Door/File/File (shown)	K □ T571824RFF	1	\$ 2616	\$ 91	\$ 38	\$ 180	\$ 75
LH Hinged Door/File/File	K □ T571824LFF	1	\$ 2616	\$ 91	\$ 38	\$ 180	\$ 75
RH Hinged Door/Box/Box/File	K □ T571824RBBF	1	\$ 2835	\$ 98	\$ 42	\$ 196	\$ 84
LH Hinged Door/Box/Box/File (shown)	K □ T571824LBBF	1	\$ 2835	\$ 98	\$ 42	\$ 196	\$ 84
57½"H Personal Side Access Towers — 18"W x 24"D							
RH Side Access/File/File (shown)	K □ ST571824RFF	1	\$ 2616	\$ 91	\$ 38	\$ 180	\$ 75
LH Side Access/File/File	K □ ST571824LFF	1	\$ 2616	\$ 91	\$ 38	\$ 180	\$ 75
RH Side Access/Box/Box/File	K □ ST571824RBBF	1	\$ 2835	\$ 98	\$ 42	\$ 196	\$ 84
LH Side Access/Box/Box/File (shown)	K □ ST571824LBBF	1	\$ 2835	\$ 98	\$ 42	\$ 196	\$ 84
57½"H Personal Side Access Towers — 18"W x 18"D							
RH Side Access/File/File (shown)	K □ ST571818RFF	1	\$ 2452	\$ 86	\$ 35	\$ 170	\$ 69
LH Side Access/File/File	K □ ST571818LFF	1	\$ 2452	\$ 86	\$ 35	\$ 170	\$ 69
RH Side Access/Box/Box/File	K □ ST571818RBBF	1	\$ 2656	\$ 92	\$ 39	\$ 186	\$ 77
LH Side Access/Box/Box/File (shown)	K □ ST571818LBBF	1	\$ 2656	\$ 92	\$ 39	\$ 186	\$ 77

*Upcharges are added to laminate list price depending on woodgrain laminate selection.

<p>How to specify —</p> <p>Select the Model Number from above.</p> <p>KL Feet / Solid Color KLP Plinth/ Solid Color K2T Feet / Woodgrain or Two-Tone K2TP Plinth / Woodgrain or Two-Tone</p>	<p>1st Option:</p> <p>Foot Type (if applicable):</p> <p>TF Terrace Foot ZF Stride Foot (Add \$77)</p>	<p>2nd Option:</p> <p>Foot Paint (if applicable):</p> <p>ⓐ ⓑ</p> <p>See inside front cover for finishes. Stride is limited to PR6 Silver.</p>	<p>3rd Option:</p> <p>Pull Type:</p> <p>AP Arch SP Square Pull HP Straight Pull</p>	<p>4th Option:</p> <p>Pull Color:</p> <p>PR6 Silver</p>	<p>5th Option:</p> <p>Metal Shelf Color:</p> <p>Ⓒ Ⓓ Ⓔ</p> <p>See inside front cover for finishes. Add \$26 for Select P2 (except PR6) or \$48 for Accent P3 Paints.</p>
K .		P .		P R 6 .	.

Continued below ▼

<p>6th Option:</p> <p>FSC Certified Wood:</p> <p>FSC Select for FSC Certified Wood X No FSC</p>	<p>7th Option:</p> <p>Laminate Color:</p> <p>See inside front cover for finishes. (If two-tone list case color here.)</p>	<p>8th Option:</p> <p>Matching Edge:</p> <p>See inside front cover for finishes.</p>	<p>9th Option:</p> <p>2nd Laminate Color (Front) (if applicable):</p> <p>See inside front cover for finishes.</p>	<p>10th Option:</p> <p>Matching Edge (if applicable):</p> <p>See inside front cover for finishes.</p>	<p>11th Option:</p> <p>Lock Option:</p> <p>STD Standard OMT Omit Lock Core (deduct \$18 per lock)</p>	<p>12th Option:</p> <p>Lock Color (if applicable):</p> <p>EL Silver</p>
.		.		.		E L

Examples: K2ST571824RFF.TFPQ8.APPR6.P7D.X.LWCWEDCW.LWCWEDCW.STDEL
KLT571824RFF.ZFPR6.SPPR6.FSC.LM11EV.OMT

Involve® Laminate Wood Storage

65"H Towers

For specification information see pages 92-101.

GSA SIN 711-3

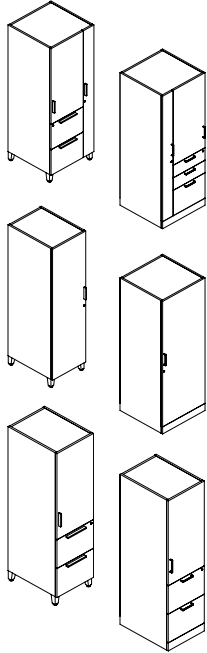

Description	Solid Color "KL" (Feet) or "KLP" (Plinth); Or prefix for Woodgrain or Two-Tone "K2T" (Feet) or "K2TP" (Plinth) Model	Lock Qty	L1 Laminate List Price	UPCHARGES*			
				L2 Laminate Case	L2 Laminate Front	L3 Laminate Case	L3 Laminate Front
65"H Personal Towers — 24"W x 24"D							
Wardrobe Right / Hgd Door/File/File	K □ T652424RFF	2	\$ 3019	\$ 104	\$ 44	\$ 211	\$ 91
Wardrobe Left / Hgd Door/File/File	K □ T652424LFF	2	\$ 3019	\$ 104	\$ 44	\$ 211	\$ 91
Wardrobe Right / Hgd Dr/Box/Box/File	K □ T652424RBBF	2	\$ 3362	\$ 115	\$ 50	\$ 234	\$ 100
Wardrobe Left / Hgd Dr/Box/Box/File	K □ T652424LBBF	2	\$ 3362	\$ 115	\$ 50	\$ 234	\$ 100
65"H Personal Towers — 24"W x 24"D							
Right Hinged Door, 2 Adj. Shelves	K □ T652424R	1	\$ 1979	\$ 66	\$ 30	\$ 138	\$ 58
Left Hinged Door, 2 Adj. Shelves	K □ T652424L	1	\$ 1979	\$ 66	\$ 30	\$ 138	\$ 58
65"H Personal Towers — 18"W x 24"D							
Right Hinged Door, 2 Adj. Shelves	K □ T651824R	1	\$ 1845	\$ 63	\$ 29	\$ 128	\$ 54
Left Hinged Door, 2 Adj. Shelves	K □ T651824L	1	\$ 1845	\$ 63	\$ 29	\$ 128	\$ 54
65"H Personal Hinged Door Towers — 18"W x 24"D							
RH Hinged Door/File/File	K □ T651824RFF	1	\$ 2802	\$ 96	\$ 41	\$ 193	\$ 82
LH Hinged Door/File/File	K □ T651824LFF	1	\$ 2802	\$ 96	\$ 41	\$ 193	\$ 82
RH Hinged Door/Box/Box/File	K □ T651824RBBF	1	\$ 2900	\$ 100	\$ 43	\$ 201	\$ 91
LH Hinged Door/Box/Box/File	K □ T651824LBBF	1	\$ 2900	\$ 100	\$ 43	\$ 201	\$ 91

How to specify — Select the Model Number from above. KL Feet / Solid Color KLP Plinth/ Solid Color K2T Feet / Woodgrain or Two-Tone K2TP Plinth / Woodgrain or Two-Tone	1st Option: Foot Type (if applicable): TF Terrace Foot ZF Stride Foot (Add \$77)	2nd Option: Foot Paint (if applicable): C S See inside front cover for finishes. Stride foot is limited to PR6 Silver.	3rd Option: Pull Type (if applicable): AP Arch SP Square Pull HP Straight Pull	4th Option: Pull Color (if applicable): PR6 Silver	5th Option: Metal Shelf Color (if applicable): C S A See inside front cover for finishes. Add \$26 for Select P2 (except PR6) or \$48 for Accent P3 Paints.
K	P	P R 6

6th Option: FSC Certified Wood (if applicable): FSC Select for FSC Certified Wood X No FSC	7th Option: Laminate Color (if applicable): See inside front cover for finishes. (If two-tone list case color here.)	8th Option: Matching Edge (if applicable): See inside front cover for finishes.	9th Option: 2nd Laminate Color (Front) (if applicable): See inside front cover for finishes.	10th Option: Matching Edge (if applicable): See inside front cover for finishes.	11th Option: Lock Option (if applicable): STD Standard OMT Omit Lock Core (deduct \$18 per lock)	12th Option: Lock Color (if applicable): EL Silver
.	E L

Examples: K2TT652424RFF.TFPQ8.APPR6.P7D.X.LWCWEDCW.LWCWEDCW.STDEL
 KLT652424RFF.ZFPR6.SP6.P7B.FSC.LM11EV.OMT

Involve® Laminate Wood Storage

72½"H Towers

For specification information see pages 92-101.

GSA SIN 711-3

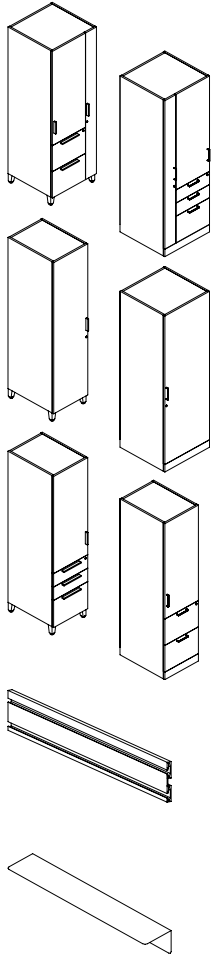

Description	Solid Color "KL" (Feet) or "KLP" (Plinth); Or prefix for Woodgrain or Two-Tone "K2T" (Feet) or "K2TP" (Plinth) Model	Lock Qty	L1 Laminate List Price	UPCHARGES*			
				L2 Laminate Case	L2 Laminate Front	L3 Laminate Case	L3 Laminate Front
72½"H Personal Towers — 24"W x 24"D							
Wardrobe Right / Hgd Door/File/File	K □ T722424RFF	2	\$ 3284	\$ 113	\$ 113	\$ 228	\$ 228
Wardrobe Left / Hgd Door/File/File	K □ T722424LFF	2	\$ 3284	\$ 113	\$ 113	\$ 228	\$ 228
Wardrobe Right / Hgd Dr/Box/Box/File	K □ T722424RBBF	2	\$ 3625	\$ 127	\$ 53	\$ 253	\$ 107
Wardrobe Left / Hgd Dr/Box/Box/File	K □ T722424LBBF	2	\$ 3625	\$ 127	\$ 53	\$ 253	\$ 107
72½"H Personal Towers — 24"W x 24"D							
Right Hinged Door, 2 Adj. Shelves	K □ T722424R	1	\$ 2077	\$ 69	\$ 32	\$ 144	\$ 61
Left Hinged Door, 2 Adj. Shelves	K □ T722424L	1	\$ 2077	\$ 69	\$ 32	\$ 144	\$ 61
72½"H Personal Towers — 18"W x 24"D							
Right Hinged Door, 2 Adj. Shelves	K □ T721824R	1	\$ 1945	\$ 66	\$ 30	\$ 135	\$ 57
Left Hinged Door, 2 Adj. Shelves	K □ T721824L	1	\$ 1945	\$ 66	\$ 30	\$ 135	\$ 57
72½"H Personal Hinged Door Towers — 18"W x 24"D							
RH Hinged Door/File/File (shown)	K □ T721824RFF	1	\$ 3058	\$ 105	\$ 44	\$ 213	\$ 91
LH Hinged Door/File/File	K □ T721824LFF	1	\$ 3058	\$ 105	\$ 44	\$ 213	\$ 91
RH Hinged Door/Box/Box/File	K □ T721824RBBF	1	\$ 3163	\$ 108	\$ 46	\$ 220	\$ 94
LH Hinged Door/Box/Box/File	K □ T721824LBBF	1	\$ 3163	\$ 108	\$ 46	\$ 220	\$ 94

*Upcharges are added to laminate list price depending on woodgrain laminate selection.

Tower Rail (supports worksurface on side of tower — requires rail bracket kit)

18"W Tower Rail for 18"D Tower	K6TR18	1	\$ 113	Select paint upcharge \$7 (except PR6)			
24"W Tower Rail for 24"D Tower	Z6TR24		\$ 126	Select paint upcharge \$15 (except PR6)			
Rail Bracket Kit for Worksurface (PR6 Silver only)	Z6RBK		\$ 60				

"L" Tower Bracket — for Wood Towers

"L" Tower Bracket for 18"D or 24"D Tower	Z6LB		\$ 48	Select paint upcharge \$14 (except PR6)			
--	------	--	-------	---	--	--	--

Shippable by small-package carrier.

How to specify — Select the Model Number from above. KL Feet / Solid Color KLP Plinth/ Solid Color K2T Feet / Woodgrain or Two-Tone K2TP Plinth / Woodgrain or Two-Tone	1st Option: Foot Type (if applicable): TF Terrace Foot ZF Stride Foot (Add \$77)	2nd Option: Foot, Rail, or Bracket Paint Color (if applicable): See inside front cover for finishes. Stride foot is limited to PR6 Silver. Add \$__ for Select Paint on rail or bracket (except PR6).	3rd Option: Pull Type (if applicable): AP Arch SP Square Pull HP Straight Pull	4th Option: Pull Color (if applicable): PR6 Silver	5th Option: Metal Shelf Color (if applicable): See inside front cover for finishes. Add \$26 for Select P2 (except PR6) or \$48 for Accent P3 Paints.
_____ . _____	_____	P _____ . _____	_____	P R 6 . _____	_____ . _____

Continued below ▼

6th Option: FSC Certified Wood (if applicable): FSC Select for FSC Certified Wood X No FSC	7th Option: Laminate Color (if applicable): See inside front cover for finishes. (If two-tone list case color here.)	8th Option: Matching Edge (if applicable): See inside front cover for finishes.	9th Option: 2nd Laminate Color (Front) (if applicable): See inside front cover for finishes.	10th Option: Matching Edge (if applicable): See inside front cover for finishes.	11th Option: Lock Option (if applicable): STD Standard OMT Omit Lock Core (deduct \$18 per lock)	12th Option: Lock Color (if applicable): EL Silver
_____ . _____	_____	_____ . _____	_____	_____ . _____	_____	E L _____

Examples: K2TT721824RFF.TFPQ8.APPR6.P7D.X.LWCWEDCW.LWCWEDCW.STDEL
 KL721824RFF.ZFPR6.SP7B.FSC.LM11EV.OMT K6TR18.P7B

Involve[®] Laminate Wood Storage

Stacking Storage

For specification information see pages 92-101.

GSA SIN 711-1

Description	Solid Color "KL" or "K2T" for Woodgrain or Two-Tone Model	L1 Laminate List Price	UPCHARGES*			
			L2 Laminate Case	L2 Laminate Front	L3 Laminate Case	L3 Laminate Front
20"H Stacking Storage — 18"D						
18"W Right Hinged Door (shown)	K □ C201818RH	\$ 1083	\$ 38	\$ 17	\$ 75	\$ 33
18"W Left Hinged Door	K □ C201818LH	\$ 1083	\$ 38	\$ 17	\$ 75	\$ 33
18"W Open (shown)	K □ C201818A	\$ 990	\$ 34		\$ 66	
24"W Open	K □ C202418A	\$ 1031	\$ 35		\$ 68	
27½"H Stacking Storage — 18"D with 1 adjustable metal shelf						
18"W Right Hinged Door (shown)	K □ C271818RH	\$ 1169	\$ 41	\$ 18	\$ 80	\$ 35
18"W Left Hinged Door	K □ C271818LH	\$ 1169	\$ 41	\$ 18	\$ 80	\$ 35
18"W Open (shown)	K □ C271818A	\$ 1078	\$ 37		\$ 73	
24"W Open	K □ C272418A	\$ 1120	\$ 38		\$ 76	
35"H Stacking Storage — 18"D with 1 adjustable metal shelf						
18"W Right Hinged Door (shown)	K □ C351818RH	\$ 1257	\$ 44	\$ 20	\$ 87	\$ 37
18"W Left Hinged Door	K □ C351818LH	\$ 1257	\$ 44	\$ 20	\$ 87	\$ 37
18"W Open (shown)	K □ C351818A	\$ 1164	\$ 39		\$ 79	
24"W Open	K □ C352418A	\$ 1210	\$ 42		\$ 84	
42½"H Stacking Storage — 18"D with 2 adjustable metal shelves						
18"W Right Hinged Door (shown)	K □ C421818RH	\$ 1337	\$ 47	\$ 21	\$ 93	\$ 39
18"W Left Hinged Door	K □ C421818LH	\$ 1337	\$ 47	\$ 21	\$ 93	\$ 39
18"W Open (shown)	K □ C421818A	\$ 1238	\$ 42		\$ 85	
24"W Open	K □ C422418A	\$ 1288	\$ 44		\$ 89	

*Upcharges are added to solid laminate list price depending on woodgrain laminate selection.

<p>How to specify —</p> <p>Select the Model Number from above.</p> <p>KL prefix for case/front with same Solid Color Laminate</p> <p>K2T prefix for any Woodgrain or Two-Tone Laminate</p>	<p>1st Option:</p> <p>Pull Type (if applicable):</p> <p>AP Arch</p> <p>SP Square Pull</p> <p>HP Straight Pull</p>	<p>2nd Option:</p> <p>Pull Color (if applicable):</p> <p>PR6 Silver</p>	<p>3rd Option:</p> <p>Metal Shelf Color (if applicable):</p> <p>C S A</p> <p>See inside front cover for finishes. Add \$26 for Select P2 (except PR6) or \$48 for Accent P3 Paints.</p>	<p>4th Option:</p> <p>FSC Certified Wood:</p> <p>FSC Select for FSC Certified Wood</p> <p>X No FSC</p>
K .		P R 6

Continued below ▼

<p>5th Option:</p> <p>Laminate Color:</p> <p>See inside front cover for finishes.</p> <p>(If two-tone list case color here.)</p>	<p>6th Option:</p> <p>Matching Edge:</p> <p>See inside front cover for finishes.</p>	<p>7th Option:</p> <p>2nd Laminate Color (Front) (if applicable):</p> <p>See inside front cover for finishes.</p>	<p>8th Option:</p> <p>Matching Edge (if applicable):</p> <p>See inside front cover for finishes.</p>
.	.	.	.

Examples: K2TC271818RH.APPR6.P7D.X.LWCWEDCW.LWCWEDCW
KLC201818A.P7B.FSC.LM11EV

Involve® Laminate Wood Storage

Stanchions

For specification information see pages 92-101.

GSA SIN 711-1

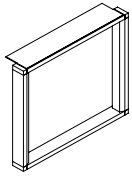

Description	Model	Core Paint		Select Paint	
		P1 List Price	P2 List Price	P1 List Price	P2 List Price
Overhead Stanchions — painted metal for use with 24"H credenzas					
11"H x 15"D Non-handed	K6OS1115L	\$ 360		\$ 383	
11"H x 18"D Non-handed	K6OS1118L	\$ 372		\$ 395	
11"H x 7½"D Mid	K6OS1107	\$ 354		\$ 377	
18"H x 15"D Non-handed	K6OS1815L	\$ 375		\$ 398	
18"H x 7½"D Mid	K6OS1807	\$ 365		\$ 388	
26"H x 15"D Non-handed	K6OS2615L	\$ 403		\$ 426	
26"H x 7½"D Mid	K6OS2607	\$ 392		\$ 415	

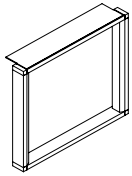

Overhead Stanchions — painted metal for use with 28"H credenzas					
5"H x 15"D Non-handed	K6OS515L	\$ 350		\$ 373	
5"H x 18"D Non-handed	K6OS518L	\$ 356		\$ 379	
12"H x 15"D Non-handed	K6OS1215L	\$ 360		\$ 383	
12"H x 18"D Non-handed	K6OS1218L	\$ 372		\$ 395	
12"H x 7½"D Mid	K6OS1207	\$ 354		\$ 377	
19¼"H x 15"D Non-handed	K6OS1915L	\$ 375		\$ 398	
19¼"H x 7½"D Mid	K6OS1907	\$ 365		\$ 388	
27"H x 15"D Non-handed	K6OS2715L	\$ 403		\$ 426	
27"H x 7½"D Mid	K6OS2707	\$ 392		\$ 415	

Tower-to-Overhead Bracket — for use with wood overhead cabinets

Attachment Bracket	K6TBK	\$ 84	\$ 98
--------------------	-------	-------	-------

Note: No upcharge for PR6 Silver paint on Involve.

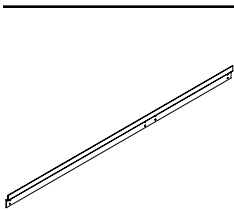

Description	Model	List Price
Horizontal Wall-Mount Brackets — for use with wood overhead cabinets		
24"W	YWC24Z	\$ 68
30"W	YWC30Z	\$ 79
36"W	YWC36Z	\$ 86
42"W	YWC42Z	\$ 95
48"W	YWC48Z	\$ 104
60"W	YWC60Z	\$ 129

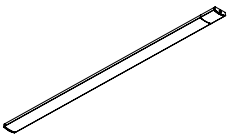

Undercabinet LED Lights (white end caps)		
17" Undercabinet LED Tasklight	ALED17U	\$ 595
31" Undercabinet LED Tasklight	ALED31U	\$ 890

Additional LED components available, see Systems price list.

How to specify —
Select the Model Number from above.

1st Option:
Paint
(if applicable):



See inside front cover for finishes.

Note: No upcharge for PR6 Silver paint on Involve.

Examples: K6OS518L.P7B YWC24Z ALED17U

Shippable by small-package carrier.

Involve® Laminate Wood Storage

Overhead Backs

For specification information see pages 92-101. Woodgrain laminate not available on 72"W-96"W.

GSA SIN 711-1



Description	Model	L1 Laminate List Price	UPCHARGES*	
			L2 Laminate	L3 Laminate
Finished Backs for Overheads — 15"H for use in single-sided applications				
30"W	KLBP1530 <input type="checkbox"/>	\$ 752	\$ 36	\$ 72
36"W	KLBP1536 <input type="checkbox"/>	\$ 756	\$ 37	\$ 73
42"W	KLBP1542 <input type="checkbox"/>	\$ 775	\$ 37	\$ 75
48"W	KLBP1548 <input type="checkbox"/>	\$ 780	\$ 38	\$ 76
60"W	KLBP1560 <input type="checkbox"/>	\$ 826	\$ 39	\$ 79
72"W	KLBP1572	\$ 941	N/A	N/A
84"W	KLBP1584	\$ 1034	N/A	N/A
96"W	KLBP1596	\$ 1155	N/A	N/A

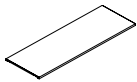

Description	Model	List Price	UPCHARGES*
Metal Shelves for 22½"H Overhead Storage with Doors on page 137 — 15"D			
Shelf for 24"W	SHOC2415	\$ 113	Add \$27 for Select (except PR6) or \$49 for Accent paint upcharge per shelf.
Shelf for 30"W	SHOC3015	\$ 119	
Shelf for 36"W	SHOC3615	\$ 127	
Shelf for 42"W	SHOC4215	\$ 133	
Shelf for 48"W	SHOC4815	\$ 138	
Shelf for 60"W	SHOC6015	\$ 164	

*Upcharges are added to solid laminate list price depending on woodgrain laminate selection.

<p>How to specify — Select the Model Number from above.</p>	<p>1st Option: Laminate Color for Overhead Finished Back (if applicable): See inside front cover for finishes.</p>	<p>2nd Option: Matching Laminate Edge for Overhead Finished Back (if applicable): See inside front cover for finishes.</p>
--	--	--

Example: KLBP1530.LM15EU

<p>How to specify — Metal Shelves — Select the Model Number from above.</p>	<p>1st Option: Paint: <input type="radio"/> C <input type="radio"/> S <input type="radio"/> A See inside front cover for finishes.</p> <p>Add \$27 for Select (except PR6) or \$49 Accent Paints.</p>
---	---

Example: SHOC2415.P7B

Shippable by small-package carrier.

Involve® Laminate Wood Storage

Tackboards

For specification information see pages 92-101. Woodgrain laminate not available on 72"W-96"W.

GSA SIN 711-1

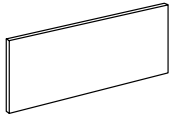

Description	Model	List Price				
		Grade A	Grade B	Grade C	Grade D	Grade E
Tackboards for 35"H Hutches						
48"W	K6TB3548T (shown)	\$ 467	\$ 513	\$ 559	\$ 605	\$ 651
60"W	K6TB3560T	\$ 527	\$ 579	\$ 631	\$ 683	\$ 735
66"W	K6TB3566T	\$ 542	\$ 595	\$ 649	\$ 703	\$ 757
72"W	K6TB3572T	\$ 602	\$ 662	\$ 721	\$ 780	\$ 839
84"W	K6TB3584T	\$ 662	\$ 727	\$ 792	\$ 857	\$ 922
Tackboards for 42½"H Hutches						
48"W	K6TB4248T (shown)	\$ 491	\$ 539	\$ 587	\$ 635	\$ 683
60"W	K6TB4260T	\$ 553	\$ 607	\$ 662	\$ 717	\$ 772
66"W	K6TB4266T	\$ 570	\$ 627	\$ 682	\$ 737	\$ 792
72"W	K6TB4272T	\$ 633	\$ 695	\$ 757	\$ 819	\$ 881
84"W	K6TB4284T	\$ 694	\$ 763	\$ 830	\$ 897	\$ 964

*Upcharges are added to solid laminate list price depending on woodgrain laminate selection.

<p>How to specify — Select the Model Number from above.</p>	<p>1st Option: Paint Color for Tackboard Frame (if applicable):</p> <p>C S</p> <p>See inside front cover for finishes. For Select P2 Paints add \$26 (except PR6).</p>	<p>2nd Option: Panel Fabric for Hutch Tackboard (if applicable):</p> <p>See inside front cover for finishes.</p>
--	---	--

Examples: K6TB3548T.P02.APN917

S Shippable by small-package carrier.

Involve® Worksurfaces

Primary, Taper and EZ View

Laminate

For specification information see pages 102-103. For additional worksurface sizes reference the Stride® or Terrace® worksurface sections.
For non-standard worksurface sizes see 9120 Program in any Systems price book.

GSA SIN 711-1

Description	Laminate w/Flat Edge Model	Laminate w/Rabbit Edge Model	Laminate w/Flat Edge			Laminate w/Rabbit Edge		
			L1 List Price	L2 List Price	L3 List Price	L1 List Price	L2 List Price	L3 List Price
18"D Primary Worksurfaces								
48"W	T51848S	ZR51848S	\$ 329	\$ 345	\$ 362	\$ 566	\$ 595	\$ 621
54"W	T51854S	N/A	\$ 355	\$ 374	\$ 391	—	—	—
60"W	T51860S	N/A	\$ 404	\$ 426	\$ 444	—	—	—
72"W	T51872S	N/A	\$ 456	\$ 480	\$ 501	—	—	—

Notes: 1) Add Suffix "N" to a model number for no grommets, no upcharge. Examples: T51848SN, TR51848SN
2) Add Suffix "S" for scallop wire management detail for flat edge models only — no upcharge. Examples: T51848SS, TR51848SS

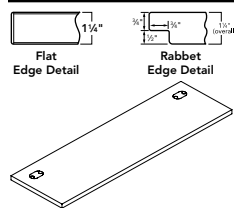

18"D Primary Worksurface

Description	Laminate w/Flat Edge Model	Laminate w/Rabbit Edge Model	L1 List Price	L2 List Price	L3 List Price	L1 List Price	L2 List Price	L3 List Price
72"W	T51872CS	ZR51872CS	\$ 478	\$ 504	\$ 525	—	—	—
84"W	T51884CS	ZR51884CS	\$ 651	\$ 684	\$ 715	—	—	—

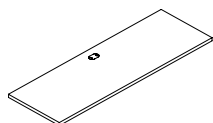

Specify Grommet Location

24"D Primary Worksurface

Description	Laminate w/Flat Edge Model	Laminate w/Rabbit Edge Model	L1 List Price	L2 List Price	L3 List Price	L1 List Price	L2 List Price	L3 List Price
72"W	T52472CS	ZR52472CS	\$ 518	\$ 545	\$ 570	—	—	—
84"W	T52484CS	ZR52484CS	\$ 708	\$ 744	\$ 777	—	—	—

30"D Primary Worksurface

Description	Laminate w/Flat Edge Model	Laminate w/Rabbit Edge Model	L1 List Price	L2 List Price	L3 List Price	L1 List Price	L2 List Price	L3 List Price
72"W	T53072CS	ZR53072CS	\$ 584	\$ 614	\$ 642	—	—	—
84"W	T53084CS	ZR53084CS	\$ 782	\$ 821	\$ 859	—	—	—

18"D / 24"D Linear Taper Worksurfaces

Description	Laminate w/Flat Edge Model	Laminate w/Rabbit Edge Model	L1 List Price	L2 List Price	L3 List Price	L1 List Price	L2 List Price	L3 List Price
48"W x 18"L x 24"R	Z5184824T	ZR5184824T	\$ 412	\$ 434	\$ 453	—	—	—
54"W x 18"L x 24"R	Z5185424T	ZR5185424T	\$ 455	\$ 479	\$ 500	—	—	—
60"W x 18"L x 24"R	Z5186024T	ZR5186024T	\$ 507	\$ 533	\$ 556	—	—	—
66"W x 18"L x 24"R	Z5186624T	ZR5186624T	\$ 547	\$ 575	\$ 601	—	—	—
72"W x 18"L x 24"R	Z5187224T	ZR5187224T	\$ 592	\$ 622	\$ 650	—	—	—
78"W x 18"L x 24"R	Z5187824T	ZR5187824T	\$ 711	\$ 747	\$ 780	—	—	—

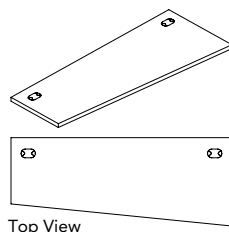

Top View

24"D / 18"D Linear Taper Worksurfaces

Description	Laminate w/Flat Edge Model	Laminate w/Rabbit Edge Model	L1 List Price	L2 List Price	L3 List Price	L1 List Price	L2 List Price	L3 List Price
48"W x 24"L x 18"R	Z5244818T	ZR5244818T	\$ 412	\$ 434	\$ 453	—	—	—
54"W x 24"L x 18"R	Z5245418T	ZR5245418T	\$ 455	\$ 479	\$ 500	—	—	—
60"W x 24"L x 18"R	Z5246018T	ZR5246018T	\$ 507	\$ 533	\$ 556	—	—	—
66"W x 24"L x 18"R	Z5246618T	ZR5246618T	\$ 547	\$ 575	\$ 601	—	—	—
72"W x 24"L x 18"R	Z5247218T	ZR5247218T	\$ 592	\$ 622	\$ 650	—	—	—
78"W x 24"L x 18"R	Z5247818T	ZR5247818T	\$ 711	\$ 747	\$ 780	—	—	—

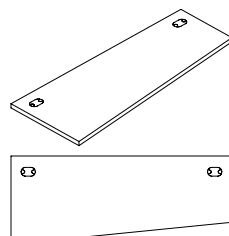

Top View

Notes: 1) Add Suffix "N" to a model number for no grommets, no upcharge. Examples: Z5184824TN, ZR5186024TN
2) Add Suffix "S" for scallop wire management detail for flat edge models only — no upcharge. Examples: Z5186024TS, ZR5186024TS

30"D / 36"D EZ View Transition Worksurfaces (non-handed)

Description	Laminate w/Flat Edge Model	Laminate w/Rabbit Edge Model	L1 List Price	L2 List Price	L3 List Price	L1 List Price	L2 List Price	L3 List Price
30"D x 60"W x 36"D	K5306036EZ	KR5306036EZ	\$ 903	\$ 947	\$ 992	—	—	—
30"D x 72"W x 36"D	K5307236EZ	KR5307236EZ	\$ 1057	\$ 1108	\$ 1160	—	—	—
30"D x 78"W x 36"D	K5307836EZ	KR5307836EZ	\$ 1268	\$ 1330	\$ 1394	—	—	—

Notes: 1) Add Suffix "N" to a model number for no grommets, no upcharge. Examples: K5306036EZN, KR5306036EZN

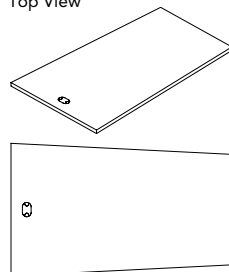

Top View

How to specify — Select the Model Number from above.	1st Option: Laminate Color: See inside front cover for finishes. (Upcharges are listed above.)	2nd Option: Edge Color: See inside front cover for finishes.	3rd Option: Grommet Location (if applicable): GC Center GCL Center and Left GCR Center and Right GCRL Center, Right, and Left	4th Option: Grommet Type: P Oval Plastic (Will match edge trim on laminate) M Oval Metal (Add \$11 per grommet) S Square Metal (Add \$11 per grommet)	5th Option: Grommet Color (Metal only): EL Matte Silver

Examples: T51848S.LM14.EW.P TR51848S.LWNW.EDNW.MEL

T51872CS.LM15EU.GCP K5306036EZ.LM13.EY.P

For specification information see pages 102-103.

For non-standard worksurface sizes see 9120 Program in any Systems price book.

Veneer

GSA SIN 711-1

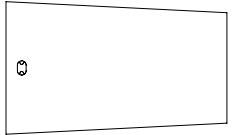
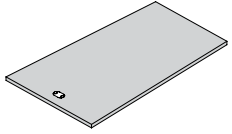
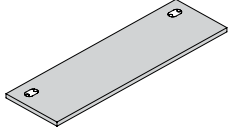
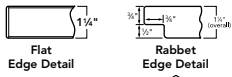

Top View

Description	Veneer w/Flat Edge Model	Veneer w/Rabbit Edge Model	Veneer w/Flat Edge			Veneer w/Rabbit Edge		
			V1 List Price	V3 List Price	V5 List Price	V1 List Price	V3 List Price	V5 List Price
18"D Primary Worksurfaces								
48"W	TV51848S	ZVR51848S	\$ 663	\$ 727	\$ 795	\$ —	\$ —	\$ —
54"W	TV51854S	ZVR51854S	\$ 721	\$ 791	\$ 862	\$ —	\$ —	\$ —
60"W	TV51860S	ZVR51860S	\$ 760	\$ 834	\$ 909	\$ —	\$ —	\$ —
72"W	TV51872S	ZVR51872S	\$ 855	\$ 939	\$ 1024	\$ —	\$ —	\$ —

Note: Add Suffix "N" to a model number for no grommets, no upcharge. *Examples:* TV51848SN, ZVR51848SN

30"D / 36"D EZ View Transition Worksurfaces (non-handed)

Description	KV5306036EZ	KVR5306036EZ	\$ 1884	\$ 2071	\$ 2259	\$ 2602	\$ 2861	\$ 3120
30"D x 60"W x 36"D								
30"D x 72"W x 36"D	KV5307236EZ	KVR5307236EZ	\$ 2140	\$ 2352	\$ 2566	\$ 2953	\$ 3247	\$ 3543
30"D x 78"W x 36"D	KV5307836EZ	KVR5307836EZ	\$ 2569	\$ 2825	\$ 3081	\$ 3547	\$ 3899	\$ 4255

Note: Add Suffix "N" to a model number for no grommets, no upcharge. *Examples:* KV5306036EZN, KVR5306036EZN

<p>How to specify —</p> <p>Select the Model Number from above.</p> <p>Prefix TV5, ZV5 or KV5 for Flat Edge ZVR5 or KVR5 for Rabbit Edge</p>	<p>1st Option:</p> <p>Veneer: See inside front cover for finishes.</p>	<p>2nd Option:</p> <p>Grommet Location (if applicable): GC Center GCL Center and Left GCR Center and Right GCRL Center, Right, and Left</p>	<p>3rd Option:</p> <p>Grommet Type: P Oval Plastic (Color is predetermined based on finish selection.) M Oval Metal S Square Metal</p>	<p>4th Option:</p> <p>Grommet Color (Metal only): Oval: E4 Black EZ Bronze EL Matte Silver Square: EL Matte Silver</p>
---	--	---	--	---

Examples: TV51848S.NC777.SEL ZVR51848S.NC777 KV5306036EZ.NC777.P

For specification information see pages 102-103.

GSA SIN 711-1

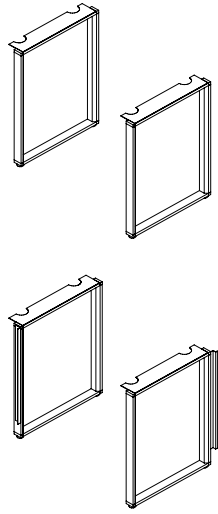

Description	Model	Core Paint		Select Paint	
		P1 List Price	P2 List Price	P1 List Price	P2 List Price
29½"H Open End Panel Supports — Painted Metal					
18"D Freestanding for Flat/Square Edge	K62918FENA	\$ 482		\$ 505	
24"D Freestanding for Flat/Square Edge (shown)	K62924FENA	\$ 522		\$ 545	
30"D Freestanding for Flat/Square Edge	K62930FENA	\$ 566		\$ 589	
18"D Freestanding for Rabbet Edge	K6R2918FENA	\$ 475		\$ 498	
24"D Freestanding for Rabbet Edge (shown)	K6R2924FENA	\$ 519		\$ 542	
30"D Freestanding for Rabbet Edge	K6R2930FENA	\$ 561		\$ 584	
29½"H Closed End Panel Supports — Laminate with Metal Brackets					
18"D Freestanding for Flat/Square Edge	K62918FEN	\$ 608	\$ 639	\$ 667	
24"D Freestanding for Flat/Square Edge (shown)	K62924FEN	\$ 634	\$ 666	\$ 695	
30"D Freestanding for Flat/Square Edge	K62930FEN	\$ 660	\$ 693	\$ 723	
18"D Panel-Mount for Flat/Square Edge — Left	K62918LPEN	\$ 659	\$ 692	\$ 722	
18"D Panel-Mount for Flat/Square Edge — Right	K62918RPEN	\$ 659	\$ 692	\$ 722	
24"D Panel-Mount for Flat/Square Edge (shown) — Left	K62924LPEN	\$ 683	\$ 717	\$ 748	
24"D Panel-Mount for Flat/Square Edge (shown) — Right	K62924RPEN	\$ 683	\$ 717	\$ 748	
30"D Panel-Mount for Flat/Square Edge — Left	K62930LPEN	\$ 703	\$ 738	\$ 772	
30"D Panel-Mount for Flat/Square Edge — Right	K62930RPEN	\$ 703	\$ 738	\$ 772	

NOTE: No upcharge for PR6 Silver paint on Involve.

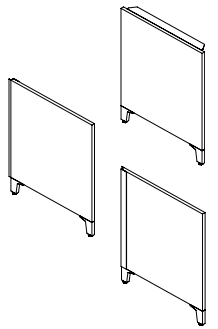

Description	Model	L1	L2	L3
		Laminate List Price	Laminate List Price	Laminate List Price
Storage-to-Panel Bracket Kits for 24"H and 28"H Credenzas only — Painted Metal				
24"H Left (requires laminate back) (shown)	K624PBKL	\$ 105		\$ 119
24"H Right (requires laminate back)	K624PBKR	\$ 105		\$ 119
28"H Left (requires laminate back)	K630PBKL	\$ 116		\$ 130
28"H Right (requires laminate back)	K630PBKR	\$ 116		\$ 130
24"H Left (does not require laminate back)	K624PBKML	\$ 105		\$ 119
24"H Right (does not require laminate back)	K624PBKMR	\$ 105		\$ 119
28"H Left (does not require laminate back)	K630PBKML	\$ 116		\$ 130
28"H Right (does not require laminate back)	K630PBKMR	\$ 116		\$ 130



Description	Model	Core Paint		Select Paint	
		P1 List Price	P2 List Price	P1 List Price	P2 List Price
Storage-to-Panel Bracket Kits for 24"H and 28"H Credenzas only — Painted Metal					
24"H Left (requires laminate back) (shown)	K624PBKL	\$ 105		\$ 119	
24"H Right (requires laminate back)	K624PBKR	\$ 105		\$ 119	
28"H Left (requires laminate back)	K630PBKL	\$ 116		\$ 130	
28"H Right (requires laminate back)	K630PBKR	\$ 116		\$ 130	
24"H Left (does not require laminate back)	K624PBKML	\$ 105		\$ 119	
24"H Right (does not require laminate back)	K624PBKMR	\$ 105		\$ 119	
28"H Left (does not require laminate back)	K630PBKML	\$ 116		\$ 130	
28"H Right (does not require laminate back)	K630PBKMR	\$ 116		\$ 130	

<p>How to specify — Select the Model Number from above.</p>	<p>1st Option: FSC Certified Wood (if applicable): FSC Select for FSC Certified Wood X No FSC</p>	<p>2nd Option: Laminate (if applicable): See inside front cover for finishes.</p>	<p>3rd Option: Edge Color (if applicable): See inside front cover for finishes.</p>	<p>4th Option: Paint: Ⓞ Ⓢ See inside front cover for finishes. For Select P2 Paints (except PR6) on Closed End Panel Supports add \$26.</p>
--	--	--	--	---

Examples: K62918FENA.P7B K624PBKR.P7B K62918LPEN.X.LM11EV.P7B

For specification information see pages 102-103.

GSA SIN 711-1

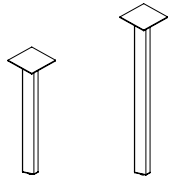

Description	Model	Core Paint	Select Paint
		P1 List Price	P2 List Price
Post Leg — Painted Metal			
29½"H	K629SCF	\$ 263	\$ 286
40½"H	K640SCF	\$ 315	\$ 338

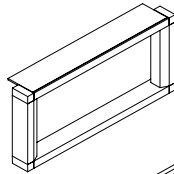

Worksurface Stanchion — Painted Metal			
12"D x 5¼"H for Involve 24"H Credenza	K6SS0512	\$ 342	\$ 365
18"D x 5¼"H for Involve 24"H Credenza	K6SS0518	\$ 354	\$ 377
12"D x 4"H for Stride 22"H Credenza	Z6SS0412	\$ 327	\$ 350
18"D x 4"H for Stride 22"H Credenza	Z6SS0418	\$ 339	\$ 362

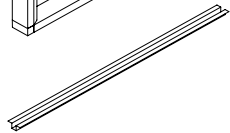

External Worksurface Support Channel (Black Only)			
30"W for use on 42"W Worksurface	Z5SC42	\$ 50	N/A
36"W for use on 48"W Worksurface	Z5SC48	\$ 52	N/A
42"W for use on 54"W Worksurface	Z5SC54	\$ 59	N/A
48"W for use on 60"W Worksurface	Z5SC60	\$ 64	N/A
54"W for use on 66"W Worksurface	Z5SC66	\$ 73	N/A
60"W for use on 72"W Worksurface	Z5SC72	\$ 79	N/A
66"W for use on 78"W Worksurface	Z5SC78	\$ 86	N/A

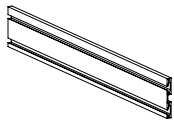

Tower Rail (supports worksurface on side of tower — requires rail bracket kit)			
18"W Tower Rail for 18"D Tower	K6TR18	\$ 113	\$ 120
24"W Tower Rail for 24"D Tower	Z6TR24	\$ 126	\$ 141
Rail Bracket Kit for Worksurface (PR6 Silver only)	Z6RBK	\$ 60	N/A

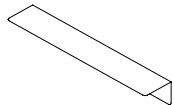

"L" Tower Bracket — for Wood Towers			
"L" Tower Bracket for 18"D or 24"D Tower	Z6LB	\$ 48	\$ 62

How to specify —
Select the Model Number from above.

1st Option:
Paint
(if applicable):
C S
 See inside front cover for finishes.

No upcharge for PR6 Silver paint on Involve.

Examples: K629SCF.P7B K6SS0512.P7B Z5SC60

S Shippable by small-package carrier.

For specification information see page 105.

GSA SIN 711-1

ALIGN METAL SPEC

ALIGN PRICING

ESSENTIALS SPEC

ESSENTIALS PRICING

VERTICALS

INVOLVE SPEC

INVOLVE PRICING

ALIGN VENEER

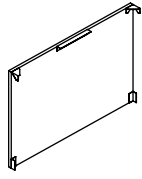

	Laminate w/Flat Edge Laminate	L1 List Price	Laminate L2 List Price	L3 List Price
Full-Height Laminate Modesty Panels for use with Footed Storage				
29"W	K6DM2829L	\$ 594	\$ 624	\$ 653
30"W	K6DM2830L	\$ 594	\$ 624	\$ 653
34"W	K6DM2834L	\$ 622	\$ 654	\$ 683
35"W	K6DM2835L	\$ 622	\$ 654	\$ 683
36"W	K6DM2836L	\$ 622	\$ 654	\$ 683
40"W	K6DM2840L	\$ 650	\$ 683	\$ 714
41"W	K6DM2841L	\$ 650	\$ 683	\$ 714
42"W	K6DM2842L	\$ 650	\$ 683	\$ 714
43"W	K6DM2843L	\$ 650	\$ 683	\$ 714
46"W	K6DM2846L	\$ 679	\$ 713	\$ 745
47"W	K6DM2847L	\$ 679	\$ 713	\$ 745
49"W	K6DM2849L	\$ 679	\$ 713	\$ 745
53"W	K6DM2853L	\$ 713	\$ 748	\$ 783
55"W	K6DM2855L	\$ 710	\$ 745	\$ 780
58"W	K6DM2858L	\$ 741	\$ 778	\$ 814
59"W	K6DM2859L	\$ 741	\$ 778	\$ 814
61"W	K6DM2861L	\$ 741	N/A	N/A
64"W	K6DM2864L	\$ 775	N/A	N/A
70"W	K6DM2870L	\$ 809	N/A	N/A
76"W	K6DM2876L	\$ 840	N/A	N/A

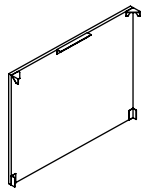

Full-Height Laminate Modesty Panels for use with Plinth Base Storage				
30"W	K6DMP2830L	\$ 594	\$ 624	\$ 653
34"W	K6DMP2834L	\$ 622	\$ 654	\$ 683
36"W	K6DMP2836L	\$ 622	\$ 654	\$ 683
40"W	K6DMP2840L	\$ 650	\$ 683	\$ 714
42"W	K6DMP2842L	\$ 650	\$ 683	\$ 714
46"W	K6DMP2846L	\$ 679	\$ 713	\$ 745

Modesty Width Chart APPLICATION	DESKING WORKSURFACE WIDTH			
	60"W	66"W	72"W	78"W
2 - 24"W Peds				30"W
1 - 24"W + 1 - 18"W Ped			30"W	36"W
2 - 18"W Peds		30"W	36"W	42"W
2 - 15"W Peds		34"W	40"W	46"W
1 - 15"W Ped + Closed End Gable	43"W	49"W	55"W	61"W
1 - 18"W Ped + Closed End Gable	41"W	47"W	53"W	59"W
1 - 24"W Ped + Closed End Gable	35"W	41"W	47"W	53"W
1 - 30"W Lat + Closed End Gable	29"W	35"W	41"W	47"W
1 - 36"W Lat + Closed End Gable		29"W	35"W	41"W
2 Closed Gable Ends	58"W	64"W	70"W	76"W

Example: When using a 66"W worksurface and 2 - 18"W pedestals, specify a 30"W modesty.

<p>How to specify — Select the Model Number from above.</p>	<p><i>1st Option:</i> FSC Certified Wood (if applicable): FSC Select for FSC Certified Wood X No FSC</p>	<p><i>2nd Option:</i> Laminate Color: See inside front cover for finishes.</p>	<p><i>3rd Option:</i> Matching Edge: See inside front cover for finishes.</p>	<p><i>4th Option:</i> Paint Color: G S See inside front cover for finishes. For Select P2 Paints add \$7 (except PR6).</p>
<p>K . . </p>				<p>P </p>

Examples: K6DM2829L.X.LM13EY.P7D
K6DMP2830L.FSC.LM11EV.P7B

[S] Shippable by small-package carrier.

For specification information see page 105.

GSA SIN 711-1

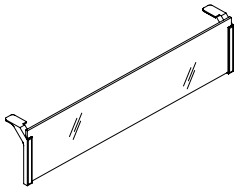

Description	Model	Frosted List Price
11"H Glass End (single) Mounting — 3/8" Thick		
36"W	K6DME1136G	\$ 721
42"W	K6DME1142G	\$ 742
48"W	K6DME1148G	\$ 765
54"W	K6DME1154G	\$ 795
60"W	K6DME1160G	\$ 812

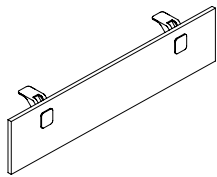

Description	Model	L1	L2	L3
		Laminate List Price	Laminate List Price	Laminate List Price
11"H Laminate End (single) Mounting — 3/4" Thick				
36"W	K6DME1136L	\$ 427	\$ 450	\$ 468
42"W	K6DME1142L	\$ 467	\$ 491	\$ 513
48"W	K6DME1148L	\$ 505	\$ 532	\$ 554
54"W	K6DME1154L	\$ 545	\$ 574	\$ 599
60"W	K6DME1160L	\$ 587	\$ 617	\$ 645

<p>How to specify — Select the Model Number from above.</p>	<p><i>1st Option:</i> Glass (if applicable): LF Frosted</p>	<p><i>1st Option:</i> Laminate (if applicable): See inside front cover for finishes.</p>	<p><i>2nd Option:</i> Edge (if applicable): See inside front cover for finishes.</p>	<p><i>3rd Option:</i> Paint: CS See inside front cover for finishes. For Select P2 Paints add \$7 (except PR6).</p>
<p>_____ . LF .</p>				

Examples: K6DME1136G.LF.P7B K6DME1136L.LM11EV.P7B

For specification information see page 105.

GSA SIN 711-1

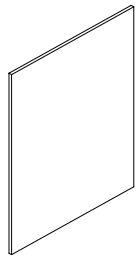
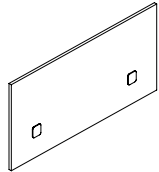
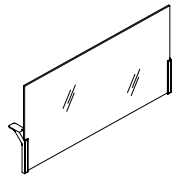

Description	Model	Frosted List Price	Marker Board List Price
25"H Glass End Privacy Panel — (single) Mounting 3/8" Thick			
36"W	K6DFE2536G	\$ 824	\$ 1190
42"W	K6DFE2542G	\$ 902	\$ 1330
48"W	K6DFE2548G	\$ 979	\$ 1520
54"W	K6DFE2554G	\$ 1067	\$ 1617
60"W	K6DFE2560G	\$ 1153	\$ 1756

Description	Model	L1 Laminate List Price	L2 Laminate List Price	L3 Laminate List Price
25"H Laminate End Privacy Panel — (single) Mounting 3/8" Thick				
36"W	K6DFE2536L	\$ 521	\$ 549	\$ 572
42"W	K6DFE2542L	\$ 563	\$ 592	\$ 619
48"W	K6DFE2548L	\$ 604	\$ 635	\$ 663
54"W	K6DFE2554L	\$ 642	\$ 675	\$ 705
60"W	K6DFE2560L	\$ 682	\$ 716	\$ 748

50"H Laminate Divider Panel — 3/4" Thick				
29"W	K6DP5029L	\$ 659	\$ 692	\$ 723
35"W	K6DP5035L	\$ 718	\$ 754	\$ 789
47"W	K6DP5047L	\$ 782	\$ 820	\$ 859
59"W	K6DP5059L	\$ 839	\$ 880	\$ 923

<p>How to specify — Select the Privacy Panel Model Number from above.</p>	<p><i>1st Option:</i> Glass (if applicable): LF Frosted LM Writable Marker Board Glass</p>	<p><i>1st Option:</i> Laminate (if applicable): See inside front cover for finishes.</p>	<p><i>2nd Option:</i> Edge (if applicable): See inside front cover for finishes.</p>	<p><i>3rd Option:</i> Paint: C S See inside front cover for finishes. For Select P2 Paints add \$7 (except PR6).</p>
	<p>_____ . L _____ .</p>	<p>_____ . _____ .</p>	<p>_____ . _____ .</p>	<p>_____ . _____ .</p>

<p>How to specify — Select the Divider Panel Model Number from above.</p>	<p><i>1st Option:</i> FSC Certified Wood: FSC Select for FSC Certified Wood X No FSC</p>	<p><i>2nd Option:</i> Laminate Color: See inside front cover for finishes.</p>	<p><i>3rd Option:</i> Matching Edge: See inside front cover for finishes.</p>
	<p>_____ . _____ .</p>	<p>_____ . _____ .</p>	<p>_____ . _____ .</p>

Examples: K6DFE2536G.LF.P7B K6DFE2536L.LM11EV.P7B K6DP5029L.X.LM11EV

For specification information see page 105.

GSA SIN 711-1

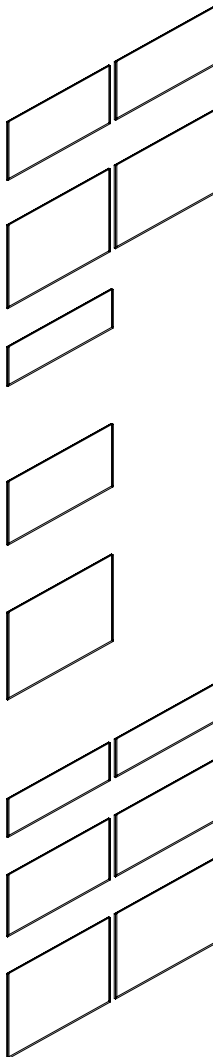
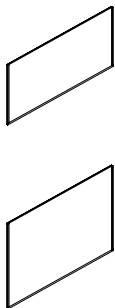

Description	Model	List Price					
		Grade A	Grade B	Grade C	Grade D	Grade E	Grade F
Tackable Taskpanel for use with Stanchion Mounted Overhead on 24"H Credenza — ½"D							
30"W x 18"H	K6TB1830T	\$ 329	\$ 363	\$ 393	\$ 423	\$ 453	\$ 483
36"W x 18"H	K6TB1836T	\$ 360	\$ 396	\$ 431	\$ 466	\$ 501	\$ 536
42"W x 18"H	K6TB1842T	\$ 390	\$ 429	\$ 467	\$ 505	\$ 543	\$ 581
48"W x 18"H	K6TB1848T	\$ 420	\$ 461	\$ 504	\$ 547	\$ 590	\$ 633
60"W x 18"H	K6TB1860T	\$ 479	\$ 526	\$ 573	\$ 620	\$ 667	\$ 714
30"W x 26"H	K6TB2630T	\$ 378	\$ 416	\$ 453	\$ 490	\$ 527	\$ 564
36"W x 26"H	K6TB2636T	\$ 407	\$ 447	\$ 487	\$ 527	\$ 567	\$ 607
42"W x 26"H	K6TB2642T	\$ 438	\$ 482	\$ 525	\$ 568	\$ 611	\$ 654
48"W x 26"H	K6TB2648T	\$ 467	\$ 513	\$ 559	\$ 605	\$ 651	\$ 697
60"W x 26"H	K6TB2660T	\$ 527	\$ 579	\$ 631	\$ 683	\$ 735	\$ 787

Description	Stanchions at Both Ends Model	1 Stanchion 1 Tower Model	Towers at Both Ends Model	List Price					
				Grade A	Grade B	Grade C	Grade D	Grade E	Grade F
Tackable Taskpanel for use with overhead 72"W or greater on 24"H credenzas — ½"D									
72"W x 18"H	K6TB1872T	K6TB18721T	K6TB18722T	\$ 528	\$ 580	\$ 632	\$ 684	\$ 736	\$ 788
84"W x 18"H	K6TB1884T	K6TB18841T	K6TB18842T	\$ 580	\$ 638	\$ 694	\$ 750	\$ 806	\$ 862
96"W x 18"H	K6TB1896T	K6TB18961T	K6TB18962T	\$ 639	\$ 702	\$ 764	\$ 826	\$ 888	\$ 950
72"W x 26"H	K6TB2672T	K6TB26721T	K6TB26722T	\$ 602	\$ 662	\$ 721	\$ 780	\$ 839	\$ 898
84"W x 26"H	K6TB2684T	K6TB26841T	K6TB26842T	\$ 662	\$ 727	\$ 792	\$ 857	\$ 922	\$ 987
96"W x 26"H	K6TB2696T	K6TB26961T	K6TB26962T	\$ 728	\$ 799	\$ 873	\$ 947	\$ 1021	\$ 1095

Description	Model	List Price					
		Grade A	Grade B	Grade C	Grade D	Grade E	Grade F
Tackable Taskpanel for use with stanchion mounted overhead on 28"H credenza — ½"D							
30"W x 12"H	K6TB1230T	\$ 306	\$ 338	\$ 370	\$ 402	\$ 434	\$ 466
36"W x 12"H	K6TB1236T	\$ 335	\$ 369	\$ 400	\$ 431	\$ 462	\$ 493
42"W x 12"H	K6TB1242T	\$ 367	\$ 404	\$ 440	\$ 476	\$ 512	\$ 548
48"W x 12"H	K6TB1248T	\$ 396	\$ 435	\$ 474	\$ 513	\$ 552	\$ 591
60"W x 12"H	K6TB1260T	\$ 456	\$ 501	\$ 546	\$ 591	\$ 636	\$ 681
30"W x 19"H	K6TB1930T	\$ 329	\$ 363	\$ 393	\$ 423	\$ 453	\$ 483
36"W x 19"H	K6TB1936T	\$ 360	\$ 396	\$ 431	\$ 466	\$ 501	\$ 536
42"W x 19"H	K6TB1942T	\$ 390	\$ 429	\$ 467	\$ 505	\$ 543	\$ 581
48"W x 19"H	K6TB1948T	\$ 420	\$ 461	\$ 504	\$ 547	\$ 590	\$ 633
60"W x 19"H	K6TB1960T	\$ 479	\$ 526	\$ 573	\$ 622	\$ 708	\$ 790
30"W x 27"H	K6TB2730T	\$ 378	\$ 416	\$ 453	\$ 490	\$ 527	\$ 564
36"W x 27"H	K6TB2736T	\$ 407	\$ 447	\$ 487	\$ 527	\$ 567	\$ 607
42"W x 27"H	K6TB2742T	\$ 438	\$ 482	\$ 525	\$ 568	\$ 611	\$ 654
48"W x 27"H	K6TB2748T	\$ 467	\$ 513	\$ 559	\$ 605	\$ 651	\$ 697
60"W x 27"H	K6TB2760T	\$ 527	\$ 579	\$ 631	\$ 683	\$ 735	\$ 787

Description	Stanchions at Both Ends Model	1 Stanchion 1 Tower Model	Towers at Both Ends Model	List Price					
				Grade A	Grade B	Grade C	Grade D	Grade E	Grade F
Tackable Taskpanel for use with overhead 72"W or greater on 28"H credenzas — ½"D									
72"W x 12"H	K6TB1272T	K6TB12721T	K6TB12722T	\$ 499	\$ 548	\$ 596	\$ 644	\$ 692	\$ 740
84"W x 12"H	K6TB1284T	K6TB12841T	K6TB12842T	\$ 547	\$ 601	\$ 655	\$ 709	\$ 763	\$ 817
96"W x 12"H	K6TB1296T	K6TB12961T	K6TB12962T	\$ 603	\$ 663	\$ 722	\$ 781	\$ 840	\$ 899
72"W x 19"H	K6TB1972T	K6TB19721T	K6TB19722T	\$ 528	\$ 580	\$ 632	\$ 684	\$ 736	\$ 788
84"W x 19"H	K6TB1984T	K6TB19841T	K6TB19842T	\$ 580	\$ 638	\$ 694	\$ 753	\$ 811	\$ 869
96"W x 19"H	K6TB1996T	K6TB19961T	K6TB19962T	\$ 639	\$ 702	\$ 764	\$ 826	\$ 888	\$ 950
72"W x 27"H	K6TB2772T	K6TB27721T	K6TB27722T	\$ 602	\$ 662	\$ 721	\$ 780	\$ 839	\$ 898
84"W x 27"H	K6TB2784T	K6TB27841T	K6TB27842T	\$ 662	\$ 727	\$ 792	\$ 857	\$ 922	\$ 987
96"W x 27"H	K6TB2796T	K6TB27961T	K6TB27962T	\$ 728	\$ 799	\$ 873	\$ 947	\$ 1021	\$ 1095

<p>How to specify — Select the Model Number from above.</p>	<p>1st Option: Paint: C S See inside front cover for finishes. For Select P2 Paints add \$26 (except PR6).</p>	<p>2nd Option: Panel Fabric: See inside back cover for fabrics.</p>
--	--	--

K | 6 | T | B | | | | | | | | | | | | | | | . | | | | | | | | | | | | . | | | | | | | | | | | | | | | | | | | |

Example: K6TB1830T.P7B.APN911

[S] Shippable by small-package carrier.

ALIGN METAL SPEC
ALIGN PRICING
ESSENTIALS SPEC
ESSENTIALS PRICING
VERTICALS
INVOLVE SPEC
INVOLVE PRICING
ALIGN VENEER

Involve® Laminate Powered Storage

24"H Powered Credenzas

For specification information see pages 106-115.

GSA SIN 711-2

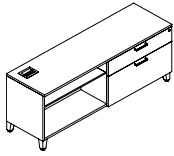

Description	Solid Color "KL" or "K2T" for Woodgrain or Two-Tone Model	Lock Qty	Solid Laminate List Price	UPCHARGES*			
				L2 Laminate Case Front		L3 Laminate Case Front	
24"H Powered** Credenza — Box/Lateral and Open Side with Metal Shelf #							
48"W x 18"D Lat/RH Open	K □ E244818RAF	1	\$ 3103	\$ 108	\$ 47	\$ 217	\$ 92
48"W x 18"D LH Open/Lat	K □ E244818LAF	1	\$ 3103	\$ 108	\$ 47	\$ 217	\$ 92
48"W x 24"D Lat/RH Open	K □ E244824RAF	1	\$ 3228	\$ 112	\$ 48	\$ 224	\$ 95
48"W x 24"D LH Open/Lat	K □ E244824LAF	1	\$ 3228	\$ 112	\$ 48	\$ 224	\$ 95
60"W x 18"D Lat/RH Open	K □ E246018RAF	1	\$ 3246	\$ 112	\$ 48	\$ 226	\$ 96
60"W x 18"D LH Open/Lat (shown)	K □ E246018LAF	1	\$ 3246	\$ 112	\$ 48	\$ 226	\$ 96
60"W x 24"D Lat/RH Open	K □ E246024RAF	1	\$ 3375	\$ 116	\$ 50	\$ 235	\$ 99
60"W x 24"D LH Open/Lat	K □ E246024LAF	1	\$ 3375	\$ 116	\$ 50	\$ 235	\$ 99
72"W x 18"D Lat/RH Open	K □ E247218RAF	1	\$ 3519	N/A	\$ 52	N/A	\$ 102
72"W x 18"D LH Open/Lat	K □ E247218LAF	1	\$ 3519	N/A	\$ 52	N/A	\$ 102
72"W x 24"D Lat/RH Open	K □ E247224RAF	1	\$ 3666	N/A	\$ 54	N/A	\$ 109
72"W x 24"D LH Open/Lat	K □ E247224LAF	1	\$ 3666	N/A	\$ 54	N/A	\$ 109

Note: If used in freestanding application, a laminate back is required for stability.



Laminate Back for 24"H Powered Credenzas			L2 Laminate	L3 Laminate
18"W	KLECB2418	\$ 268	\$ 14	\$ 28
24"W	KLECB2424	\$ 274	\$ 14	\$ 29
30"W (shown)	KLECB2430	\$ 280	\$ 15	\$ 29
36"W	KLECB2436	\$ 285	\$ 15	\$ 30
48"W	KLECB2448	\$ 299	\$ 15	\$ 31
60"W	KLECB2460	\$ 342	\$ 19	\$ 34
72"W	KLECB2472	\$ 378	N/A	N/A

*Upcharges are added to solid laminate list price depending on woodgrain laminate selection.

**Units are power ready and require electrical harnesses, in-feed, and receptacles — order separately.

#Unit may require counterweight kits, see page 99.

<p>How to specify —</p> <p>Select the Model Number from above.</p> <p>KL prefix for case/front with same Solid Color Laminate</p> <p>K2T prefix for any Woodgrain or Two-Tone Laminate</p>	<p><i>1st Option:</i></p> <p>Foot Type (if applicable):</p> <p>TF Terrace Foot</p> <p>ZF Stride Foot (Add \$77)</p>	<p><i>2nd Option:</i></p> <p>Foot Paint Color (if applicable):</p> <p>C S</p> <p>See inside front cover for finishes. Stride is limited to PR6 Silver.</p>	<p><i>3rd Option:</i></p> <p>Pull Type (if applicable):</p> <p>AP Arch</p> <p>SP Square Pull</p> <p>HP Straight Pull</p>	<p><i>4th Option:</i></p> <p>Pull Color (if applicable):</p> <p>PR6 Silver</p>	<p><i>5th Option:</i></p> <p>Metal Shelf (if applicable):</p> <p>C S A</p> <p>Add \$27 for Select P2 (except PR6) or \$49 for Accent P3 Paints on shelf.</p>
K .		P .		P R 6 .	

Continued below ▼

<p><i>6th Option:</i></p> <p>FSC Certified Wood:</p> <p>FSC Select for FSC Certified Wood</p> <p>X No FSC</p>	<p><i>7th Option:</i></p> <p>Laminate** Color:</p> <p>See inside front cover for finishes.</p> <p>(If two-tone list case color here.)</p>	<p><i>8th Option:</i></p> <p>Matching Edge:</p> <p>See inside front cover for finishes.</p>	<p><i>9th Option:</i></p> <p>2nd Laminate Color (Front) (if applicable):</p> <p>See inside front cover for finishes.</p>	<p><i>10th Option:</i></p> <p>Matching Edge (if applicable):</p> <p>See inside front cover for finishes.</p>	<p><i>11th Option:</i></p> <p>Lock (if applicable):</p> <p>STD Standard</p> <p>OMT Omit Lock Core (deduct \$18 per lock)</p>	<p><i>12th Option:</i></p> <p>Lock Color (if applicable):</p> <p>EL Silver</p>
.						E L

Examples: K2TE244818RAF.TFPO8.APPR6.PR6.X.LM16E9.LM16E9.STDEL
KLECB2430.FSC.LM11EV

Involve® Laminate Powered Storage

28"H Powered Credenzas

For specification information see pages 106-115.

GSA SIN 711-2

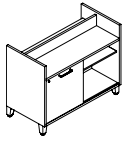

Description	Solid Color "KL" or "K2T" for Woodgrain or Two-Tone Model	Lock Qty	Solid Laminate List Price	UPCHARGES*			
				L2 Laminate Front Case		L3 Laminate Front Case	
28"H Powered** Support Credenza — Sliding Door (Locking) with Metal Shelf (without top; non-handed)							
36"W x 18"D (shown)	K □ E283618N	1	\$ 2484	\$ 86	\$ 37	\$ 173	\$ 73
36"W x 24"D	K □ E283624N	1	\$ 2583	\$ 90	\$ 38	\$ 180	\$ 76
48"W x 18"D	K □ E284818N	1	\$ 2775	\$ 95	\$ 41	\$ 192	\$ 82
48"W x 24"D	K □ E284824N	1	\$ 2904	\$ 99	\$ 43	\$ 201	\$ 86

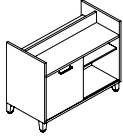

28"H Powered** Support Credenza — Sliding Door (Non-locking) with Metal Shelf (without top; non-handed)							
36"W x 18"D (shown)	K □ E283618NUL	0	\$ 2484	\$ 86	\$ 37	\$ 173	\$ 86
36"W x 24"D	K □ E283624NUL	0	\$ 2583	\$ 90	\$ 38	\$ 180	\$ 76
48"W x 18"D	K □ E284818NUL	0	\$ 2775	\$ 95	\$ 41	\$ 192	\$ 82
48"W x 24"D	K □ E284824NUL	0	\$ 2904	\$ 99	\$ 43	\$ 201	\$ 86

**Non-locking and open models are pending UL code.



Description	Solid Color "KL" or "K2T" for Woodgrain or Two-Tone Model	List Price	L2 Laminate	L3 Laminate
			Case	Case
28"H Powered** Support Credenza — Open Cubby w/Metal Shelf (without top)				
18"W x 18"D	K □ E281818A	\$ 1423	\$ 49	\$ 98
18"W x 24"D	K □ E281824A	\$ 1482	\$ 51	\$ 101
24"W x 18"D	K □ E282418A	\$ 1534	\$ 52	\$ 107
24"W x 24"D	K □ E282424A	\$ 1596	\$ 54	\$ 111
30"W x 18"D (shown)	K □ E283018A	\$ 1609	\$ 56	\$ 111
30"W x 24"D	K □ E283024A	\$ 1670	\$ 57	\$ 115
36"W x 18"D	K □ E283618A	\$ 1681	\$ 58	\$ 115
36"W x 24"D	K □ E283624A	\$ 1746	\$ 60	\$ 120

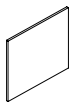

Description	Solid Color "KL" or "K2T" for Woodgrain or Two-Tone Model	List Price	L2 Laminate	L3 Laminate
			Case	Case
Laminate Back for 28"H Powered** Credenzas				
18"W	KLECB2818	\$ 297	\$ 15	\$ 29
24"W	KLECB2824	\$ 285	\$ 15	\$ 30
30"W (shown)	KLECB2830	\$ 304	\$ 18	\$ 31
36"W	KLECB2836	\$ 316	\$ 18	\$ 32
48"W	KLECB2848	\$ 342	\$ 19	\$ 34

*Upcharges are added to solid laminate list price depending on woodgrain laminate selection.

**Units are power ready and require electrical harnesses, in-feed, and receptacles — order separately.

<p>How to specify — Select the Model Number from above.</p> <p>KL prefix for case/front with same Solid Color Laminate K2T prefix for any Woodgrain or Two-Tone Laminate</p>	<p>1st Option: Foot Type (if applicable): TF Terrace Foot ZF Stride Foot (Add \$77)</p>	<p>2nd Option: Foot Paint Color (if applicable): C S See inside front cover for finishes. Stride is limited to PR6 Silver.</p>	<p>3rd Option: Pull Type (if applicable): AP Arch SP Square Pull HP Straight Pull</p>	<p>4th Option: Pull Color (if applicable): PR6 Silver</p>	<p>5th Option: Metal Shelf (if applicable): C S A Add \$27 for Select P2 (except PR6) or \$49 for Accent P3 Paints on shelf.</p>
K .		P .		P R 6 .	.

Continued below ▼

<p>6th Option: FSC Certified Wood: FSC Select for FSC Certified Wood X No FSC</p>	<p>7th Option: Laminate** Color: See inside front cover for finishes. (If two-tone list case color here.)</p>	<p>8th Option: Matching Edge: See inside front cover for finishes.</p>	<p>9th Option: 2nd Laminate Color (Front) (if applicable): See inside front cover for finishes.</p>	<p>10th Option: Matching Edge (if applicable): See inside front cover for finishes.</p>	<p>11th Option: Lock (if applicable): STD Standard OMT Omit Lock Core (deduct \$18 per lock)</p>	<p>12th Option: Lock Color (if applicable): EL Silver</p>
.		.		.		E L

Examples: K2TE283618N.TFPO8.APPR6.PR6.X.LM16E9.LM16E9.STDEL

KLE283618NUL.ZFPR6.SPPR6.P7B.FSC.LM11EV KLECB2830.FSC.LM11EV

Involve® Laminate Powered Storage

Tops for Powered Credenzas

For specification information see pages 106-115.

GSA SIN 711-2

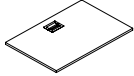
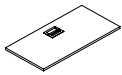

Order Grommet Separately

Description	Model	L1 Laminate List Price	UPCHARGES*	
			L2 Laminate	L3 Laminate
Laminate Tops — 18"D Grommet Cutout Centered (same thickness as worksurfaces)				
36"W	K5ECT1836L	\$ 276	\$ 14	\$ 29
48"W	K5ECT1848L	\$ 288	\$ 15	\$ 30
Laminate Tops — 24"D Grommet Cutout Centered (same thickness as worksurfaces)				
36"W	K5ECT2436L	\$ 303	\$ 15	\$ 31
48"W	K5ECT2448L	\$ 317	\$ 18	\$ 32

Note: Rectangular grommet for above worksurfaces needs to be ordered separately.

*Upcharges are added to solid laminate list price depending on woodgrain laminate selection.

<p>How to specify — Select the Model Number from above.</p>	<p>1st Option: Laminate Color: See inside front cover for finishes. (Woodgrain upcharges are listed above.)</p>	<p>2nd Option: Matching Edge Color: See inside front cover for finishes.</p>
<p>K 5 E C T L . </p>		

Examples: K5ECT1836L.LM14EW

Involve[®] Laminate Powered Storage

Electrical & Data

For specification information see pages 106-115.

GSA SIN 711-1

Description	Max. Recept.		Four-circuit 3 + 1 2 + 2	Three-circuit Separate Neutrals	List Price
	Capacity Per Side	Side			

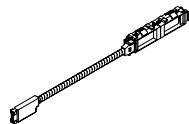

Extended Electrical Power Harnesses with Power Blocks for Involve					
For 66"W Run	2		A87123066	A87123066A	\$ 238
For 72"W Run	2		A87123072	A87123072A	\$ 248
For 84"W Run	2		A87123084	A87123084A	\$ 263
For 96"W Run	2		A87123096	A87123096A	\$ 281
For 120"W Run	2		A871230120	A871230120A	\$ 314
For 144"W Run	2		A871230144	A871230144A	\$ 347

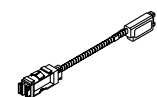

Electrical Pass-Thru Harnesses with Power Block					
For 24"W**	1		A871124	A871124A	\$ 137
For 30"W**	1		A871130	A871130A	\$ 137
For 36"W**	1		A871136*	A871136A	\$ 137
For 42"W**	1		A871142*	A871142A	\$ 144
For 48"W**	1		A871148*	A871148A	\$ 144
For 60"W**	1		A871160*	A871160A	\$ 144
For 72"W**	1		A871172	A871172A	\$ 193
For 96"W**	1		A871196	A871196A	\$ 226
For 120"W**	1		A8711120	A8711120A	\$ 262
For 144"W**	1		A8711144	A8711144A	\$ 299

* Electrical harnesses are intended for use with Allsteel systems furniture and are approved under GSA SIN 711-1. When purchased separately and used without Allsteel systems furniture, those electrical harnesses marked by (*) are considered Open Market.



Electrical Pass-Thru Cable without Power Block					
For 18"W	0		A871018	A871018A	\$ 124
For 60"W**	0		A871060	A871060A	\$ 130
For 66"W	0		A871066	A871066A	\$ 169
For 72"W**	0		A871072	A871072A	\$ 180
For 78"W	0		A871078	A871078A	\$ 185
For 84"W	0		A871084	A871084A	\$ 192
For 90"W	0		A871090	A871090A	\$ 200
For 96"W**	0		A871096	A871096A	\$ 216
For 102"W	0		A8710102	A8710102A	\$ 219
For 108"W	0		A8710108	A8710108A	\$ 224
For 114"W	0		A8710114	A8710114A	\$ 233
For 126"W	0		A8710126	A8710126A	\$ 249
For 132"W	0		A8710132	A8710132A	\$ 256
For 138"W	0		A8710138	A8710138A	\$ 265
For 150"W	0		A8710150	A8710150A	\$ 281
For 156"W	0		A8710156	A8710156A	\$ 290
For 162"W	0		A8710162	A8710162A	\$ 297
For 168"W	0		A8710168	A8710168A	\$ 305
For 174"W	0		A8710174	A8710174A	\$ 314
For 180"W	0		A8710180	A8710180A	\$ 322
For 186"W	0		A8710186	A8710186A	\$ 330

<p><i>How to specify —</i> Select the Model Number from above.</p>	<p><i>1st Option:</i> Color: P Black</p>
--	--

A 8 | 7 | . | P |

Examples: A871018.P A871018A.P

Shippable by small-package carrier.

For specification information see pages 106-115.

GSA SIN 711-1

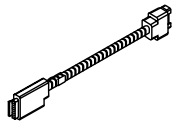

Description	Four-circuit 3 + 1 2 + 2	Three-circuit Separate Neutrals	List Price
Electrical Jumper Cables			
Up to 36"	A871336	A871336A [S]	\$ 114
Up to 66"	A871366	A871366A [S]	\$ 153
Up to 78"	A871378	A871378A [S]	\$ 194
Up to 108"	A8713108	A8713108A [S]	\$ 285
Up to 144"	A8713144	A8713144A [S]	\$ 290

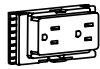

Duplex Receptacles (specify color)			
Circuit 1	A873501	A871501A [S]	\$ 42
Circuit 2	A873502	A871502A [S]	\$ 42
Circuit 3	A873503	A871503A [S]	\$ 42
Circuit 3 (2+2)	A873506	N/A [S]	\$ 42
Circuit 4 — iso/dedicated	A873504	N/A [S]	\$ 42
Circuit 1, 20 AMP	A871601	A871601A [S]	\$ 42

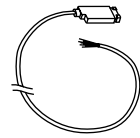

Electrical Power In-Feed Cables			
12' Seal-tight Power In-Feed	A877012	[S]	\$ 310

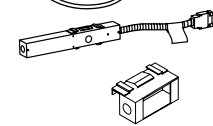

Hardwire Electrical			
Power In-Feed (New York)	A871400	A871400A [S]	\$ 243
Junction Box — Pack of 6 (Chicago Code)	Model 873600	[S]	\$ 661

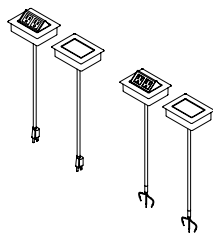

Description	Model	List Price
Wire Trough (for mounting on bottom of non-powered storage)		
15"W	KWM15 [S]	\$ 53
18"W	KWM18 [S]	\$ 58
24"W	KWM24 [S]	\$ 63
30"W	KWM30 [S]	\$ 69
36"W	KWM36 [S]	\$ 75
48"W	KWM48 [S]	\$ 86
60"W	KWM60 [S]	\$ 95
72"W	KWM72 [S]	\$ 106



Pop-Up Power Modules (replaces rectangular grommet in Involve powered tops)		
Corded Pop-Up Power Module — 2 Receptacles w/6' cord	S914P06GC [S]	\$ 266
Hardwire Pop-Up Power Module — 2 Receptacles w/6' cord	S914P06GH [S]	\$ 291



Grommet Kit for Involve (specify color)		
Rectangular Plastic Grommet	K6EGK [S]	\$ 25
Grommet Brush		
Brush Assembly for use with Grommet K6EGK	KGB [S]	\$ 49

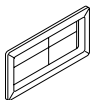

Wireway Grommet		
Pack of 6 (Black only)	TAWG [S]	\$ 108

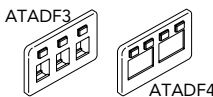

AMP Data Faceplates		
Three-Port Flex-Mode Faceplate Black (E4)	ATADF3 [S]	\$ 22
Four-Port Flex-Mode Faceplate Black (E4)	ATADF4 [S]	\$ 22

<p>How to specify — Select the Model Number from above.</p>	<p>1st Option: Color (if applicable): P Black</p>	<p>1st Option: Electrical Color for K6EGK (if applicable): See inside front cover for finishes.</p>	<p>1st Option: Color for AMP Faceplate (if applicable): E4 Black</p>
	P	E4	E4

Examples: A871636.P S914P06GC K6EGK.EY
KGB TAWG ATADF3.E4



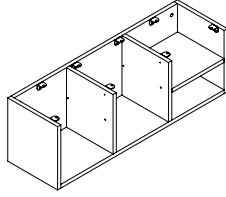

[S] Shippable by small-package carrier.

ALIGN METAL SPEC
ALIGN PRICING
ESSENTIALS SPEC
ESSENTIALS PRICING
VERTICALS
INVOLVE SPEC
INVOLVE PRICING
ALIGN VENEER

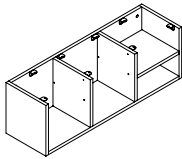

Cubby Laminate Storage

- Cubby storage units are 40"W x 13"H x 11¼"D (outside dimensions).
- Cubby units include three equal-sized compartments with interior dimensions of 12¼"W x 12"H x 11"D and include one shelf to separate one compartment into two — a 5¾"H upper compartment and 5⅝" lower compartment.
- Shelf can be located in any of the 3 openings.
- Specify optional shelf ASCSHELF for additional separation of cubby compartments.
- Cubby storage units are for mounting under worksurfaces 42"W or larger.
- Units include attaching hardware.
- Mounts under a 12"D or 24"D properly supported worksurface.
- Cubby units are constructed of ¾" thick particle board core with surfaces finished in laminate.
- Laminate option is limited to LM14 Frosty White.
- Cubby storage ships flat for field assembly.

	Description	Model	List Price
	Cubby Laminate Storage		
	40"W x 13"H x 11¼"D	ASC42 	\$ 712
	Cubby Shelves		
	Cubby Laminate Shelf, 2 Pack	ASCHELF 	\$ 130

<p>How to specify — Select the Model Number from above.</p>	<p><i>1st Option:</i> Laminate LM14 Frosty White</p>
--	---

_____ . **LM14**

Example: ASC42.LM14

 Shippable by small-package carrier.

Align™ Veneer Storage

Storage Overview	10
Pull Option Matrix.....	11
Align Veneer Statement of Line.....	16
<i>Working With Align Veneer Storage —</i>	
<i>Specification Information</i>	
Working with Align Veneer Personal Storage	160-161
Working with Align Veneer Pedestals	162-163
Working with Align Veneer Personal Files.....	163
Working with Align Veneer Towers.....	163
Working with Align Veneer Shared Storage.....	164
Working with Align Veneer Laterals.....	165
Working with Align Veneer Combination Files	166
Working with Align Veneer Bookcases	167
Working with Align Veneer Accessories	167
<i>Align Veneer Case Personal Storage — Pricing Information</i>	
Support and Mobile Pedestals	168-170
Personal Files.....	171
Personal Towers	172
<i>Align Veneer Case Shared Storage — Pricing Information</i>	
Lateral Files	173-175
Combination Files	176-178
Bookcases	179
<i>Align Veneer Accessories — Pricing Information</i>	
Pedestal and Lateral Accessories.....	179

Veneer Finishes

Stratawood veneer has a consistent straight-grain pattern. Natural veneer features variations in grain pattern and tone.

File and Box Drawers

Full extension file and box drawers glide easily on steel ball-bearing suspensions; allows complete access to drawer contents with a quiet drawer motion.

Filing

File drawers can accommodate front-to-back filing. File compressors come standard.

Full Front Drawer Design

Drawer front is square and extends fully across the case.

Aesthetic Alignment

Drawer alignment matches Align storage units.

Locking System

Direct-linkage lock system features heavy-gauge steel for security and reliability.

Core Removable Locks

Master-keyed core removable lock feature allows key numbers to be easily changed in the field and facilitates one-key access.

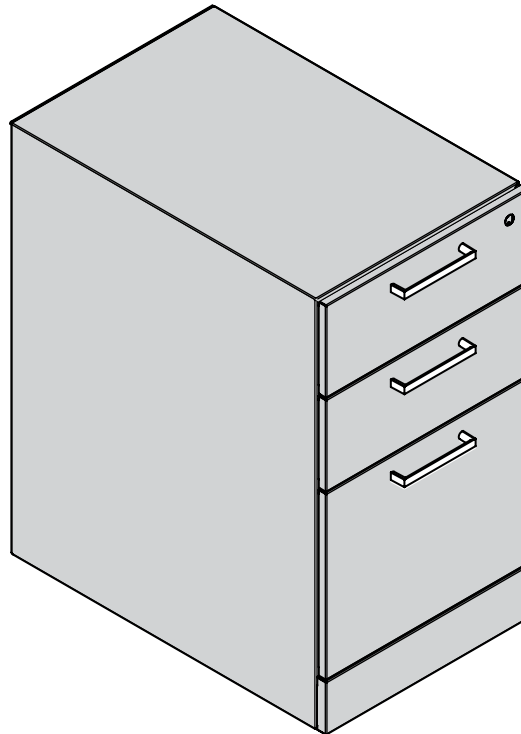

Omit Lock Core

Files can be shipped with lock cores removed; cores can then be installed after files are placed. Laterals can be keyed alike with pedestals and overhead cabinets.

Mobile Pedestals

Mobile pedestals provide flexible storage and can be nested under worksurfaces. (Take into consideration when planning offices which may have uneven floors.)

Support Pedestals

Support pedestals can support one end of a panel-attached worksurface, in lieu of other worksurface supports, and can be used to support worksurfaces in desk applications. Drawers align with laterals.

Depth

Pedestals are 24" and 30"D to be used with Align worksurfaces. Pedestal placement may affect access to receptacles in base pathway and worksurface grommets.

Three Pull Styles

Choice of three pull styles, also available on pedestals and laterals, allows for total design coordination on projects.

Landscape™ Fronts

Optional Landscape drawer fronts available.

Aesthetic Alignment

Drawer alignment matches Align lateral files.

Full Front Drawer Design

Drawer front extends fully across the case.

Three Pull Styles

Choice of three pull styles, also available on pedestals and laterals, allows for total design coordination on projects.

Suspension

Extra heavy-duty, telescoping ball-bearing slides. Partially open drawers will automatically retract when other drawers are opened due to the interlock being incorporated into the slides.

Omit Lock Core

Files can be shipped with lock cores removed; cores can then be installed after files are placed. Laterals can be keyed alike with pedestals and overhead cabinets.

Veneer Finishes

Stratawood veneer has a consistent straight-grain pattern. Natural veneer features variations in grain pattern and tone.

Core Removable Locks

Core removable lock feature allows key numbers to be easily changed in the field. It also facilitates installation.

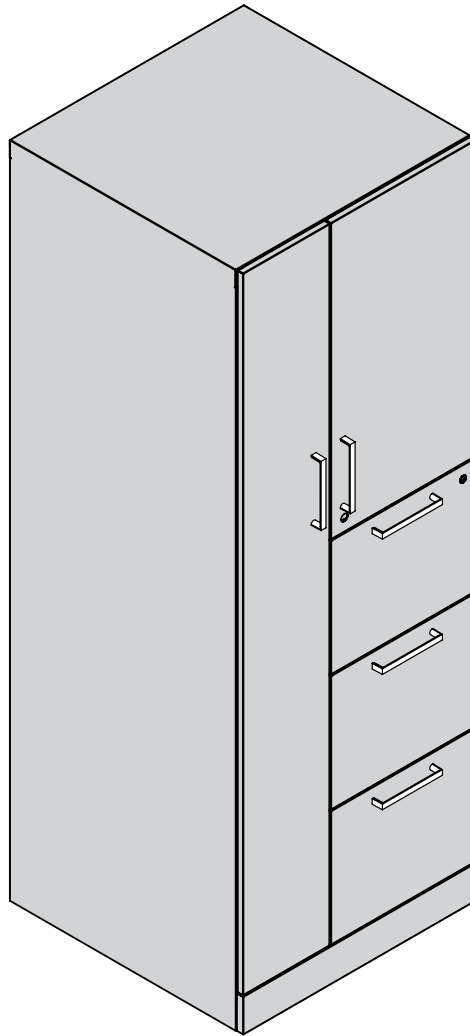

Align Personal Tower

Locking

Units have two locks. One secures non-wardrobe door and the other secures all drawers. Wardrobe door does not lock.

European Hinges

Wardrobe and cabinet door both contain European-style hinged door.

Filing

File drawers can accommodate front-to-back filing. File compressors come standard.

Four Hex-head Leveling Glides

Leveling glides can be adjusted from the outside of the case. Because of the stem, leveling can be done even when the file is fully loaded. Range is 2 3/4".

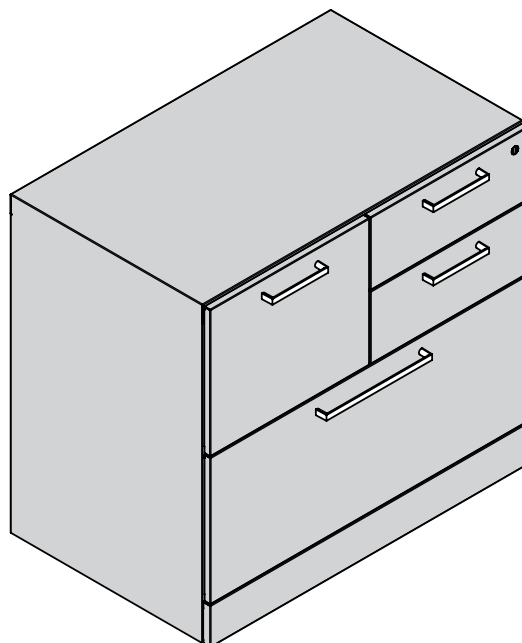

Align Personal File

Lateral File Drawers

Lateral file drawers contain dual-side locking drawers lock on both sides to prevent being pried open. Lateral drawers also have dual interlock which inhibits roll out of more than one drawer, either sequentially or simultaneously.

File and Box Drawers

Single-side locking drawers lock on one side to prevent being pried open. These drawers also have single interlock which inhibits roll out of more than one drawer, either sequentially or simultaneously.

Four Hex-head Leveling Glides

Leveling glides can be adjusted from outside or inside the case. Because of the hex-head design of the stem, leveling can be done even when the file is fully loaded. Range is 2 3/4".

Hanging Frames

Side-to-side and front-to-back filing comes standard in lateral drawer.

Align Veneer Support and Mobile Pedestals

- Veneer pedestals by Gunlocke®.
- Stratawood veneer has a consistent straight-grain pattern.
- Natural veneer will have cathedrals and as a natural material is subject to nature's quality control with variations in grain pattern and tone.
- Chassis: ¾" thick, 3-ply panels, vertical grain.
- Drawers: Finished hardwood interiors, 5-sided, chuck and bore construction.
- Suspensions: Ball-bearing suspensions, full-extension file drawers.

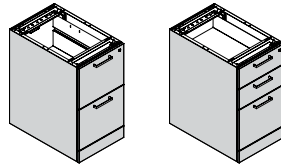

Align Veneer Support Pedestals (pages 168-170)

- Drawer fronts: Vertically matched veneer. Three pulls available — arch, square, and "J".
- Locking: Factory-installed locks standard.
- To allow clearance under worksurfaces, an Align mobile pedestal is 1½" shorter than an equivalent Align support pedestal. This, combined with the leveling range of Align support pedestals, personal files, towers, and laterals, will result in an offset of horizontal drawer reveals of 1½" to 3".
- Pedestals are not intended for freestanding applications.
- 28"H pedestal can be used to support a worksurface at 29½"H.
- Cannot convert veneer front pedestals to accept Landscape fronts in the field. Order Landscape™ ready veneer support pedestals.

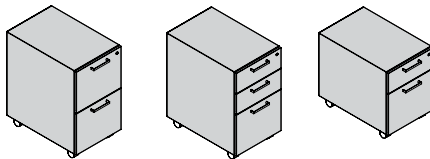

Align Veneer Mobile Pedestals (pages 168-170)

- Drawer fronts: Vertically matched veneer. Three pulls available — Arch, Square and "J".
- Locking: Factory-installed locks standard.
- Casters: 2½" dual wheel, black only.
- Pedestal has the ability to nest under worksurface.
- To allow clearance under worksurfaces, an Align mobile pedestal is 1½" shorter than an equivalent Align support pedestal. This, combined with the leveling range of Align support pedestals, personal files, towers, and laterals, will result in an offset of horizontal drawer reveals of 1½" to 3".
- Cannot convert veneer front pedestals to accept Landscape fronts in the field. Order Landscape ready veneer mobile pedestals.

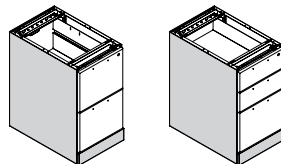

Align Veneer Support Pedestals — Ready for Landscape Drawers (page 169)

- Drawer fronts: Order Landscape drawer fronts separately
- Two pulls available — arch and square.
- 28⅞"H pedestal can be used to support a worksurface at 29½"H.
- Landscape front pedestals are equipped with special drawer bodies to accept Landscape fronts.
- Pedestals are not intended for freestanding applications.

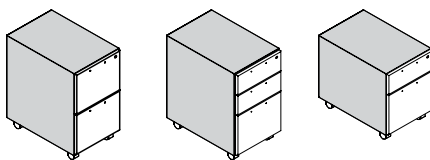

Align Veneer Mobile Pedestals — Ready for Landscape Drawers (page 169)

- Tops: ¾" thick, inset top.
- Drawer fronts: Order Landscape drawer fronts separately.
- Two pulls available — arch and square.
- Suspensions: Ball-bearing suspensions, full-extension file drawers.
- Casters: 2½" dual wheel, black only.
- Pedestal has the ability to nest under worksurface.
- To allow clearance under worksurfaces, an Align mobile pedestal is 1½" shorter than an equivalent Align support pedestal. This, combined with the leveling range of Align support pedestals, personal files, towers, and laterals, will result in an offset of horizontal drawer reveals of 1½" to 3".
- Landscape front pedestals are equipped with special drawer bodies to accept Landscape fronts.

Align Landscape Drawer Fronts for Veneer Pedestals, Veneer Personal Files and Veneer Personal Towers

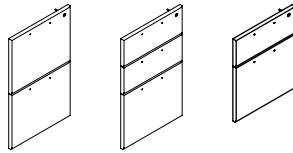

Align Landscape Drawer Fronts for Veneer Pedestals (page 170)

- Drawer front sets are for veneer case mobile and support pedestals.
- Core removable locks are standard.
- Landscape drawer frame available painted or anodized with Matte Silver finish.
- Includes attachment hardware.
- Landscape fronts ship and install separately from pedestal.
- Cannot convert standard veneer front drawer bodies to accept Landscape fronts in the field.
- Infinite Spectrum™ is a color-matched 100% recyclable polyester resin material.
- Sample kit required to confirm PANTONE® color meets expectations.
- Review of PANTONE sample and customer approval required prior to order entry.
- Specify PANTONE color using a PANTONE print or paints and interiors color guide number or PANTONE MATCHING SYSTEM®. When using the print color guide, use the uncoated (U) color references, metallics are not available; or use the architecture and interior color guide.
- Visit pantone.com for additional PANTONE information.

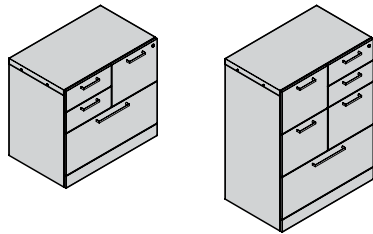

Align Veneer Personal Files (page 171)

- Veneer personal files by Gunlocke®.
- Stratawood veneer has a consistent straight-grain pattern.
- Natural veneer will have cathedrals and as a natural material is subject to nature's quality control with variations in grain pattern and tone.
- Drawer interlock mechanism.
- Freestanding or worksurface supporting.
- Drawer fronts: Vertically matched veneer.
- Three pulls available — arch, square, and “J”.
- Tops: ¾" thick, inset top.
- Chassis: ¾" thick, 3-ply panels, vertical grain, fully finished back.

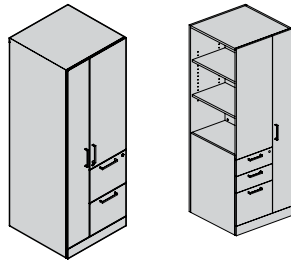

Align Veneer Personal Towers (page 172)

- Tops: ¾" thick, inset top.
- Chassis: ¾" thick, 3-ply panels, vertical grain, fully finished back.
- Drawers: Finished interiors, 5-sided, chuck and bore construction.
- Cabinet fronts: Vertically matched veneer. Three pulls available — arch, square, and “J”.
- Locking: Non-wardrobe door locks independently from drawers. Personal towers have 2 locks. Personal side access towers have one lock.
- Wardrobe doors do not lock.
- Glides: 2¾" adjustment.
- Shelves (quantity 2): ¾" thick, adjustable in 1¼" increments.

Dual-side Locking

Drawers and doors lock on both sides to prevent being pried open. The locking system is enclosed within the case to hide mechanisms which can snag and scratch. This feature is not found on most other manufacturers' files.

Dual Interlock

This mechanism inhibits roll out of more than one drawer, either sequentially or simultaneously.

Four Hex-head Leveling Glides

Leveling glides can be adjusted from inside the case. Because of the hex-head design of the stem, leveling can be done even when the file is fully loaded. Range is 1/8".

Suspension

Extra heavy-duty, telescoping, ball-bearing slides. Partially open drawers will automatically retract when other drawers are opened due to the interlock being incorporated into the slides.

Hanging Frames

Front-to-back and side-to-side are both standard. For front-to-back filing, backs should be set on rear position for maximum storage capacity.

Core Removable Lock

Core removable lock feature allows key numbers to be easily changed in the field. It also facilitates installation.

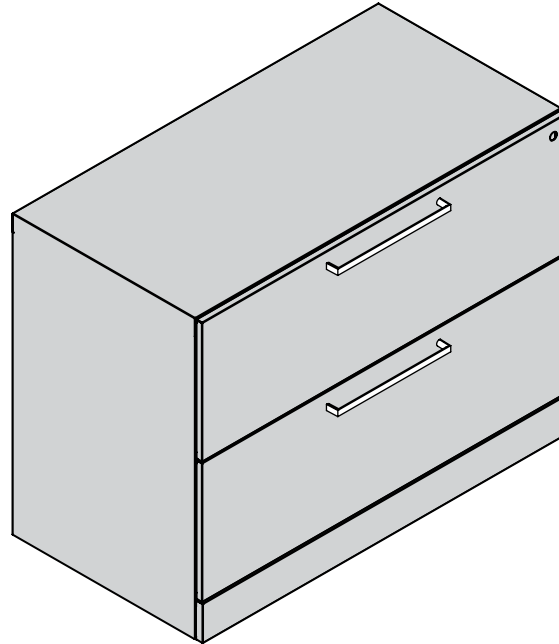

Omit Lock Core

Files can be shipped with lock cores removed; cores can then be installed after files are placed. Laterals can be keyed alike with pedestals and overhead cabinets.

Full Front Drawer Style

Features core removable lock located in top drawer on the right. Hinged doors lock located in right door in lower left hand corner.

Front Drawer Options

Optional Landscape™ front available on laterals.

Pull Styles

Choice of three pull styles, also available on pedestals, allows for total design coordination on projects.

Counterweight Kit

Veneer case units feature built in counterweights.

Veneer Finish

Stratawood veneer has a consistent straight-grain pattern. Natural veneer features variations in grain pattern and tone.

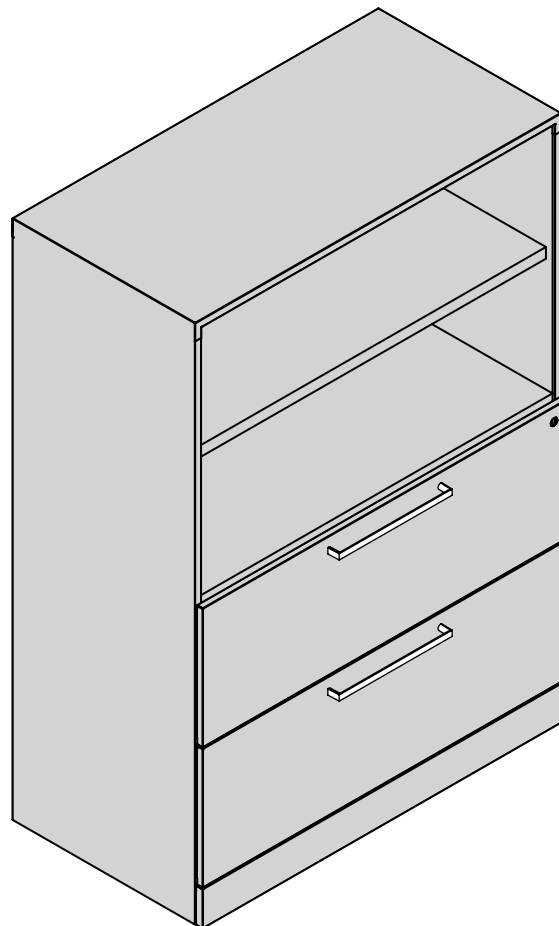

Align Veneer Lateral Files

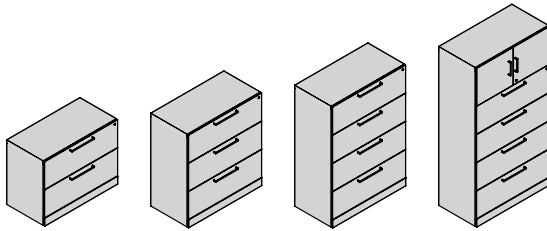

Align Veneer Lateral Files (page 173)

- Tops: 3/4" thick, inset top.
- Chassis: 3/4" thick, 3-ply panels, vertical grain, fully finished back.
- Lateral filing: Side-to-side letter and legal filing standard (rail provided). Front-to-back filing with optional file bars.
- Drawers: Finished interiors, 5-sided, chuck and bore construction.
- Laterals are 20" D.
- Drawer fronts: Vertically matched veneer.
- Three pull options: arch in Matte Silver, Bronze, or Black, square in Matte Silver, J in Matte Silver or Black.
- Suspensions: Ball-bearing suspensions, full-extension file drawers.
- Locking: Factory-installed locks standard.
- Glides: 1 1/8" adjustment.
- Extend glides on 2-high files 3/4" to align with support pedestals.
- Hinged Doors: Touch latch.
- 5-high top section is hinged door cabinet with lock at bottom of doors. Drawers lock independently with lock located at top of fourth drawer.
- Cannot convert standard veneer front lateral files to accept Landscape™ fronts in the field.
- 2-, 3-, and 4-high units have one lock. 5-high units have two locks.

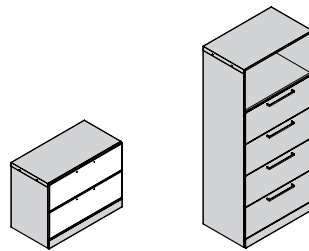

Align Veneer Lateral Files — Landscape Ready (pages 174-175)

- Veneer lateral file case ready for Landscape drawer/door fronts.
- Tops: 3/4" thick, inset top.
- Chassis: 3/4" thick, 3-ply panels, vertical grain, fully finished back.
- Lateral filing: Side-to-side letter and legal filing standard (rail provided). Front-to-back filing with optional file bars.
- Drawers: Finished interiors, 5-sided, chuck and bore construction.
- Drawer fronts: Must order Landscape drawer fronts separately.
- Two pull options: arch in Matte Silver and Black, square in Matte Silver.
- Suspensions: Ball-bearing suspensions, full-extension file drawers.
- Glides: 1 1/8" adjustment.
- 2-high lateral is ready for Landscape drawer fronts.
- 5-high top section is ready for Landscape hinged doors; lateral drawers are veneer.
- Landscape drawers/doors do not lock.
- Landscape front 2-high lateral files are equipped with special drawer bodies to accept Landscape fronts.

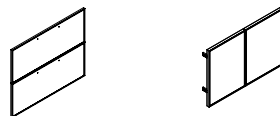

Align Landscape Drawer and Door Fronts for Veneer Laterals (pages 174-175)

- Drawer and door front sets are for veneer case lateral files.
- Landscape frame available painted or anodized with Matte Silver finish.
- Includes attachment hardware.
- Landscape fronts ship and install separately from lateral.
- Cannot convert standard veneer front drawer bodies to accept Landscape fronts in the field.
- Infinite Spectrum™ is a color-matched 100% recyclable polyester resin material.
- Specify PANTONE® color using a PANTONE print or paints and interiors color guide number or PANTONE MATCHING SYSTEM®. When using the print color guide, use the uncoated (U) color references, metallics are not available; or use the architecture and interior color guide.
- Visit pantone.com for additional PANTONE information.
- Sample kit required to confirm PANTONE color meets expectations.
- Review of PANTONE sample and customer approval required prior to order entry. Allsteel is not responsible for PANTONE matching. It is the sole responsibility of the dealer and/or customer to ensure PANTONE color is correct. To ensure matching order Infinite Spectrum Sample Kit model TN4SPSK prior to order entry.

Load Capacities (per current ANSI/BIFMA standards)

Align™ Veneer		
Opening Height	30" Wide	36" Wide
12"	150 lbs.	150 lbs.

Inside File Clearance Dimensions for Shelves and Drawers

	12" Height	Width		Max. Depth
		30"	36"	
Fixed Shelf	15 1/16"	28 3/4"	34 1/4"	18 1/2"
Roll-out Drawer	10 1/2"	26 3/4"	32 1/4"	14 15/16"

Align Veneer Combination Files

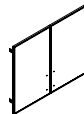
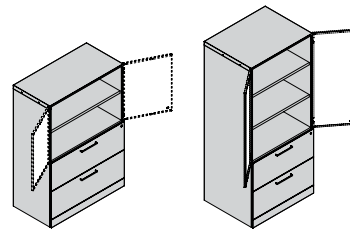
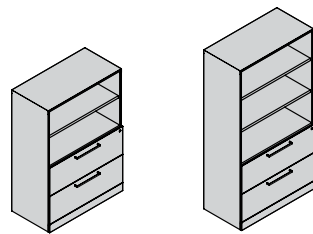
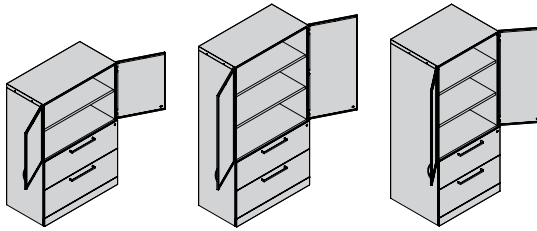
**Align Veneer Combination Files** (page 176)

- Tops: ¾" thick, inset top.
- Chassis: ¾" thick, 3-ply panels, vertical grain, fully finished back.
- Drawers: Finished interiors, 5-sided, chuck and bore construction.
- Cabinet fronts: Vertically matched veneer.
- Three pull options: arch in Matte Silver, Bronze, or Black, square in Matte Silver, J in Matte Silver or Black.
- Lateral filing: Side-to-side letter and legal filing standard (rail included). Front-to-back filing with optional file bars.
- Locking: Locks standard on lateral drawers.
- Glides: 1⅛" adjustment.
- Shelves: ¾" thick, adjustable in 1¼" increments.
- Upper top section is hinged door cabinet with lock at bottom of doors. Drawers lock independently with lock located at top of upper drawer.

Align Veneer Open Combination Files (page 176)

- Tops: ¾" thick, inset top.
- Chassis: ¾" thick, 3-ply panels, vertical grain, fully finished back.
- Drawers: Finished interiors, 5-sided, chuck fully finished back.
- Cabinet fronts: Vertically matched veneer.
- Three pulls available — arch, square, and "J".
- Lateral filing: Side-to-side letter and legal filing standard (rail included). Front-to-back filing with optional file bars.
- Locking: Locks standard on lateral drawers.
- Glides: 1⅛" adjustment.
- Shelves: ¾" thick, adjustable in 1¼" increments.

Align Landscape Ready Veneer Combination Files (pages 177-178)

- Veneer combination file case ready for Landscape door fronts.
- Tops: ¾" thick, inset top.
- Chassis: ¾" thick, 3-ply panels, vertical grain, fully finished back.
- Drawers: Finished interiors, 5-sided, chuck and bore construction.
- Drawer fronts: Vertically matched veneer.
- Two pull options: arch in Matte Silver and Black, square in Matte Silver.
- Door fronts: Must order Landscape™ hinged doors separately.
- 4-high ships with one fixed and one adjustable shelf, 5-high ships with one fixed and two adjustable shelves.
- Adjustable shelves adjust in 1¼" increments.
- Lateral filing: Side-to-side letter and legal filing standard (rail included). Front-to-back filing with optional file bars.
- Locking: Locks standard on lateral drawers. Landscape doors do not lock.
- Glides: 1⅛" adjustment.

Align Landscape Door Fronts for Veneer Combination Files (pages 177-178)

- Door front sets are for veneer combination files.
- Landscape frame available painted or with Matte Silver finish (anodized).
- Includes attachment hardware.
- Landscape fronts ship and install separately from combination files.
- Infinite Spectrum™ is a color-matched 100% recyclable polyester resin material.
- Specify PANTONE® color using a PANTONE print or paints and interiors color guide number or PANTONE MATCHING SYSTEM®. When using the print color guide, use the uncoated (U) color references, metallics are not available; or use the architecture and interior color guide.
- Visit pantone.com for additional PANTONE information.
- Sample kit required to confirm PANTONE color meets expectations.
- Review of PANTONE sample and customer approval required prior to order entry. Allsteel is not responsible for PANTONE matching. It is the sole responsibility of the dealer and/or customer to ensure PANTONE color is correct. To ensure matching order Infinite Spectrum Sample Kit model TN4SPSK prior to order entry.

Align Bookcases and Accessories

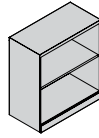

Align Bookcases (page 179)

- 30" W and 36" W.
- Cabinets are 20" deep.
- Adjustable shelves are 15¼"D, adjustable in 2" increments.
- 39½"H unit has 1 adjustable shelf.
- 51½"H unit has 2 adjustable shelves.
- 67¾"H unit has 3 adjustable shelves.
- Double-side wall construction.
- Laminate and veneer tops are available. Order 18" tops for freestanding applications and 18¾" tops when placing units next to lateral files with tops.

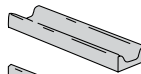

Pencil Tray (page 179)

- Solid hardwood with clear finish.

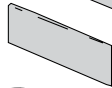

Box Drawer Divider (page 179)

- Hardwood with clear finish.

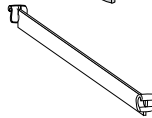

Filing Rails (page 179)

- Allow side-to-side filing in pedestals or front-to-back options in lateral file drawers. Rail hangs in clips from top edge of drawer.
- Two rails per package. Must order 1 package per drawer

Align™ Veneer Storage

Veneer Support and Mobile Pedestals

For specification information see pages 160-163.

GSA SIN 711-8



Description	Model	V1 List Price	V3 List Price	V5 List Price
Support Pedestal 28½"H — File/File — Veneer Case/Veneer Fronts				
24"D x 15⅞"W	YWIB-242 □	\$ 1550	\$ 1714	\$ 1915
30"D x 15⅞"W	YWIB-302 □	\$ 1649	\$ 1822	\$ 2035

Note: Order backs separately for desking applications. See below.



Support Pedestal 28½"H — Box/Box/File — Veneer Case/Veneer Fronts				
24"D x 15⅞"W	YWIB-243 □	\$ 1623	\$ 1794	\$ 2005
30"D x 15⅞"W	YWIB-303 □	\$ 1693	\$ 1870	\$ 2089

Note: Order backs separately for desking applications. See below.



Mobile Pedestal 26½"H — File/File — Veneer Case/Veneer Fronts				
24"D x 15⅞"W	YWMS-242 □	\$ 2120	\$ 2320	\$ 2594
30"D x 15⅞"W	YWMS-302 □	\$ 2311	\$ 2533	\$ 2826



Mobile Pedestal 26½"H — Box/Box/File — Veneer Case/Veneer Fronts				
24"D x 15⅞"W	YWMS-243 □	\$ 2190	\$ 2398	\$ 2675
30"D x 15⅞"W	YWMS-303 □	\$ 2355	\$ 2578	\$ 2880



Mobile Pedestal 20½"H — Veneer Case/Veneer Fronts				
24"D x 15⅞"W	YWMS-24B □	\$ 2028	\$ 2221	\$ 2481
30"D x 15⅞"W	YWMS-30B □	\$ 2218	\$ 2428	\$ 2714

Square pulls shown



Pedestal Back — Veneer for Veneer Support Pedestal Case				
28⅞"H x 15⅞"W	YPB29VV	\$ 495	\$ 540	\$ 606

How to specify — Select the Model Number from above.	1st Option: Pull:	2nd Option: Veneer Type and Finish:	3rd Option: Pull Color:	4th Option: Lock:	5th Option: Lock Color:
Y - . .	A Arch Pull S Square Pull J "J" Pull	See inside front cover for finishes.	Arch Pull E4 Black EL Matte Silver EZ Bronze Square Pull EL Matte Silver "J" Pull E4 Black EL Matte Silver	STD Standard OMT Omit Lock Core (Deduct \$18)	E4 Black EL Matte Silver

Example: YWIB-243S.NE800.EL.STDEL YWMS-243S.SE800.EL.STDEL

For specification information see pages 160-163.

GSA SIN 711-8, Type 2/3

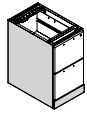

Description	Model	V1 List Price	V3 List Price	V5 List Price
Support Pedestal 28½"H — File/File — Ready for Drawer Fronts				
24"D x 15⅞"W	YWIB-242L □	\$ 1477	\$ 1556	\$ 1738
30"D x 15⅞"W	YWIB-302L □	\$ 1567	\$ 1646	\$ 1838

Note: Must specify Landscape drawer fronts separately. See page 405.
Order backs separately for desking applications.

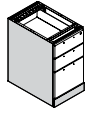

Support Pedestal 28½"H — Box/Box/File — Ready for Drawer Fronts				
24"D x 15⅞"W	YWIB-243L □	\$ 1546	\$ 1625	\$ 1815
30"D x 15⅞"W	YWIB-303L □	\$ 1611	\$ 1690	\$ 1885

Note: Must specify Landscape drawer fronts separately. See page 405.
Order backs separately for desking applications.

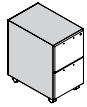

Mobile Pedestal 26½"H — File/File — Veneer Case/Ready for Landscape Drawer Fronts				
24"D x 15⅞"W	YWMS-242L □	\$ 2017	\$ 2095	\$ 2347
30"D x 15⅞"W	YWMS-302L □	\$ 2199	\$ 2277	\$ 2550

Note: Must specify Landscape drawer fronts separately. See page 405.



Mobile Pedestal 26½"H — Box/Box/File — Veneer Case/Ready for Landscape Drawer Fronts				
24"D x 15⅞"W	YWMS-243L □	\$ 2082	\$ 2161	\$ 2422
30"D x 15⅞"W	YWMS-303L □	\$ 2239	\$ 2318	\$ 2595

Note: Must specify Landscape drawer fronts separately. See page 405.



Mobile Pedestal 20½"H — Box/File — Veneer Case/Ready for Landscape Drawer Fronts				
24"D x 15⅞"W	YWMS-24BL □	\$ 1928	\$ 2006	\$ 2241
30"D x 15⅞"W	YWMS-30BL □	\$ 2110	\$ 2189	\$ 2444

Note: Must specify Landscape drawer fronts separately. See page 405.

<p>How to specify — Select the Model Number from above.</p>	<p>1st Option: Pull: A Arch S Square</p>	<p>2nd Option: Veneer Type and Finish: See inside front cover for finishes.</p>	<p>3rd Option: Pull Color: Arch Pull E4 Black EL Matte Silver Square Pull EL Matte Silver</p>
<p>Y - </p>	<p> .</p>	<p> .</p>	<p> </p>

Examples: YWIB-242LS.NC215.EL YWMS-302LA.SC701.EL

Align™ Veneer Storage

Landscape™ Drawer Fronts for Align™ Veneer Pedestals

For specification information see pages 160-163.

GSA SIN 711-3

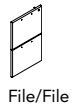

File/File

Description	Model	Core Paint P1 List Price	Select Paint P2 List Price	Anodized List Price
Infinite Spectrum™ Drawer Fronts for Veneer Pedestals — Ready for Drawer Fronts				
Set for File/File	YWLSF215SPL S	\$ 1083	\$ 1105	\$ 1372
Set for Box/Box File	YWLSF315SPL S	\$ 1452	\$ 1474	\$ 1847
Set for Box/File	YWLSFB15SPL S	\$ 1033	\$ 1055	\$ 1305
4" x 6" sample	YTSPSK*	\$ 52	—	—

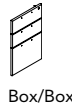

Box/Box/File

Foundation™ Drawer Fronts for Veneer Pedestals — Ready for Drawer Fronts				
Set for File/File	YWLSF215FDL S	\$ 1023	\$ 1045	\$ 1309
Set for Box/Box File	YWLSF315FDL S	\$ 1240	\$ 1262	\$ 1635
Set for Box/File	YWLSFB15FDL S	\$ 911	\$ 933	\$ 1181



Box/File

Pearlescent Strata™ Drawer Fronts for Veneer Pedestals — Ready for Drawer Fronts				
Set for File/File	YWLSF215PSL S	\$ 1124	\$ 1146	\$ 1411
Set for Box/Box File	YWLSF315PSL S	\$ 1482	\$ 1504	\$ 1876
Set for Box/File	YWLSFB15PSL S	\$ 1054	\$ 1076	\$ 1326

Quattro Drawer Fronts for Veneer Pedestals — Ready for Drawer Fronts				
Set for File/File	YWLSF215QUL S	\$ 1023	\$ 1045	\$ 1309
Set for Box/Box File	YWLSF315QUL S	\$ 1240	\$ 1262	\$ 1635
Set for Box/File	YWLSFB15QUL S	\$ 911	\$ 933	\$ 1181

*Allsteel is not responsible for PANTONE® matching. It is the sole responsibility of the dealer and/or customer to ensure PANTONE color is correct. To ensure matching order Infinite Spectrum Sample Kit model YTSPSK prior to order entry.

Note: Add Suffix "A" to model number for anodized instead of paint.

<p>How to specify — Select the Model Number from above.</p>	<p>1st Option: Paint (if applicable): C S See inside front cover for finishes.</p>	<p>2nd Option: PANTONE Color (if applicable): Use print or paints and interiors color guide number.</p>
<p>_____ . P _____ .</p>		<p>_____</p>

Continued below ▼

<p>2nd Option: Foundation Colors (if applicable): FD01 Sand FD02 Taupe FD03 Caramel FD04 Pure White FD05 Flint</p>	<p>2nd Option: Pearlescent Strata Color (if applicable): PS01 Glacier PS02 Shadow PS04 Shell PS05 Tortoise PS07 Quartz</p>	<p>2nd Option: Quattro Paper Color (if applicable): QU44 Platinum QU55 Carbon QU66 White</p>	<p>3rd Option: Lock: STD Standard OMT Omit Lock Core (Deduct \$18)</p>	<p>4th Option: Lock Color: E4 Black EL Matte Silver</p>
<p>F D 0 _____</p>	<p>P S 0 _____</p>	<p>Q U _____</p>	<p>_____</p>	<p>E _____</p>

Examples: YWLSF315FDLA.FD01.STDEL
YWLSFB15PSL.P02.PS02.STDE4

S Shippable by small-package carrier.

Align™ Veneer Storage

Veneer Personal Files

For specification information see pages 160-163.

GSA SIN 711-8

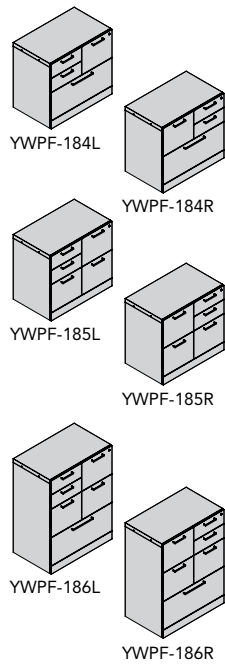

Description	Model	V1 List Price	V3 List Price	V5 List Price
27½"H Personal File — 30"W x 20"D — Veneer Case/Veneer Fronts – 2-High				
Box/Box/File / Lateral	YWPF-184L □	\$ 2732	\$ 2993	\$ 3342
File/Box/Box / Lateral	YWPF-184R □	\$ 2732	\$ 2993	\$ 3342
Box/Box/File/File/File	YWPF-185L □	\$ 2732	\$ 2993	\$ 3342
File/Box/Box/File/File	YWPF-185R □	\$ 2732	\$ 2993	\$ 3342
39½"H Personal File — 30"W x 20"D — Veneer Case/Veneer Fronts – 3-High				
Box/Box/File/File/File/Lateral	YWPF-186L □	\$ 3411	\$ 3736	\$ 4172
File/Box/Box/File/File/Lateral	YWPF-186R □	\$ 3411	\$ 3736	\$ 4172

<p>How to specify — Select the Model Number from above.</p>	<p><i>1st Option:</i> Pull: A Arch Pull S Square Pull J "J" Pull</p>	<p><i>2nd Option:</i> Veneer Type and Finish: See inside front cover for finishes.</p>	<p><i>3rd Option:</i> Pull Color: Arch Pull E4 Black EL Matte Silver EZ Bronze</p> <p>Square Pull EL Matte Silver</p> <p>"J" Pull E4 Black EL Matte Silver</p>	<p><i>4th Option:</i> Lock Type: STD Standard OMT Omit Lock Core (Deduct \$18)</p>	<p><i>5th Option:</i> Lock Color: E4 Black EL Matte Silver</p>
Y	.		E .		

Example: YWPF-184RA.NC215.E4.STDE4

Align™ Veneer Storage

Veneer Personal Towers

For specification information see pages 160-163.

GSA SIN 711-8

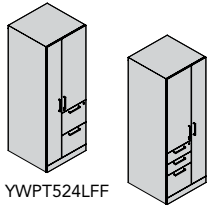

YWPT524LFF

YWPT524RBBF

Description	Model	V1 List Price	V3 List Price	V5 List Price
67%⁵ H Personal Towers — 24"W x 24"D — Veneer Case/Veneer Fronts				
Wardrobe Left/File/File	YWPT524LFF □	\$ 7104	\$ 7789	\$ 8698
Wardrobe Right/File/File	YWPT524RFF □	\$ 7104	\$ 7789	\$ 8698
Wardrobe Left/Box/Box/File	YWPT524LBBF □	\$ 7104	\$ 7789	\$ 8698
Wardrobe Right/Box/Box/File	YWPT524RBBF □	\$ 7104	\$ 7789	\$ 8698

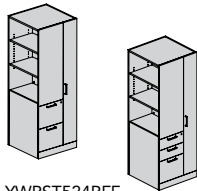

YWPST524RFF

YWPST524RBBF

67%⁵ H Personal Side Access Towers — 24"W x 24"D — Veneer Case/Veneer Fronts				
Wardrobe Left/File/File	YWPST524LFF □	\$ 7104	\$ 7693	\$ 8474
Wardrobe Right/File/File	YWPST524RFF □	\$ 7104	\$ 7693	\$ 8474
Wardrobe Left/Box/Box/File	YWPST524LBBF □	\$ 7104	\$ 7789	\$ 8698
Wardrobe Right/Box/Box/File	YWPST524RBBF □	\$ 7104	\$ 7789	\$ 8698

<p>How to specify — Select the Model Number from above.</p> <p>Y _____ .</p>	<p>1st Option: Pull: A Arch Pull S Square Pull J "J" Pull</p> <p>_____ .</p>	<p>2nd Option: Veneer Type and Finish: See inside front cover for finishes.</p> <p>_____ .</p>	<p>3rd Option: Pull Color: Arch Pull E4 Black EL Matte Silver EZ Bronze</p> <p>Square Pull EL Matte Silver</p> <p>"J" Pull E4 Black EL Matte Silver</p> <p>E _____ .</p>	<p>4th Option: Lock Type: STD Standard OMT Omit Lock Core (Deduct \$18)</p> <p>_____</p>	<p>5th Option: Lock Color: E4 Black EL Matte Silver</p> <p>_____</p>
---	--	--	---	--	--

Example: YWPT524LFFS.NC215.E4.STDE4

Align™ Veneer Storage

Veneer Lateral Files

For specification information see pages 164-167.

GSA SIN 711-8

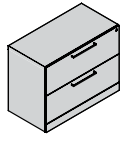

Description	Model	V1 List Price	V3 List Price	V5 List Price
27½"H Lateral Files — Veneer Case/Veneer Fronts – 2-High				
30"W x 20"D	YWFLF230 □	\$ 2320	\$ 2542	\$ 2838
36"W x 20"D	YWFLF236 □	\$ 2540	\$ 2781	\$ 3106



39½"H Lateral Files — Veneer Case/Veneer Fronts – 3-High				
30"W x 20"D	YWFLF330 □	\$ 2945	\$ 3223	\$ 3606
36"W x 20"D	YWFLF336 □	\$ 3224	\$ 3531	\$ 3944

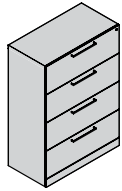

51½"H Lateral Files — Veneer Case/Veneer Fronts – 4-High				
30"W x 20"D	YWFLF430 □	\$ 4097	\$ 4490	\$ 5013
36"W x 20"D	YWFLF436 □	\$ 4444	\$ 4872	\$ 5442

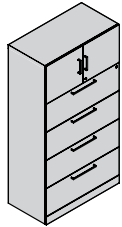

67½"H Lateral Files — Veneer Case/Veneer Fronts – 5-High				
30"W x 20"D	YWFLF530 □	\$ 5492	\$ 6019	\$ 6726
36"W x 20"D	YWFLF536 □	\$ 5901	\$ 6468	\$ 7228

ALIGN METAL SPEC
ALIGN PRICING
ESSENTIALS SPEC
ESSENTIALS PRICING
VERTICALS
INVOLVE SPEC
INVOLVE PRICING
ALIGN VENEER

How to specify — Select the Model Number from above.	1st Option: Pull: A Arch S Square J "J"	2nd Option: Veneer Type and Finish: See inside front cover for finishes.	3rd Option: Pull Color: Arch Pull E4 Black EL Matte Silver EZ Bronze Square Pull EL Matte Silver "J" Pull E4 Black EL Matte Silver	4th Option: Lock Type: STD Standard OMT Omit Lock Core (Deduct \$18 per lock)	5th Option: Lock Color: E4 Black EL Matte Silver
	YWF L F .				

Example: YWFLF336S.NE800.EL.STDEL

Align™ Veneer Storage

Veneer Lateral Files — Ready for Landscape™ Fronts

For specification information see pages 164-167.

GSA SIN 711-8

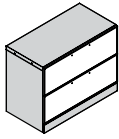

Description	Model	V1 List Price	V3 List Price	V5 List Price
27½"H — two 12" drawers with hanging frames side-to-side and front-to-back — Veneer Case/Ready for Landscape Drawer Fronts – 2-High				
30"W x 20"D	YWFLF230L □	\$ 2207	\$ 2313	\$ 2586
36"W x 20"D	YWFLF236L □	\$ 2417	\$ 2522	\$ 2795

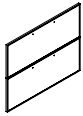

Description	Model	Core Paint P1 List Price	Select Paint P2 List Price	Anodized List Price
Infinite Spectrum Drawer Fronts for 27½"H Veneer Laterals — Ready for Landscape Drawer Fronts				
30"W	YWLSFLF230SP <input type="checkbox"/>	\$ 1199	\$ 1221	\$ 1510
36"W	YWLSFLF236SP <input type="checkbox"/>	\$ 1342	\$ 1364	\$ 1708
4" x 6" sample	YTSPSK* <input type="checkbox"/>	\$ 52	—	—
Foundation Drawer Fronts for 27½"H Veneer Laterals — Ready for Landscape Drawer Fronts				
30"W	YWLSFLF230FD <input type="checkbox"/>	\$ 1421	\$ 1443	\$ 1734
36"W	YWLSFLF236FD <input type="checkbox"/>	\$ 1627	\$ 1649	\$ 1992
Pearlescent Strata Drawer Fronts for 27½"H Veneer Laterals — Ready for Landscape Drawer Fronts				
30"W	YWLSFLF230PS <input type="checkbox"/>	\$ 1261	\$ 1283	\$ 1571
36"W	YWLSFLF236PS <input type="checkbox"/>	\$ 1421	\$ 1443	\$ 1788
Quattro Drawer Fronts for 27½"H Veneer Laterals — Ready for Landscape Drawer Fronts				
30"W	YWLSFLF230QU <input type="checkbox"/>	\$ 1421	\$ 1443	\$ 1734
36"W	YWLSFLF236QU <input type="checkbox"/>	\$ 1627	\$ 1649	\$ 1992

Note: Add Suffix "A" to model number for anodized instead of paint.

*Allsteel is not responsible for PANTONE® matching. It is the sole responsibility of the dealer and/or customer to ensure PANTONE color is correct. To ensure matching order Infinite Spectrum™ Sample Kit model YTSPSK prior to order entry.

LANDSCAPE SURFACE MATERIAL OPTIONS

Infinite Spectrum	Foundation™	Pearlescent Strata™	Quattro
Use print or paints and interiors color guide number.	FD01 Sand FD02 Taupe FD04 Pure White	PS01 Glacier PS02 Shadow PS04 Shell PS05 Tortoise PS07 Quartz	QU44 Platinum

<p>How to specify — Select the Model Number from above.</p>	<p>1st Option: Pull (if applicable): A Arch S Square</p>	<p>1st Option: Landscape Surface Material (if applicable):</p>	<p>2nd Option: Veneer Type and Finish (if applicable): See inside front cover for finishes.</p>	<p>2nd Option: Paint (if applicable): <input type="checkbox"/> <input type="checkbox"/> See inside front cover for finishes.</p>	<p>3rd Option: Pull Color: Arch Pull E4 Black EL Matte Silver EZ Bronze Square Pull EL Matte Silver</p>
<p>Examples: YWFLF236LA.SC777.E4 YWLSFLF230QU.QU44.P27 <input type="checkbox"/> Shippable by small-package carrier.</p>					

For specification information see pages 164-167.

GSA SIN 711-3

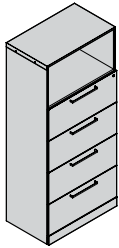

Description	Model	V1 List Price	V3 List Price	V5 List Price
67%¹H – 16" fixed shelf ready or Landscape hinged doors, balance are 12" drawers with hanging frames side-to-side — Veneer Case/Ready for Landscape Hinged Door Fronts – 5-High				
30"W x 20"D	YWFLF530L □	\$ 5496	\$ 5737	\$ 6062
36"W x 20"D	YWFLF536L □	\$ 5610	\$ 5851	\$ 6176

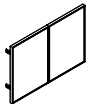

Description	Model	Core Paint P1 List Price	Select Paint P2 List Price	Anodized List Price
Infinite Spectrum Doors for 67%¹H Veneer Laterals — Ready for Landscape Door Fronts				
30"W	YWLSFLF530SP [S]	\$ 1119	\$ 1141	\$ 1382
36"W	YWLSFLF536SP [S]	\$ 1178	\$ 1200	\$ 1472
4" x 6" sample	YTSPSK* [S]	\$ 52	—	—
Foundation Doors for 67%¹H Veneer Laterals — Ready for Landscape Door Fronts				
30"W	YWLSFLF530FD [S]	\$ 770	\$ 792	\$ 1035
36"W	YWLSFLF536FD [S]	\$ 1119	\$ 1141	\$ 1415
Pearlescent Strata Doors for 67%¹H Veneer Laterals — Ready for Landscape Door Fronts				
30"W	YWLSFLF530PS [S]	\$ 1160	\$ 1182	\$ 1421
36"W	YWLSFLF536PS [S]	\$ 1221	\$ 1243	\$ 1517
Quattro Doors for 67%¹H Veneer Laterals — Ready for Landscape Door Fronts				
30"W	YWLSFLF530QU [S]	\$ 770	\$ 792	\$ 1035
36"W	YWLSFLF536QU [S]	\$ 1119	\$ 1141	\$ 1415

Note: Add Suffix "A" to model number for anodized instead of paint.

*Allsteel is not responsible for PANTONE® matching. It is the sole responsibility of the dealer and/or customer to ensure PANTONE color is correct. To ensure matching order Infinite Spectrum™ Sample Kit model YTSPSK prior to order entry.

LANDSCAPE SURFACE MATERIAL OPTIONS

Infinite Spectrum	Foundation™	Pearlescent Strata™	Quattro
<i>Use print or paints and interiors color guide number.</i>	FD01 Sand FD02 Taupe FD04 Pure White	PS01 Glacier PS02 Shadow PS04 Shell PS05 Tortoise PS07 Quartz	QU44 Platinum

How to specify — Select the Model Number from above.	1st Option: Pull: A Arch S Square	1st Option: Landscape Surface Material (if applicable):	2nd Option: Veneer Type and Finish:	2nd Option: Paint (if applicable): C S See inside front cover for finishes.	3rd Option: Pull Color (if applicable): Arch Pull: EL Matte Silver E4 Black Square Pull: EL Matte Silver	4th Option: Lock Type (if applicable): STD Standard Lock OMT Omit Lock Core (Deduct \$18)	5th Option: Lock Color (if applicable): E4 Black EL Matte Silver
_____ .	_____ .	_____ .	_____ .	P _____ .	E _____ .	_____ .	E _____ .

Examples: YWLSFLF530PS.PS01.P27 YWLSFLF536QUA.QU44

[S] Shippable by small-package carrier.

Align™ Veneer Storage

Veneer Combination Files

For specification information see pages 164-167.

GSA SIN 711-8

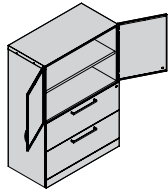

Exterior Width/Depth	Model	V1 List Price	V3 List Price	V5 List Price
51½"H Hinged Doors — top opening has hinged door with pull and lock; features one fixed shelf and one adjustable shelf; two 12" drawers at base with hanging frames side-to-side — Veneer Case/Veneer Fronts – 4-High				
30"W x 20"D	YWFCF430 □	\$ 4390	\$ 4814	\$ 5375
36"W x 20"D	YWFCF436 □	\$ 4852	\$ 5319	\$ 5939

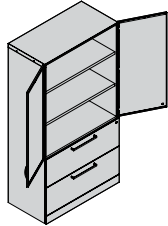

67"H Hinged Doors — top opening has hinged doors with pull and lock; features one fixed shelf and two adjustable shelves; two 12" drawers at base with hanging frames side-to-side — Veneer Case/Veneer Fronts – 5-High				
30"W x 20"D	YWFCF530 □	\$ 5121	\$ 5613	\$ 6270
36"W x 20"D	YWFCF536 □	\$ 5526	\$ 6060	\$ 6767

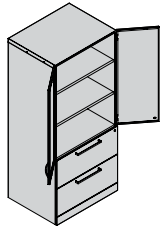

67"H Hinged Doors — top opening has hinged doors with pull and lock; features one fixed shelf and two adjustable shelves; two 12" drawers at base with hanging frames side-to-side — Veneer Case/Veneer Fronts – 5-High				
30"W x 24"D	YWFCF5302 □	\$ 5681	\$ 6231	\$ 6591
36"W x 24"D	YWFCF5362 □	\$ 6124	\$ 6714	\$ 7105

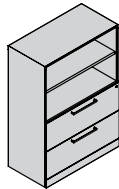

51"H Open Shelves — top opening has one fixed and one adjustable shelf; two 12" drawers at base with hanging frames side-to-side — Veneer Case/Veneer Fronts – 4-High				
30"W x 20"D	YWFC5430 □	\$ 2961	\$ 3241	\$ 3624
36"W x 20"D	YWFC5436 □	\$ 3268	\$ 3581	\$ 4001

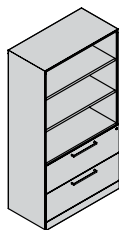

67"H Open Shelves — top opening has one fixed and two adjustable shelves; two 12" drawers at base with hanging frames side-to-side — Veneer Case/Veneer Fronts – 5-High				
30"W x 20"D	YWFC5530 □	\$ 4065	\$ 4453	\$ 4974
36"W x 20"D	YWFC5536 □	\$ 4458	\$ 4887	\$ 5458

How to specify — Select the Model Number from above. Y W F C F	1st Option: Pull: A Arch S Square J "J"	2nd Option: Veneer Type and Finish: See inside front cover for finishes.	3rd Option: Pull Color: Arch Pull E4 Black EL Matte Silver EZ Bronze Square Pull EL Matte Silver "J" Pull E4 Black EL Matte Silver	4th Option: Lock Type: STD Standard OMT Omit Lock Core (Deduct \$18 per lock)	5th Option: Lock Color: E4 Black EL Matte Silver
	.	.	. E		

Examples: YWFCF430J.RF357.E4.STDE4 YWFC5536A.NE800.EL.STDEL

For specification information see pages 164-167.

GSA SIN 711-8

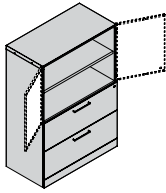

Description	Model	V1 List Price	V3 List Price	V5 List Price
51½"H — Veneer Case/Ready for Landscape Hinged Doors — Lateral/Lateral – 4-High				
30"W x 20"D	YWFCF430L □	\$ 4171	\$ 4368	\$ 4879
36"W x 20"D	YWFCF436L □	\$ 4610	\$ 4807	\$ 5368

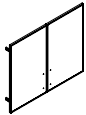

Description	Model	Core Paint P1 List Price	Select Paint P2 List Price	Anodized List Price
Infinite Spectrum Doors for 51½"H Veneer Combination Files — Ready for Landscape Door Fronts				
30"W	YWLSFCF430SP [S]	\$ 1138	\$ 1160	\$ 1436
36"W	YWLSFCF436SP [S]	\$ 1199	\$ 1221	\$ 1534
4" x 6" sample	YTSPSK* [S]	\$ 52	—	—
Foundation Doors for 51½"H Veneer Combination Files — Ready for Landscape Door Fronts				
30"W	YWLSFCF430FD [S]	\$ 1292	\$ 1314	\$ 1589
36"W	YWLSFCF436FD [S]	\$ 1364	\$ 1386	\$ 1697
Pearlescent Strata Doors for 51½"H Veneer Combination Files — Ready for Landscape Door Fronts				
30"W	YWLSFCF430PS [S]	\$ 1199	\$ 1221	\$ 1495
36"W	YWLSFCF436PS [S]	\$ 1261	\$ 1283	\$ 1593
Quattro Doors for 51½"H Veneer Combination Files — Ready for Landscape Door Fronts				
30"W	YWLSFCF430QU [S]	\$ 1342	\$ 1364	\$ 1641
36"W	YWLSFCF436QU [S]	\$ 1364	\$ 1386	\$ 1697

Note: Add Suffix "A" to model number for anodized instead of paint.

*Allsteel is not responsible for PANTONE® matching. It is the sole responsibility of the dealer and/or customer to ensure PANTONE color is correct. To ensure matching order Infinite Spectrum™ Sample Kit model YTSPSK prior to order entry.

LANDSCAPE SURFACE MATERIAL OPTIONS

Infinite Spectrum	Foundation™	Pearlescent Strata™	Quattro
Use print or paints and interiors color guide number.	FD01 Sand FD02 Taupe FD04 Pure White	PS01 Glacier PS02 Shadow PS04 Shell PS05 Tortoise PS07 Quartz	QU44 Platinum

How to specify — Select the Model Number from above.	1st Option: Pull (if applicable): A Arch S Square	1st Option: Landscape Surface Material (if applicable):	2nd Option: Veneer Type and Finish: See inside front cover for finishes.	2nd Option: Paint (if applicable): C S See inside front cover for finishes.	3rd Option: Pull Color: Arch Pull E4 Black EL Matte Silver EZ Bronze Square Pull EL Matte Silver	4th Option: Lock Type (if applicable): STD Standard OMT Omit Lock Core (Deduct \$18)	5th Option: Lock Color (if applicable): E4 Black EL Matte Silver
_____ . _____	_____ . _____	_____ . _____	_____ . _____	_____ . _____	_____ . _____	_____ . _____	_____ . _____

Examples: YWFCF430LS.NC215.EL.STDEL YWLSFCF436FDA.FD02 YWLSFCF430QU.QU66.PR2

[S] Shippable by small-package carrier.

Align™ Veneer Storage

Veneer Combination Files — Ready for Landscape™ Doors

For specification information see pages 164-167.

GSA SIN 711-3

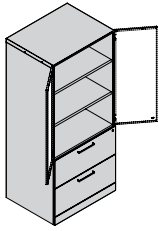

Description	Model	V1 List Price	V3 List Price	V5 List Price
67%³H — Veneer Case/Ready for Landscape Hinged Doors — Lateral/Lateral – 5-High				
30"W x 20"D	YWFCF530L □	\$ 4867	\$ 5109	\$ 5707
36"W x 20"D	YWFCF536L □	\$ 5248	\$ 5490	\$ 6134
67%³H — Veneer Case/Ready for Landscape Hinged Doors — Lateral/Lateral – 5-High				
30"W x 24"D	YWFCF530L2 □	\$ 5398	\$ 5640	\$ 6300
36"W x 24"D	YWFCF536L2 □	\$ 5818	\$ 6060	\$ 6771

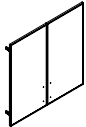

Description	Model	Core Paint P1 List Price	Select Paint P2 List Price	Anodized List Price
Infinite Spectrum Doors for 67%³H Veneer Combination Files — Ready for Landscape Door Fronts				
30"W	YWLSFCF530SP [S]	\$ 1751	\$ 1773	\$ 2147
36"W	YWLSFCF536SP [S]	\$ 1834	\$ 1856	\$ 2301
4" x 6" sample	YTSPSK* [S]	\$ 52	—	—
Foundation Doors for 67%³H Veneer Combination Files — Ready for Landscape Door Fronts				
30"W	YWLSFCF530FD [S]	\$ 1871	\$ 1893	\$ 2267
36"W	YWLSFCF536FD [S]	\$ 2120	\$ 2142	\$ 2587
Pearlescent Strata Doors for 67%³H Veneer Combination Files — Ready for Landscape Door Fronts				
30"W	YWLSFCF530PS [S]	\$ 1913	\$ 1935	\$ 2307
36"W	YWLSFCF536PS [S]	\$ 1998	\$ 2020	\$ 2464
Quattro Doors for 67%³H Veneer Combination Files — Ready for Landscape Door Fronts				
30"W	YWLSFCF530QU [S]	\$ 1871	\$ 1893	\$ 2267
36"W	YWLSFCF536QU [S]	\$ 2120	\$ 2142	\$ 2587

Note: Add Suffix "A" to model number for anodized instead of paint.

*Allsteel is not responsible for PANTONE® matching. It is the sole responsibility of the dealer and/or customer to ensure PANTONE color is correct. To ensure matching order Infinite Spectrum™ Sample Kit model YTSPSK prior to order entry.

LANDSCAPE SURFACE MATERIAL OPTIONS

Infinite Spectrum <i>Use print or paints and interiors color guide number.</i>	Foundation™ FD01 Sand FD02 Taupe FD04 Pure White	Pearlescent Strata™ PS01 Glacier PS02 Shadow PS04 Shell PS05 Tortoise PS07 Quartz	Quattro QU44 Platinum
--	--	---	---------------------------------

How to specify — Select the Model Number from above.	1st Option: Pull (if applicable): A Arch S Square	1st Option: Landscape Surface Material (if applicable):	2nd Option: Veneer Type and Finish: See inside front cover for finishes.	2nd Option: Paint (if applicable): C S See inside front cover for finishes.	3rd Option: Pull Color: Arch Pull E4 Black EL Matte Silver EZ Bronze Square Pull EL Matte Silver	4th Option: Lock Type (if applicable): STD Standard OMT Omit Lock Core (Deduct \$18)	5th Option: Lock Color (if applicable): E4 Black EL Matte Silver
_____ . _____ .	_____ .	_____ .	_____ .	P _____	_____	_____	_____

Examples: YWFCF530LS.NC215.EL.STDEL YWLSFCF530PS.PS02.PR3 [S] Shippable by small-package carrier.

Align™ Veneer Storage

For specification information see page 167.

GSA SIN 711-3, 711-8

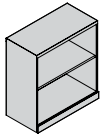

YWBK330

Description	Model	Number of Adj. Shelves	V1 List Price	V3 List Price	V5 List Price
Bookcases — 30"W x 20"D — Veneer					
39½"H	YWBK330	2	\$ 2437	\$ 2788	\$ 3112
52½"H	YWBK430	3	\$ 2771	\$ 3168	\$ 3542
67⅝"H	YWBK530	4	\$ 3411	\$ 3904	\$ 4361

Description	Model	Number of Adj. Shelves	V1 List Price	V3 List Price	V5 List Price
Bookcases — 36"W x 20"D — Veneer					
39½"H	YWBK336	2	\$ 2703	\$ 3091	\$ 3452
52½"H	YWBK436	3	\$ 3138	\$ 3591	\$ 4008
67⅝"H	YWBK536	4	\$ 3817	\$ 4368	\$ 4878

ALIGN – Veneer

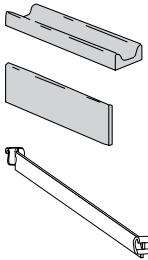

Description	Model	Dimensions	List Price
Pedestal and Lateral Accessories			
Pencil Tray	WTR	3"D x 11⅞"W x 1¼"H	\$ 136
Box Drawer Divider	WBD	⅞"D x 11⅞"W x 3½"H	\$ 85
Pedestal			
Side-to-side Filing Rails	WPR	⅞"D x 11⅜"W x 1"H	\$ 35
Lateral File			
Front-to-back Filing Rails	WLR	⅞"D x 14⅜"W x 1"H	\$ 35

Note: 2 rails per package. 2 rails required per drawer lateral file.

<p>How to specify — Select the Model Number from above.</p>	<p><i>1st Option:</i> Veneer Type and Finish (if applicable): See inside front cover for finishes.</p>
--	---

Examples: YWBK336.NE800 WTR WLR

Shippable by small-package carrier.

Laterals, Pedestals and Storage, Painted Wood Storage

Standard Options

- Random Keying — The factory will assign key(s) arbitrarily using key numbers from chart below.
- Omit Lock Core — The factory will omit lock cores. Removable lock core kits with specific key number must be ordered to facilitate keying alike in the field.

Vertical Files

Standard Options

- Random Keying — The factory will assign key(s) arbitrarily (see below chart for key numbers).

Key Alike Process









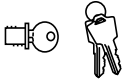

- Order standard product which will be shipped with factory installed locks and random numbered cores.
- Order the appropriate quantity of like numbered cores required for each workstation or keyed area.
- Simply replace the factory installed core with the replacement cores after product has been installed.

Replacing Lock Cores

- Lock must be in the unlocked position.
- Insert core removal key and pull core straight out. (Reach units require rotating key 90° clockwise past unlocked position.)
- Insert new core with core removable key, hold core into lock and withdraw core removal key.
- Retain original core for future use.
- On Persona™ Pedestals, open top drawer and hold lock bars in unlocked position before removal of core.

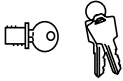
	Random Keying	Omit Lock Core	Key Numbers	Lock Core Kit	Master Key
Align™ Hutches	X	X	101E-225E	ALKF23C*	AMKF22
Align Laterals	X	X	101E-225E	ALKF23C*	AMKF22
Align New Low Credenzas, Towers, Pedestals (“YP” prefix models)	X	X	101E-225E	ALKF26EL	AMKF22
Align Overheads	X	X	101E-225E	ALKF23C*	AMKF22
Align Pedestals (for New Pedestals see above)	X	X	101E-225E	ALKF23C*	AMKF22
Align Personal Tower and Files (for New Towers see above)	X	X	101E-225E	ALKF23C*	AMKF22
Align Storage/Combination Files	X	X	101E-225E	ALKF23C*	AMKF22
Center Drawer (CSDC19/25)	X	X	101E-225E	ALKF23C	AMKF22
Classic Laterals	X	X	101E-225E	ALKF23C	AMKF22
Essentials™ Hutches	X	X	101E-225E	ALKF23C	AMKF22
Essentials Laterals	X	X	101E-225E	ALKF23C	AMKF22
Essentials Pedestals	X	X	101E-225E	ALKF23C	AMKF22
Essentials Personal Tower and Files	X	X	101E-225E	ALKF23C	AMKF22
Overheads (Flipper Door, including RTA)	X	X	101E-225E	ALKF23C	AMKF22
Overheads (Receding Door)	X	X	101E-225E	ALKF23C	AMKF22
Painted Wood Storage	X	X	101E-225E	ALKF23C	AMKF22
Persona Combination Files	X	X	101E-225E	ALKF23C	AMKF22
Persona Hoteling Laterals	X	X	101E-225E	ALKF23C	AMKF22
Persona Hutches	X	X	101E-225E	ALKF23C	AMKF22
Persona Laterals (including Custom)	X	X	101E-225E	ALKF23C	AMKF22
Persona Overfile Cabinets	X	X	101E-225E	ALKF23C	AMKF22
Persona Pedestals	X	X	101E-225E	ALKF23C	AMKF22
Persona Radius Overheads	X	X	101E-225E	ALKF23C	AMKF22
Persona Storage/Combination Cabinets	X	X	101E-225E	ALKF23C	AMKF22
Vertical Files A990/A940	X		101E-225E	ALKF23C	AMKF22

*ALKF23C is chrome. Optional black core for wood casegoods is ALKF23CE4. Optional matte silver core is ALKF26EL.

	Description	Model	List Price
	Removable Lock Core Kits	Key Numbers 101E-225E	
	Brushed Chrome used on metal and painted wood casegoods product produced after 2/3/97; A980, A990, and A940 Series vertical files; Persona™ pedestals produced after 8/22/09; Reach® Storage units produced after 10/5/09; and receding door overheads produced after 8/1/10. Includes one core, two keys, one core removal tool, adapter and instructions	ALKF23C 	\$ 18
	Black used on veneer casegoods product. Includes one core, two keys, one core removal tool, adapter and instructions. Core matches manufactured lock on metal casegoods but Black core can be used with veneer and laminate product.	ALKF23CE4 	\$ 18
	Matte Silver used on Align metal credenzas, new pedestals, and new towers. Includes one core, two keys, one core removal tool, adapter, and instructions.	ALKF26EL 	\$ 18
	Master Key (One key) Available to authorized dealers only on faxed orders. Will open ALKF23C, LKF23C, ALKF23CE4, LKF23CE4, LKF24, LKF25EL, and LKF25E4 locks numbered 101E-225E.	AMKF22 	\$ 17
HOW TO ORDER: Note: Numbers 101E-225E are available. Orders without numbers specified will be keyed at random. SAMPLE ORDER:			
	Quantity	Model	Color
	6	ALKF23C	X121E
	1	AMKF22	X
 	Brushed Chrome Removable Lock Core Kit*	Key Numbers 101N-225N	
	Includes one core, two keys, one core removal tool, adapter, and instructions	ALKF23CN 	\$ 18
	Master Key* (One key) Available to authorized dealers only on electronic orders. Will open ALKF23CN and LKF23CN locks numbered 101N-225N.	AMF22 	\$ 17

*On existing Premium and Asset lateral, use N-Series locks.

 Shippable by small-package carrier.

EASY LOCK PROGRAM

The Allsteel Easy Lock Program simplifies the lock-core ordering process when multiple cores are being specified. The Easy Lock cores can be used with Allsteel storage that currently uses the **ALKF23C** cores (all storage except receding door overheads).

To ensure ease of ordering in different situations the Easy Lock cores can be specified in three different ways — random, specified or sequential.

Random Keying

The random keying option is provided for instances where there are multiple orders or phases to a project and the offices need to be keyed alike but the key numbering is not required. With the random keying option key numbers are not specified, however, the core kits will be in sequential order from a random starting point.

Example: There are 15 offices which each have 5 black locks that need to be keyed alike, but the actual key numbers are not important.

This order would look like: **LKFE5BLK.X.15**

This specifies that 15 5-core kits are needed in black with random key numbers.

Specified Keying

The Specified Keying option is provided for the instances where there is a specific key number desired for all of the cores ordered.

Example: There are 10 offices which each have 2 silver locks that need to be keyed-alike with key number 202.

This order would look like: **LKFE2SLV.X202.10**

This specifies that 10 2-core kits are needed in silver with key number 202.

Sequential Keying

Allsteel Sequential Keying option is provided for the instances when there are multiple orders or phases to a project and it is imperative that key numbers are not duplicated.

Example: A multiple phase project has 60 total offices — 40 offices in Phase I, and 20 offices in Phase II. The project manager has expressed a need to have keyed-alike offices but doesn't want any of the offices to use the same key numbers.

The first 40 offices have 4 silver locks each that need to be keyed-alike.

This order would look like: **LKFE4SLV.SEQ/101.40**

This specifies that 40 4-core kits are needed in silver and the starting number is 101.

The second set of 20 offices only have 3 silver locks each that need to be keyed-alike; and it is important which key number starts off the sequence to ensure that no key number is duplicated. It is known that the first key range was key numbers 101-140.

The second order would look like: **LKFE3SLV.SEQ/141.20**

This specifies that 20 3-core kits are needed in silver and key sequence has to start at key number 141.

HOW TO ORDER:

Numbers 101-225 are available. Orders without key numbers specified will be keyed at random.

SAMPLE ORDER FOR EXAMPLES GIVEN:

Model	Key Type	Quantity
LKFE5BLK.	X.	15
LKFE2SLV.	X202.	10
LKFE4SLV.	SEQ/101.	40
LKFE3SLV.	SEQ/141.	20

Note: Quantity required is last number in model.option string.

Description	Model / Color	List Price
Easy Lock Lock-Core		
Lock Core Kit — 1 core, 2 keys	LKFE1 _____	\$ 18
Lock Core Kit — 2 cores, 2 keys	LKFE2 _____	\$ 36
Lock Core Kit — 3 cores, 2 keys	LKFE3 _____	\$ 54
Lock Core Kit — 4 cores, 2 keys	LKFE4 _____	\$ 72
Lock Core Kit — 5 cores, 2 keys	LKFE5 _____	\$ 90
Lock Core Kit — 6 cores, 2 keys	LKFE6 _____	\$ 108
Lock Core Kit — 7 cores, 2 keys	LKFE7 _____	\$ 126
Lock Core Kit — 8 cores, 2 keys	LKFE8 _____	\$ 144
Add color suffix to model: SLV Silver, BLK Black, MTS Matte Silver		
Note: One core removal key minimum per order. One additional core removal key per 25 lock-cores will be shipped.		
Master Key		
(One key) Available to authorized dealers only on faxed orders.		
	AMKF22	\$ 17

How to specify using Easy Lock Program:

Step 1 — Count the number of lock cores and color required in each workstation that need to be keyed alike.

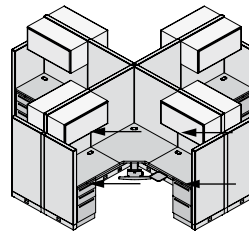

2 overheads with 1 lock-core each = 2
 2 pedestals with 1 lock-core each = 2
Total silver lock-cores per station = 4

Step 2 — Count the total number of workstations needing 4 lock-cores.

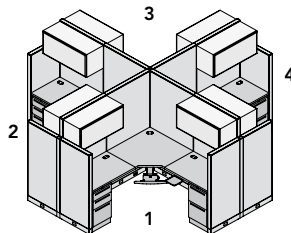

4 total workstations

Step 3 — Specify model number based on total number of lock-cores in a station and quantity of kits based on number of workstations.

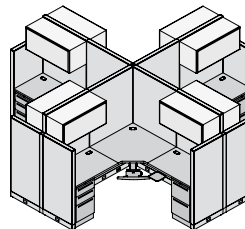

LKFE4SLV.X.4
 Lock-Cores per station
 Color of Core
 Number of workstations

Appendix

16x20 Sample Yardage and Touch-Up Paint

Open Market / GSA SIN 711-1 (as noted)

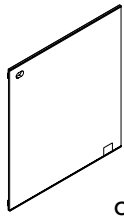

Open Market

Model	List Price by Grade							
	1	2	3	4	5	6		
Seating Upholstery Sample — 16"H x 20"W								
SYSTG [S]	\$ 113	\$ 126	\$ 134	\$ 141	\$ 154	N/A		
	7	8	9	10	Leather 1	Leather 2	11	12
	\$ 170	\$ 181	\$ 190	\$ 199	\$ 228	N/A	N/A	\$ 220

• Samples have sewn edges, a grommet, and label.

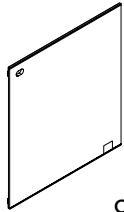

Open Market

Model	List Price by Grade					
	A	B	C	D	E	F
Systems Fabric Sample — 16"H x 20"W						
SYSFS [S]	\$ 91	\$ 98	\$ 103	\$ 113	N/A	N/A

• Samples have sewn edges, a grommet, and label.

How to specify —
Select the Model Number from above.

1st Option:
Fabric
(applicable only to individual samples):
See inside back cover for fabrics.

S | Y | | | | | | | | | | .

| | | | | | | | | |

Examples: SYSFS.PNL06 SYSTG.SWG904

	Description	Model	Core Paint P1 List Price	Select Paint P2 List Price
GSA SIN 711-1	Touch-Up Paint — Brush Bottle of Touch-Up Paint with Brush — 0.5 oz.	APTK [S]	\$ 60	\$ 67
GSA SIN 711-1	Touch-Up Paint — Spray Spray Can of Touch-Up Paint — 12 oz.	ARSLCC [S]	\$ 60	\$ 67

Core Paint Colors	Code	Select Paint Colors	Code
Black	P27	Brilliant White.....	PQ8
Brownstone	P7D	Carbon Metallic (<i>Spray Only</i>).....	P4Q
Bungalow	P7C	Champagne Metallic	PR5
Carob	P52	Gunmetal Metallic	PR3
Flint	P02	Platinum Metallic.....	PR2
Fossil	P28	Silver	PR6
Loft	P7B	Tungsten	PR1
Muslin.....	P4J		
Parchment	P93		

How to specify —
Select the Model Number from above.

1st Option:
Paint Color:
[C] [S]
See available Touch-Up Paint colors listed above. Some colors are limited to brush or spray.

A | | | | | | | | | | .

| | | | | | | | | |

Examples: APTK.P01 ARSLCC.P01

[S] Shippable by small-package carrier.

Replacement Parts Order Form

Please complete all banks for each appropriate section. Asterisk (*) is required information.

Date*		Mark for		Replacement PO #*	
Dealer Account #* (CC#)		Ship to Name*		Installation Date	
Dealer Name*		Ship to Address*		Requested Delivery Date	
Contact Name*		Ship to Address		Ship Method	
Contact Phone Number*		City, State, Zip*		Traffic Phone Number*	
Contact Email		Traffic Name*			
Contact FAX #					

Ordering Hints				Reason for Replacement <i>(apply appropriate reason number to each line)</i>			
<p>Add-ons/Mis-specified product — order as cataloged items on Synergy or your ordering system. <i>Do not use this form.</i></p> <p>Replacement parts order must be faxed or emailed to Allsteel Customer Support.</p> <p>Please alert CS of any special expedite requirements. Fees may apply.</p> <p>Replacement parts orders are usually shipped within 5 days.</p> <p>Punchlist and/or parts orders for projects should be sent to the Allsteel Project Coordinator assigned to the project.</p>				1	Shortage	*Shipping order number required below. Always billable with credit pending POD. Must be reported within 30 days of delivery.	
				2	Freight Damage	*Please provide serial number. Must be reported within 30 days of delivery date if shipping to a warehouse or 15 days if shipping direct to site.	
				3	Non-conforming Product	*Please provide serial number.	
				4	Billable	Purchase order number is required. Replacement parts are net priced (no discounting). *Freight will be invoiced if order is billable. Order finished goods (cataloged items) electronically on Synergy or your operating system.	
Qty	Serial Number	Model Number (complete with options)	Part Number (if known)	Description of Part Needed	Original Shipping Order #	Reason #	Description of Damage/Problem

Note: This form is also available on the Allsteel Synergy website.

Call Center Team – Email: ASITeamCS@AllsteelOffice.com
 Aligned Team – Email: CSAlignedTeam@AllsteelOffice.com
 National Team – Email: ASINATLTeam@AllsteelOffice.com

LOCKS
EASY LOCK
SAMPLES & PAINT
PARTS
HIGHER GRADES
INDEX
UPHOLSTERIES
PANEL FABRICS

Appendix

Fabric Grade Pricing

Model Number	Grade 13	Grade 14	Grade 15	Grade 16	Grade 17	Grade 18	Grade 19	Grade 20	Grade 21	Grade 22
Align™ and Essentials™ Pedestal Seat Cushion Tops — see page 73										
ASPT-24SC 23½"D	\$ 397	\$ 428	\$ 459	\$ 490	\$ 521	\$ 551	\$ 582	\$ 613	\$ 644	\$ 675
ASPT-24SCFC 23½"D	\$ 472	\$ 500	\$ 529	\$ 558	\$ 587	\$ 615	\$ 644	\$ 673	\$ 701	\$ 730
ASPT-30SC 29½"D	\$ 345	\$ 367	\$ 390	\$ 413	\$ 436	\$ 459	\$ 481	\$ 504	\$ 527	\$ 550
ASPT-30SCFC 29½"D	\$ 536	\$ 564	\$ 593	\$ 622	\$ 651	\$ 679	\$ 708	\$ 737	\$ 765	\$ 794

Model Number	Grade 9	Grade 10	Grade 11	Grade 12	Grade 13	Grade 14	Grade 15	Grade 16	Grade 17	Grade 18	Grade 19	Grade 20	Grade 21	Grade 22
Involve® Ped/Credenza Cushions – 18"D — see page 124														
K5CT1815SC	\$ 362	\$ 383	\$ 403	\$ 440	\$ 477	\$ 514	\$ 551	\$ 588	\$ 625	\$ 662	\$ 699	\$ 736	\$ 772	\$ 809
K5CT1818SC	\$ 387	\$ 406	\$ 428	\$ 467	\$ 506	\$ 545	\$ 583	\$ 622	\$ 661	\$ 700	\$ 739	\$ 778	\$ 817	\$ 856
K5CT1824SC	\$ 417	\$ 438	\$ 461	\$ 503	\$ 545	\$ 587	\$ 629	\$ 671	\$ 713	\$ 755	\$ 797	\$ 839	\$ 881	\$ 923
K5CT1830SC	\$ 447	\$ 471	\$ 496	\$ 541	\$ 586	\$ 631	\$ 676	\$ 721	\$ 766	\$ 811	\$ 856	\$ 901	\$ 947	\$ 992
K5CT1836SC	\$ 494	\$ 519	\$ 547	\$ 595	\$ 643	\$ 692	\$ 740	\$ 788	\$ 836	\$ 884	\$ 932	\$ 981	\$ 1029	\$ 1077
K5CT1848SC	\$ 524	\$ 549	\$ 579	\$ 631	\$ 683	\$ 735	\$ 788	\$ 840	\$ 892	\$ 944	\$ 997	\$ 1049	\$ 1101	\$ 1154

Involve Ped/Credenza Cushions – 24"D — see page 124														
K5CT2415SC	\$ 378	\$ 399	\$ 420	\$ 458	\$ 495	\$ 533	\$ 571	\$ 609	\$ 647	\$ 685	\$ 723	\$ 761	\$ 799	\$ 837
K5CT2418SC	\$ 401	\$ 419	\$ 442	\$ 482	\$ 522	\$ 562	\$ 602	\$ 642	\$ 682	\$ 722	\$ 762	\$ 802	\$ 842	\$ 882
K5CT2424SC	\$ 432	\$ 454	\$ 479	\$ 522	\$ 565	\$ 608	\$ 652	\$ 695	\$ 738	\$ 781	\$ 824	\$ 867	\$ 910	\$ 953
K5CT2430SC	\$ 466	\$ 490	\$ 516	\$ 563	\$ 610	\$ 657	\$ 704	\$ 752	\$ 799	\$ 846	\$ 893	\$ 940	\$ 987	\$ 1034
K5CT2436SC	\$ 503	\$ 529	\$ 556	\$ 608	\$ 659	\$ 710	\$ 761	\$ 813	\$ 864	\$ 915	\$ 966	\$ 1018	\$ 1069	\$ 1120
K5CT2448SC	\$ 541	\$ 570	\$ 601	\$ 655	\$ 709	\$ 764	\$ 818	\$ 872	\$ 927	\$ 981	\$ 1035	\$ 1090	\$ 1144	\$ 1198

Involve Banquette Cushions – 24"D — see page 129														
KSC2424	\$ 1171	\$ 1216	\$ 1262	\$ 1318	\$ 1375	\$ 1431	\$ 1487	\$ 1544	\$ 1600	\$ 1657	\$ 1713	\$ 1769	\$ 1826	\$ 1882
KSC2424FC	\$ 1289	\$ 1334	\$ 1380	\$ 1436	\$ 1493	\$ 1549	\$ 1605	\$ 1662	\$ 1718	\$ 1775	\$ 1831	\$ 1887	\$ 1944	\$ 2000
KSC3624	\$ 1505	\$ 1562	\$ 1621	\$ 1694	\$ 1766	\$ 1839	\$ 1912	\$ 1985	\$ 2058	\$ 2130	\$ 2203	\$ 2276	\$ 2349	\$ 2421
KSC3624FC	\$ 1624	\$ 1681	\$ 1740	\$ 1813	\$ 1885	\$ 1958	\$ 2031	\$ 2104	\$ 2177	\$ 2249	\$ 2322	\$ 2395	\$ 2468	\$ 2540

Involve Seat Base Cushions – 24"D — see page 129														
KSSC2424	\$ 587	\$ 607	\$ 629	\$ 657	\$ 686	\$ 715	\$ 743	\$ 772	\$ 801	\$ 830	\$ 858	\$ 887	\$ 916	\$ 944
KSSC2424FC	\$ 646	\$ 666	\$ 688	\$ 716	\$ 745	\$ 774	\$ 802	\$ 831	\$ 860	\$ 889	\$ 917	\$ 946	\$ 975	\$ 1003

Cross Reference Index

by Model Number

Model	Page	Model	Page	Model	Page	Model	Page	Model	Page	Model	Page
K2TP176024AF	117	K2TPST572418LFF	132	K2TTS71224R	130	K6DM2830L	148	K6TB2660T	151	KL283624E	120
K2TP176024RAF	117	K2TPST572418RBBF	132	K2TTS71824LFF	132	K6DM2834L	148	K6TB2672T	151	KL283624FF	120
K2TP177218AF	117	K2TPST572418RFF	132	K2TTS71824RBBF	132	K6DM2835L	148	K6TB2672T	151	KL283618N	121
K2TP177218RAF	117	K2TPST572424LBBF	132	K2TTS71824LBBF	132	K6DM2836L	148	K6TB26841T	151	KL284818N	121
K2TP177224AF	117	K2TPST572424LFF	132	K2TTS72424LFF	148	K6DM2840L	148	K6TB26841T	151	KL284824N	121
K2TP177224RAF	117	K2TPST572424RBBF	132	K2TTS72424RBBF	148	K6DM2841L	148	K6TB26841T	151	KL423618FFF	122
K2TP241818A	119	K2TPST572424RFF	132	K2TTS72424RFF	148	K6DM2842L	148	K6TB26842T	151	KL1812424A	128
K2TP241818BFF	119	K2TPT421218L	130	K2TT651218L	130	K6DM2843L	148	K6TB26961T	151	KL1812424A	128
K2TP241818BFF	119	K2TPT421218R	130	K2TT651218R	130	K6DM2844L	148	K6TB26962T	151	KL1813624A	128
K2TP241824AF	119	K2TPT421224L	130	K2TT651224L	130	K6DM2847L	148	K6TB26962T	151	KL1813624A	128
K2TP241824BFF	119	K2TPT421224R	130	K2TT651224R	130	K6DM2849L	148	K6TB2730T	151	KL1814824A	128
K2TP242418A	119	K2TPT501218L	130	K2TT651824L	133	K6DM2853L	148	K6TB2736T	151	KL1814824A	128
K2TP242418A	119	K2TPT501218R	130	K2TT651824LBBF	133	K6DM2855L	148	K6TB2742T	151	KLBC653015A	123
K2TP243018BFF	119	K2TPT501224L	130	K2TT651824LFF	133	K6DM2858L	148	K6TB2748T	151	KLBC653024F	123
K2TP243024A	119	K2TPT501224R	130	K2TT651824R	133	K6DM2859L	148	K6TB2760T	151	KLBC653615A	123
K2TP243024BFF	118	K2TPT501824LBBF	131	K2TT651824RBBF	133	K6DM2861L	148	K6TB2772T	151	KLBC723015A	123
K2TP243618A	119	K2TPT501824LFF	131	K2TT651824RFF	133	K6DM2864L	148	K6TB2772T	151	KLBC723024F	123
K2TP243618BFF	118	K2TPT501824RBBF	131	K2TT652424L	133	K6DM2870L	148	K6TB2772T	151	KLBC723615A	123
K2TP243618R	119	K2TPT501824RFF	131	K2TT652424LBBF	133	K6DM2876L	148	K6TB27841T	151	KLBC723624F	123
K2TP243624A	119	K2TPT502424LBBF	131	K2TT652424LFF	133	K6DM2877L	148	K6TB27842T	151	KLBP1530	139
K2TP243624B	118	K2TPT502424LFF	131	K2TT652424R	133	K6DM2877L	148	K6TB27842T	151	KLBP1536	139
K2TP243624A	119	K2TPT502424RBBF	131	K2TT652424RBBF	133	K6DM2877L	148	K6TB27961T	151	KLBP1548	139
K2TP243624B	118	K2TPT502424RFF	131	K2TT652424RFF	133	K6DM2881L	149	K6TB27962T	151	KLBP1560	139
K2TP244818AF	119	K2TPT571218L	130	K2TT721824L	134	K6DM2881L	149	K6TB2796T	151	KLBP1572	139
K2TP244818RAF	118	K2TPT571218R	130	K2TT721824LBBF	134	K6DM2882L	149	K6TB2796T	151	KLBP1584	139
K2TP244824AF	118	K2TPT571224L	130	K2TT721824LFF	134	K6DM2883L	149	K6TB3548T	141	KLBP1596	139
K2TP244824B	118	K2TPT571224R	130	K2TT721824R	134	K6DM2883L	149	K6TB3548T	141	KLBC153618S	137
K2TP244824RAF	118	K2TPT571824LBBF	132	K2TT721824RBBF	134	K6DM2884L	149	K6TB3584T	141	KLBC154818S	137
K2TP244618AF	118	K2TPT571824LFF	132	K2TT722424L	134	K6DM2884L	149	K6TB4248T	141	KLBC156018S	137
K2TP244618RAF	118	K2TPT571824RBBF	132	K2TT722424LBBF	134	K6DM2884L	149	K6TB4260T	141	KLBC201818L	135
K2TP246024AF	118	K2TPT571824RFF	132	K2TT722424LFF	134	K6DM2884L	149	K6TB4260T	141	KLBC201818L	135
K2TP247218AF	118	K2TPT572424LBBF	132	K2TT722424R	134	K6DM2884L	149	K6TB4260T	141	KLBC201818L	135
K2TP247218RAF	118	K2TPT572424LFF	132	K2TT722424RBBF	134	K6DM2884L	149	K6TB4272T	141	KLBC201818L	135
K2TP247218BFF	118	K2TPT572424LFF	132	K2TT722424RFF	134	K6DM2884L	149	K6TB4272T	141	KLBC202418A	135
K2TP247218BFF	118	K2TPT572424RBBF	132	K2TT722424RFF	134	K6DM2884L	149	K6TB4284T	141	KLBC202418A	135
K2TP247224AF	118	K2TPT572424RFF	132	K530603GEZ	142	K6DM2884L	149	K6T8K	138	KLBC202418A	135
K2TP247224BFF	118	K2TPT651218L	130	K530723GEZ	142	K6DM2884L	149	K6TR18	134, 157	KLBC202418A	135
K2TP281518BFF	116	K2TPT651218R	130	K530783GEZ	142	K6DM2884L	149	KL13618A	128	KLBC202418A	135
K2TP281518BFF	116	K2TPT651224L	130	K530783GEZ	142	K6DM2884L	149	KL13624A	128	KLBC202418A	135
K2TP281524BFF	116	K2TPT651224R	130	K530783GEZ	142	K6DM2884L	149	KL14818A	128	KLBC202418A	135
K2TP281524BFF	116	K2TPT651224R	130	K530783GEZ	142	K6DM2884L	149	KL14824A	128	KLBC202418A	135
K2TP281530BFF	116	K2TPT651824L	133	K530783GEZ	142	K6DM2884L	149	KL14824A	128	KLBC202418A	135
K2TP281530BFF	116	K2TPT651824L	133	K530783GEZ	142	K6DM2884L	149	KL172424C	117, 128	KLBC202418A	135
K2TP281530FF	116	K2TPT651824L	133	K530783GEZ	142	K6DM2884L	149	KL174818AF	117	KLBC202418A	135
K2TP281818A	116	K2TPT651824LBBF	133	K530783GEZ	142	K6DM2884L	149	KL174818RAF	117	KLBC202418A	135
K2TP281818BFF	116	K2TPT651824LFF	133	K530783GEZ	142	K6DM2884L	149	KL174824RAF	117	KLBC202418A	135
K2TP281818BFF	116	K2TPT651824R	133	K530783GEZ	142	K6DM2884L	149	KL176018AF	117	KLBC202418A	135
K2TP281824A	116	K2TPT651824RBBF	133	K530783GEZ	142	K6DM2884L	149	KL176018RAF	117	KLBC202418A	135
K2TP281824BFF	116	K2TPT651824RFF	133	K530783GEZ	142	K6DM2884L	149	KL176018RAF	117	KLBC202418A	135
K2TP281824FF	116	K2TPT652424LBBF	133	K530783GEZ	142	K6DM2884L	149	KL176018RAF	117	KLBC202418A	135
K2TP281830BFF	116	K2TPT652424LFF	133	K530783GEZ	142	K6DM2884L	149	KL176024AF	117	KLBC202418A	135
K2TP281830FF	116	K2TPT652424R	133	K530783GEZ	142	K6DM2884L	149	KL176024RAF	117	KLBC202418A	135
K2TP282418A	121	K2TPT652424RBBF	133	K530783GEZ	142	K6DM2884L	149	KL177218AF	117	KLBC202418A	135
K2TP282418BFF	120	K2TPT652424RFF	133	K530783GEZ	142	K6DM2884L	149	KL177218RAF	117	KLBC202418A	135
K2TP282424A	120	K2TPT71824L	134	K530783GEZ	142	K6DM2884L	149	KL177224AF	117	KLBC202418A	135
K2TP282424BFF	120	K2TPT71824LBBF	134	K530783GEZ	142	K6DM2884L	149	KL177224RAF	117	KLBC202418A	135
K2TP283018A	121	K2TPT71824LFF	134	K530783GEZ	142	K6DM2884L	149	KL241518MBF	116	KLBC202418A	135
K2TP283018BFF	120	K2TPT71824R	134	K530783GEZ	142	K6DM2884L	149	KL241818A	119	KLBC202418A	135
K2TP283018BFF	120	K2TPT71824RBBF	134	K530783GEZ	142	K6DM2884L	149	KL241818BFF	116	KLBC202418A	135
K2TP283024A	121	K2TPT722424L	134	K530783GEZ	142	K6DM2884L	149	KL241824A	119	KLBC202418A	135
K2TP283024BFF	120	K2TPT722424LBBF	134	K530783GEZ	142	K6DM2884L	149	KL241824BFF	116	KLBC202418A	135
K2TP283024FF	120	K2TPT722424LFF	134	K530783GEZ	142	K6DM2884L	149	KL242418A	119	KLBC202418A	135
K2TP283618A	121	K2TPT722424R	134	K530783GEZ	142	K6DM2884L	149	KL242424A	119	KLBC202418A	135
K2TP283618B	120	K2TPT722424RBBF	134	K530783GEZ	142	K6DM2884L	149	KL243018A	119	KLBC202418A	135
K2TP283618N	120	K2TPT722424RFF	134	K530783GEZ	142	K6DM2884L	149	KL243018BFF	119	KLBC202418A	135
K2TP283618R	121	K2TST501818LBBF	131	K530783GEZ	142	K6DM2884L	149	KL243024A	119	KLBC202418A	135
K2TP283624A	121	K2TST501818LFF	131	K530783GEZ	142	K6DM2884L	149	KL243024BFF	118	KLBC202418A	135
K2TP283624B	120	K2TST501818RBBF	131	K530783GEZ	142	K6DM2884L	149	KL243618A	119	KLBC202418A	135
K2TP283624FF	120	K2TST501818RFF	131	K530783GEZ	142	K6DM2884L	149	KL243618BFF	119	KLBC202418A	135
K2TP283624N	121	K2TST501824LBBF	131	K530783GEZ	142	K6DM2884L	149	KL243618R	119	KLBC202418A	135
K2TP284818N	121	K2TST501824LFF	131	K530783GEZ	142	K6DM2884L	149	KL243618R	119	KLBC202418A	135
K2TP284824N	121	K2TST501824RBBF	131	K530783GEZ	142	K6DM2884L	149	KL243624A	118	KLBC202418A	135
K2TP284824N	121	K2TST501824RFF	131	K530783GEZ	142	K6DM2884L	149	KL243624B	118	KLBC202418A	135
K2TP423618FFF	122	K2TST501824R	131	K530783GEZ	142	K6DM2884L	149	KL243624N	119	KLBC202418A	135
K2TP46024RAF	118	K2TST502418LBBF	131	K530783GEZ	142	K6DM2884L	149	KL243624N	119	KLBC202418A	135
K2TPB112424A	128	K2TST502418LFF	131	K530783GEZ	142	K6DM2884L	149	KL244818AF	118	KLBC202418A	135
K2TPB112424AF	128	K2TST502418RBBF	131	K530783GEZ	142	K6DM2884L	149	KL244818AF	118	KLBC202418A	135
K2TPB113624A	128	K2TST502418RFF	131	K530783GEZ	142	K6DM2884L	149	KL244818RAF	118	KLBC202418A	135
K2TPB113624B	128	K2TST502424LBBF	131	K530783GEZ	142	K6DM2884L	149	KL244824AF	118	KLBC202418A	135
K2TPB114824A	128	K2TST502424LFF	131	K530783GEZ	142	K6DM2884L	149	KL244824AF	118	KLBC202418A	135
K2TPB114824B	128	K2TST502424RBBF	131	K530783GEZ	142	K6DM2884L	149	KL244824RAF	118	KLBC202418A	135
K2TPB653015A	123	K2TST502424RFF	131</								

Cross Reference Index

by Model Number

Model	Page	Model	Page	Model	Page	Model	Page	Model	Page	Model	Page
KLECB2836	154	KLPT244824RAF	118	KLPT501824RBBF	131	KLPT651824LFF	133	PF197-203I	71	TAWG	157
KLECB2848	154	KLPT246018LAF	118	KLPT501824RFF	131	KLPT651824R	133	PF197-233	71	TV51848S	144
KLF173018	117	KLPT246018RAF	118	KLPT502424LBBF	131	KLPT651824RBBF	133	PF197-233A	71	TV51854S	144
KLF173024	117	KLPT246024LAF	118	KLPT502424LFF	131	KLPT651824RFF	133	PF197-233B	71	TV51860S	144
KLF173618	117	KLPT247218LAF	118	KLPT502424RBBF	131	KLPT652424L	133	PF197-233I	71	TV51872S	144
KLF173624	117	KLPT247218RAF	118	KLPT502424RFF	131	KLPT652424LBBF	133	PF197-303	71	UW7DA	125
KLGF	125	KLPT247224LAF	118	KLPT502424RFF	131	KLPT652424LFF	133	PF197-303A	71	WBD	179
KLH3548A	140	KLPT247224RAF	118	KLPT571218R	130	KLPT652424R	133	PF197-303B	71	WLR	179
KLH3548H	140	KLPT247224RRAF	118	KLPT571222L	130	KLPT652424RBBF	133	PF197-303I	71	WPR	179
KLH3548N	140	KLPT281518BFF	116	KLPT571224R	130	KLPT652424RFF	133	PF198-182A	71	WTR	179
KLH3560A	140	KLPT281524BFF	116	KLPT571824LBBF	132	KLPT721824L	134	PF198-182B	71	YPB29VW	168
KLH3560H	140	KLPT281524LFF	116	KLPT571824LFF	132	KLPT721824LBBF	134	PF198-182I	71	YPCABD02	42
KLH3560N	140	KLPT281530BFF	116	KLPT571824RBBF	132	KLPT721824LFF	134	PF198-182S	71	YPCABD10	42
KLH3566A	140	KLPT281530LFF	116	KLPT571824RFF	132	KLPT721824R	134	PF198-202A	71	YPCACW35	42
KLH3566H	140	KLPT281818A	116	KLPT572424LBBF	132	KLPT721824RBBF	134	PF198-202A	71	YPCACW35	42
KLH3566N	140	KLPT281818FF	116	KLPT572424LFF	132	KLPT721824RFF	134	PF198-202B	71	YPCACW50	42
KLH3572A	140	KLPT281824A	116	KLPT572424RBBF	132	KLPT722424L	134	PF198-202I	71	YPCACW65	42
KLH3572H	140	KLPT281824BBF	116	KLPT651218L	130	KLPT722424LBBF	134	PF198-232	71	YPCAFD02	42
KLH3572N	140	KLPT281824FF	116	KLPT651218R	130	KLPT722424LFF	134	PF198-232A	71	YPCAFD10	42
KLH3584A	140	KLPT281830BFF	116	KLPT651222L	130	KLPT722424R	134	PF198-232B	71	YPCAHR12	42
KLH3584H	140	KLPT281830FF	116	KLPT651224R	130	KLPT722424RBBF	134	PF198-232I	71	YPCAHR12	42
KLH3584N	140	KLPT282418A	121	KLPT651224R	130	KLPT722424RFF	134	PF198-302	71	YPCBK222418BFFMA	38
KLH4248A	140	KLPT282418BFF	120	KLPT651824L	133	KLPT722424RFF	134	PF198-302A	71	YPCBK222418BFFMB	38
KLH4248H	140	KLPT282424A	120	KLPT651824LBBF	133	KLTT111224	128	PF198-302B	71	YPCBK222418BFFMH	38
KLH4248N	140	KLPT282424BFF	120	KLPT651824LFF	133	KLTT112242	128	PF198-302I	71	YPCBK222418BFFMI	38
KLH4260A	140	KLPT283018A	121	KLPT651824R	133	KLTT112424P	128	PH149-182A	71	YPCBK222418BFFMS	38
KLH4260H	140	KLPT283018BFF	120	KLPT651824RBBF	133	KLTT113624	128	PH149-182B	71	YPCBK222418B	38
KLH4260N	140	KLPT283018FF	120	KLPT651824RFF	133	KLTT114824	128	PH149-182I	71	YPCBK222424BFFMA	38
KLH4266A	140	KLPT283024A	121	KLPT652424L	133	SPS1812	127	PH149-182S	71	YPCBK222424BFFMB	38
KLH4266H	140	KLPT283024BFF	120	KLPT652424LBBF	133	SPS1818	127	PH149-202	71	YPCBK222424BFFMH	38
KLH4266N	140	KLPT283024FF	120	KLPT652424LFF	133	SPS2124	127	PH149-202A	71	YPCBK222424BFFMI	38
KLH4272A	140	KLPT283618A	121	KLPT652424R	133	SPS2412	127	PH149-202B	71	YPCBK222424BFFMS	38
KLH4272H	140	KLPT283618B	120	KLPT652424RBBF	133	SPS2418	127	PH149-202I	71	YPCBK223018BFFMA	38
KLH4272N	140	KLPT283618FF	120	KLPT652424RFF	133	SPS2422	127	PH149-232A	71	YPCBK223018BFFMB	38
KLH4284A	140	KLPT283618N	121	KLPT721824L	134	SPS2424	127	PH149-232B	71	YPCBK223018BFFMH	38
KLH4284H	140	KLPT283624A	120	KLPT721824LBBF	134	SPS3018	127	PH149-232I	71	YPCBK223018BFFMI	38
KLH4284N	140	KLPT283624B	120	KLPT721824LFF	134	SPS3024	127	PH119-232	71	YPCBK223024BFFMA	38
KLOC07241SSH	137	KLPT283624FF	120	KLPT721824R	134	SPS3612	127	PH119-232A	71	YPCBK223024BFFMB	38
KLOC07301SSH	137	KLPT283624N	121	KLPT721824RBBF	134	SPS3618	127	PH119-232B	71	YPCBK223024BFFMH	38
KLOC07361SSH	137	KLPT284818N	121	KLPT722424L	134	SPS3624	127	PH119-232I	71	YPCBK223024BFFMI	38
KLOC07421SSH	137	KLPT284824N	121	KLPT722424LBBF	134	KPSD2412	127	PH187-183A	71	YPCBK223024BFFMS	38
KLOC07481SSH	137	KLPT284824FF	121	KLPT722424LFF	134	KPSD2418	127	PH187-183B	71	YPCBK223024BFFMA	38
KLOC152415A	136	KLPT423618FF	118	KLPT722424R	134	KPSD2424	127	PH187-183I	71	YPCBK223024BFFMB	38
KLOC152415H	136	KLPT423618N	118	KLPT722424RBBF	134	KPSD3012	127	PH187-183S	71	YPCBK223024BFFMH	38
KLOC152415N	136	KLPT423618A	118	KLPT722424RFF	134	KPSD3018	127	PH187-183S	71	YPCBK223024BFFMI	38
KLOC153015A	136	KLPT424824A	128	KLPS45MK	137	KPSD3024	127	PH187-203	71	YPCBK223618BFFMA	38
KLOC153015H	136	KLPT424824H	128	KLSPMK	137	KPSD3612	127	PH187-203A	71	YPCBK223618BFFMB	38
KLOC153015N	136	KLPT424824N	128	KLSPMK	137	KPSD3618	127	PH187-203B	71	YPCBK223618BFFMH	38
KLOC153615A	136	KLPT424824FF	128	KLST501818LBBF	131	KPSD3624	127	PH187-203I	71	YPCBK223618BFFMI	38
KLOC153615H	136	KLPT424824N	128	KLST501818LFF	131	KRS30603GEZ	142	PH187-233	71	YPCBK223618BFFMS	38
KLOC153615N	136	KLPT424824A	128	KLST501818RBBF	131	KRS30783GEZ	142	PH187-233A	71	YPCBK223624BFFMA	38
KLOC154215A	136	KLPT423618A	121	KLST501818RFF	131	KS2410	137	PH187-233B	71	YPCBK223624BFFMB	38
KLOC154215H	136	KLPT423618B	120	KLST501824LBBF	131	KS3010	137	PH187-233I	71	YPCBK223624BFFMH	38
KLOC154215N	136	KLPT423618FF	120	KLST501824LFF	131	KS5010	137	PH187-303	71	YPCBK223624BFFMI	38
KLOC154815A	136	KLPT423618N	121	KLST501824RBBF	131	KS5210	137	PH187-303A	71	YPCBK223624BFFMS	38
KLOC154815H	136	KLPT423618A	121	KLST501824RFF	131	KS4810	137	PH187-303B	71	YPCBK223624BFFMA	38
KLOC154815N	136	KLPT423618B	120	KLST502418LBBF	131	KS4820	137	PH187-303I	71	YPCBK224218BFFMA	38
KLOC156015A	136	KLPT423618FF	120	KLST502418LFF	131	KS2424	129	PH188-182A	71	YPCBK224218BFFMB	38
KLOC156015H	136	KLPT423618N	121	KLST502418RBBF	131	KS2442FC	129	PH188-182B	71	YPCBK224218BFFMH	38
KLOC156015N	136	KLPT423618A	121	KLST502424LBBF	131	KS3624	129	PH188-182I	71	YPCBK224218BFFMI	38
KLOC157215A	136	KLPT423618B	120	KLST502424LFF	131	KS3642FC	129	PH188-182S	71	YPCBK224218BFFMS	38
KLOC157215H	136	KLPT423618FF	120	KLST502424RBBF	131	KS3642FC	129	PH188-202	71	YPCBK224218BFFMA	38
KLOC157215N	136	KLPT423618N	121	KLST502424RFF	131	KS5C2424	129	PH188-202A	71	YPCBK224218BFFMB	38
KLOC158415A	136	KLPT423618A	121	KLST502424RFF	131	KS5C2424FC	129	PH188-202B	71	YPCBK224218BFFMH	38
KLOC158415H	136	KLPT423618B	120	KLST571818LBBF	132	KVS30603GEZ	144	PH188-202I	71	YPCBK224218BFFMI	38
KLOC158415N	136	KLPT423618FF	120	KLST571818LFF	132	KVS30723GEZ	144	PH188-202S	71	YPCBK224218BFFMS	38
KLOC159615A	136	KLPT423618N	121	KLST571818RBBF	132	KVS307836EZ	144	PH188-232	71	YPCBK224218BFFMA	38
KLOC159615H	136	KLPT423618A	121	KLST571818RFF	132	KVM15	157	PH188-232A	71	YPCBK224218BFFMB	38
KLOC159615N	136	KLPT423618B	120	KLST571818RFF	132	KVM18	157	PH188-232B	71	YPCBK224218BFFMH	38
KLOC232415H	137	KLPT173018	117	KLST571824LBBF	132	KVM24	157	PH188-202I	71	YPCBK224218BFFMI	38
KLOC233015H	137	KLPT173024	117	KLST571824LFF	132	KVM30	157	PH188-302B	71	YPCBK224218BFFMS	38
KLOC233615H	137	KLPT173618	117	KLST571824RBBF	132	KVM36	157	PH188-302I	71	YPCBK224218BFFMA	38
KLOC234215H	137	KLPT173624	117	KLST571824RFF	132	KVM48	157	PH188-302S	71	YPCBK224218BFFMB	38
KLOC234815H	137	KLPTK	125	KLST571824RFF	132	KVM60	157	PT17-20TTP	73	YPCBK224218BFFMH	38
KLOC234815H	137	KLPT501818LBBF	131	KLST572418LBBF	132	KVM64	157	PT17-23TTP	73	YPCBK224218BFFMI	38
KLOC234815H	137	KLPT501818LFF	131	KLST572418LFF	132	KVM72	157	PT17-29TTP	73	YPCBK224218BFFMS	38
KLOC234815H	137	KLPT501818RBBF	131	KLST572424LBBF	132	KWM72	157	S91406GC	157	YPCBK224224BFFMA	38
KLOC236015H	137	KLPT501818RFF	131	KLST572424LFF	132	L919492	76	SH1218	130	YPCBK224224BFFMB	38
KLPT113618A	128	KLPT501824RBBF	131	KLST572424RBBF	132	L919703	76	SH1224	130	YPCBK224224BFFMH	38
KLPT113624A	128	KLPT501824RFF	131	KLST572424RFF	132	LFKFE	182	SH1818	126	YPCBK224224BFFMI	38
KLPT114818A	128	KLPT502418LBBF	131	KLST502418L	130	LFKFEAMTS	42	SH1824	126	YPCBK224224BFFMS	38
KLPT114824A	128	KLPT502418LFF	131	KLST502418RBBF	131	LFKFEAMTS	42	SH1824A	126	YPCBK224244BFFMA	38
KLPT172424C	117	KLPT502418RBBF	131	KLST502424LBBF	131	LFKFEAMTS	42	SH2418A	126	YPCBK224244BFFMB	38
KLPT174818LAF	117	KLPT502418RFF	131	KLST502424LFF	131	LFKFEAMTS	42	SH2424	126	YPCBK224244BFFMH	38
KLPT174818RAF	117	KLPT502418RBBF	131	KLST501218R	130	LFKFEAMTS	42	SH2424A	126	YPCBK224244BFFMI	38
KLPT174824LAF	117	KLPT502418RFF	131	KLST501218R	130	LFKFEAMTS	42	SH3015A	126	YPCBK224244BFFMS	38
KLPT174824RAF	117	KLPT502424LBBF	131	KLST501224R	130	LFKFEAMTS	42	SH3018A	126	YPCBK224818BFFMA	38
KLPT176018LAF	117	KLPT502424LFF	131	KLST501224R	130	LFKFEAMTS	42	SH3024A	126	YPCBK224818BFFMB	38
KLPT176018RAF	117	KLPT502424RBBF	131	KLST501824L	133	LFKFEAMTS	42	SH3618A	126	YPCBK224818BFFMH	38
KLPT176024LAF	117	KLPT502424RFF	131	KLST501824LBBF	133	LFKFEAMTS	42	SH3624A	126	YPCBK224818BFFMI	38
KLPT176024RAF	117	KLPT502424RFF	131	KLST501824LFF	133	LFKFEAMTS	42	SH4818A	126	YPCBK224818BFFMS	38
KLPT177218LAF	117	KLPT502424RFF	131								

Refer to page 194 for current upholstery availability by Involve model/series. Refer to Seating price list for Partnership fabric codes.

GRADE 1	GRADE 1 – continued	GRADE 1 – continued	GRADE 2 – continued	GRADE 2 – continued
ATTIRE	DAPPER	PERENNIAL B, C, F, O, S, T ^D	HOTSPOT	SPIN SEATING
Blaze AI42	(100% Polyester)	(100% Recycled)	(76% Post Consumer Recycled Polyester; 24% Cationic)	(51% Polyester, 49% Recycled Polyester)
Blue Lagoon AI90	Ash DAPR20	Bark PNL04	Blackberry HTS11	Alabaster SPNN02
Crimson AI62	Azalea DAPR95	Bellflower PNL13	Chai HTS05	Cavern SPNN03
Fatigue AI76	Breeze DAPR06	Daylily PNL06	Charcoal HTS03	Cobblestone SPNN04
Ivy AI82	Canvas DAPR25	Delphinium PNL05	Cloud HTS02	Ember SPNN06
Lithium AI19	Currant DAPR00	Fennel PNL07	Leaf HTS13	Flame SPNN07
Onyx AI10	Emerald DAPR75	Fuchsia PNL15	Lime HTS12	Heron SPNN13
Sable AI49	Fawn DAPR35	Helenium PNL17	Meteor HTS06	Oat SPNN01
Taupe AI26	Jewel DAPR08	Ivy PNL10	Mushroom HTS07	Ocean SPNN12
Turquoise AI96	Margold DAPR65	Lilium PNL14	Persimmon HTS09	Plum SPNN15
CENTURION B, C, O, S, T	Onyx DAPR10	Phlox PNL16	Pumice HTS04	Pool SPNN11
(Nanotex™ Stain-Resistant finish)	Orchid DAPR90	Primrose PNL12	Royal HTS15	Raven SPNN10
Apricot CU47	Peony DAPR50	Sage PNL03	Scarlet HTS10	Rhubarb SPNN14
Bark CU25	Pool DAPR05	Zinnia PNL09	Sky HTS14	Tropic SPNN08
Berry CU62	Rose DAPR40	GRADE 2	Sugar HTS01	Willow SPNN05
Black CU10	Sapphire DAPR07	APPOINT SEATING	Sunny HTS08	
Espresso CU49	Scarlet DAPR45	Blackberry PNS012	MOGULS C, O, S, T	TEMPO ^D
Frost CU22	Sepia DAPR30	Bronze PNS002	(100% Recycled)	(100% Recycled)
Goldenrod CU27	Slate DAPR15	Carbon PNS008	Birch MOG43	Azure TPO08
Iron NEW! CU50	Sorbet DAPR55	Cherry PNS010	Flare MOG88	Chestnut TPO01
Jade CU83	Spice DAPR60	Espresso PNS003	Grape Jelly MOG95	Onyx TPO04
Marsala CU63	Spring DAPR80	Framboise PNS011	Graphite MOG97	Sage TPO07
Morel CU09	Varsity DAPR09	Jet PNS007	Java MOG42	Topaz TPO05
Navy CU98	Zest DAPR70	Lawn PNS005	Mandarin MOG45	Vermillion TPO06
Olivine CU82		Mandarin PNS009	Navy MOG86	Wheat TPO02
Peacock CU97	INERTIA	Morel PNS001	Onyx MOG99	
Pear CU84	Amethyst NR61	Platinum PNS004	Verdant MOG44	TRISECT ^D
Poppy CU42	Calypso NR98	Turquoise PNS006	Waterfall MOG26	(100% Antimony free polyester)
Ruby CU67	Cherry NR66	BURST F		(Green Shield® stain-resistant finish)
CHATTERBOX ^D	Cobalt NR91	(100% Recycled Polyester)	NARRATIVE B, C, O, S, T	Brownstone TSC88
(38% Recycled Polyester)	Coffee NR49	(Greenshield Stain-Resistant)	(58% Recycled)	Cayenne TSC95
Caramel BOX14	Fog NR19	Auburn BST05	Buff NTV03	Marine TSC97
Glen BOX13	Fuchsia NR63	Cardinal BST07	Cerulean NTV09	Onyx TSC99
Midnight BOX15	Gecko NR76	Dove BST06	Conifer NTV10	Pebble TSC98
Mineral BOX11	Glow NR27	Indigo BST02	Cordovan NTV05	Sprout TSC94
Peat BOX12	Leaf NR75	Leek BST09	Falu Red NTV06	Surf TSC96
Pepper BOX16	Lime NR82	Poolside BST01	Mustard NTV07	Tangelo TSC92
Tomato BOX10	Loft NR22	Slate BST03	Pebble NTV02	
CONTOURETT	Mandarin NR47	Teak BST04	Prussian Blue NTV08	
Black UR10	Meteor NR30	Zinnia BST08	Umber NTV01	
Buff UR22	Mustard NR26		White Pepper NTV04	
Coffee Bean UR49	Nickel NR23	CLYDE NEW!		SEED
Flame UR62	Onyx NR10	(100% Recycled Polyester)		(100% Recycled Polyester)
Graphite UR19	Regatta NR90	(Greenshield Stain-Resistant)		(Greenshield Stain-Resistant)
Luggage UR26	Shadow NR12	Antique CLYD04		Apple SED11
Marine UR92	Surf NR96	Artifact CLYD01		Ash SED15
Ocean UR96	Tangelo NR46	Blacksmith CLYD10		Cardinal SED09
Pumpkin UR42	OPTIC	Claret CLYD13		Cinder SED17
Sage UR82	Aurora OP72	Craftsman CLYD08		Cream SED12
Steel UR21	Bark OP24	Crate CLYD12		Dahlia SED08
Taupe UR28	Canopy OP84	Fossil CLYD02		Driftwood SED13
	Char OP49	Heirloom CLYD05		Harbor SED10
	Dune OP16	Iron CLYD11		Lemon Balm SED07
	Forest OP82	Linens CLYD14		Onyx SED18
	Ruby OP42	Relic CLYD06		Silver Sage SED06
	Sand OP17	Seasoned CLYD03		Smoke SED16
	Sky OP83	Trestle CLYD07		Spring Beige SED04
	Slate OP19	Weathered CLYD09		Truffle SED14
	Sprout OP74	DOTTY		Twilight SED02
	Starry Night OP11	(45% Recycled Polyester)		Wenge SED03
	Storm OP56	Berry DOT62		
	Wildfire OP66	Black DOT10		SOCKHOP
		Crimini DOT28		(100% Recycled)
		Mosaic DOT26		Carbon HOP18
		Peat DOT24		Cobalt HOP12
		Pewter DOT19		Garnet HOP51
		Sepia DOT49		Graphite HOP11
		Tide DOT90		Lawn HOP61
		Toffee DOT76		Platinum HOP21
		Tomatillo DOT82		Pool HOP16
				Pumpkin HOP50
				Rattan HOP60
				Truffle HOP70
				Twilight HOP13

Multi-use Fabrics are seating fabrics that can be used on specific Allsteel systems, providing more color and pattern options. The applicable Allsteel Systems or products for Multi-use Fabrics are noted with the following designators:

B – Tackboards, **C** – Concensys®, **O** – Optimize™, **S** – Stride®, **T** – Terrace®, **F** – Further™

D Discontinued 12/15/2017

<p>GRADE 3</p> <p>IN SEASON</p> <p>Alabaster..... ISN040 Cactus..... ISN060 Ebony..... ISN021 Harbor..... ISN022 Lagoon..... ISN050 Limestone..... ISN041 Meadow..... ISN010 Sandstone..... ISN012 Shale..... ISN013 Smoke..... ISN020 Sunset..... ISN030 Tundra..... ISN011</p> <p>GRADE 4</p> <p>DOLCE</p> <p>Artesian..... DOL726 Black..... DOL728 Camel..... DOL709 Chocolate..... DOL713 Eceru..... DOL703 Fuchsia..... DOL720 Grass..... DOL722 Jet..... DOL724 Latte..... DOL706 Meteor..... DOL727 Mocha..... DOL712 Mushroom..... DOL708 Peacock..... DOL723 Poppy..... DOL719 Tangelo..... DOL718 White..... DOL701</p> <p>GRADE 5</p> <p>ROVE NEW!</p> <p>Drip..... SMHMROV14 Grackle..... SMHMROV12 Indigo..... SMHMROV13 Mum..... SMHMROV06 Nasturtium..... SMHMROV07 Pomelo..... SMHMROV16 Rind..... SMHMROV11 Soba..... SMHMROV02 Vixen..... SMHMROV08</p> <p>WOOLY F</p> <p>Bamboo..... WOL008 Black..... WOL005 Chaps..... WOL014 Charcoal Flannel..... WOL004 Framboise..... WOL012 Geranium..... WOL011 Grey Flannel..... WOL003 Lawn..... WOL009 Light Grey Mix..... WOL002 Marine..... WOL007 Natural Heather..... WOL001 Squash..... WOL010 Turquoise..... WOL006 Violet..... WOL013 Walnut..... WOL015</p>	<p>GRADE 6</p> <p>HEDGE NEW!</p> <p>Island..... SMHMHED04 Power..... SMHMHED06 Safari..... SMHMHED01 Succulent..... SMHMHED03 Vibrant..... SMHMHED08</p> <p>POCKET NEW!</p> <p>Bud..... SMHMPKT03 Dim..... SMHMPKT06 Fireside..... SMHMPKT07 Maritime..... SMHMPKT05 Pumice..... SMHMPKT01</p> <p>VERSE NEW!</p> <p>50..... SCARVRS50 51..... SCARVRS51 53..... SCARVRS53 54..... SCARVRS54</p> <p>GRADE 9</p> <p>ULTRALEATHER PRO NEW!</p> <p>Aubergine..... SUF554336 Blue Bird..... SUF554661 Blueberry..... SUF554711 Blush..... SUF554200 Butterfly..... SUF554216 Butternut..... SUF554241 Campfire..... SUF554229 Capri..... SUF554522 Char..... SUF554626 Chestnut..... SUF554214 Cloud..... SUF554648 Coastal..... SUF554530 Cork..... SUF554595 Cougar..... SUF554209 Cranberry..... SUF554357 Dark Chocolate..... SUF554376 Dark Knight..... SUF554618 Ember..... SUF554649 Laurel..... SUF554443 Mortar..... SUF554733 Parfait..... SUF554803 Persian Green..... SUF554453 Rhubarb..... SUF554329 Sailor..... SUF554547 Sea Mist..... SUF554478 Shore..... SUF554352 Sky..... SUF554530 Swan..... SUF554811 Toasted Bagel..... SUF554444 Tundra..... SUF554353 Violet..... SUF554395 White Wash..... SUF554008 Woodcres..... SUF554087</p>	<p>GRADE 11</p> <p>FUSHION NEW!</p> <p>10..... SCARFUS10 11..... SCARFUS11 12..... SCARFUS12 14..... SCARFUS14 15..... SCARFUS15</p> <p>GRADE 13</p> <p>MAZE NEW!</p> <p>31..... SCARMZE31 32..... SCARMZE32 33..... SCARMZE33 34..... SCARMZE34 36..... SCARMZE36 38..... SCARMZE38 39..... SCARMZE39 40..... SCARMZE40 41..... SCARMZE41 43..... SCARMZE43 44..... SCARMZE44 45..... SCARMZE45 46..... SCARMZE46 48..... SCARMZE48 49..... SCARMZE49</p> <p>GRADE 14</p> <p>CHROMA NEW!</p> <p>20..... SCARCHR20 22..... SCARCHR22 24..... SCARCHR24 25..... SCARCHR25</p>
---	---	---

Multi-use Fabrics are seating fabrics that can be used on specific Allsteel systems, providing more color and pattern options. The applicable Allsteel Systems or products for Multi-use Fabrics are noted with the following designators:
B – Tackboards, **C** – Concensys®, **O** – Optimize™, **S** – Stride®, **T** – Terrace®, **F** – Further™

ALLSTEEL PARTNERSHIP PROGRAM — REFERENCE COLORS AND CODES IN SEATING, COLLABORATION, AND TABLES PRICE LIST

Allsteel understands that customers may want to specify panel and seating textiles outside of Allsteel's standard offering. Allsteel's Partnership Program consists of on-trend and design-forward patterns that have been tested and approved by Allsteel for use on Allsteel products. A subset of these approved patterns is available on cards in the textile binder, while numerous others are available on our website, allsteeloffice.com.

For memo samples, please contact our partners:

- Edelman, edelmanleather.com 1.800.886.8339
- HBF Textiles, hbftextiles.com 1.877.494.5727
- Maharam, maharam.com 1.800.645.3943
- Momentum Textiles, memosamples.com 1.800.366.6839
- Ultrafabrics, ultrafabricsllc.com

The intent of the **Partnership Program** is to offer a wide variety of on-trend textiles to meet your varied needs, but since these textiles are not part of our standard offering they may be subject to extended lead times. Because new materials will be introduced regularly, Allsteel reserves the right to change the offering at any time.

Upholstery Selections for Involve by Model/Series

Upholstery colors and codes for standard fabrics are listed on pages 192 and 193. Partnership (⊕) upholstery colors and codes are listed in the Seating, Collaboration and Tables Price List.

GRADE	UPHOLSTERY	CODE	Banquette/Seat Cushions	Ped/Credenza Cushions
1	Attire	AI	◆	◆
1	Centurion	CU	◆	◆
1	Chatterbox	BOX	◆	◆
1	Contourett	UR	•	•
1	Dapper	DAPR	◆	◆
1	Inertia	NR	◆	◆
1	Optic	OP	•	•
1	Perennial	PNL	◆	◆
2	Appoint Seating	PNS	◆	◆
2	Burst	BST	◆	◆
2	Clyde NEW!	CLYD	•	•
2	Dotty	DOT	◆	◆
2	Hotspot	HTS	◆	◆
2	Moguls	MOG	◆	◆
2	Narrative	NTV	◆	◆
2	Seed	SED	◆	◆
2	Sockhop	HOP	◆	◆
2	Spin Seating	SPNN	◆	◆
2	Tempo	TPO	◆	◆
2	Trisect	TSC	◆	◆
3	In Season	ISN	◆	◆
4	Blip ⊕	SCFSBLP		•
4	Decode ⊕	SMOMDEC	•	•
4	Dolce	DOL	◆	
4	Habit ⊕	SMOMHAB	•	•
4	Hi-Fi ⊕	SCFSHIF	•	•
4	Hive ⊕	SCFSHVE		•
4	Manner ⊕	MAN	◆	◆
4	Medium ⊕	MDM	◆	◆
4	Messenger ⊕	GRM	•	•
4	Metric ⊕	MET	◆	◆
4	Retrograde ⊕	SCFSRET		•
4	Scrabble ⊕	SMOMSCR	•	•
4	Skip ⊕	SMOMSKP	•	•
5	Against The Grain ⊕	AGG	•	•
5	Boom II ⊕	SMOMBOO	•	•
5	Cover Cloth ⊕	SMOMCOV	◆	◆
5	Ledge ⊕	SMOMLDG	•	•
5	Mode ⊕	SMHMMOD	•	•
5	Rib Stitch ⊕	RIB	•	•
5	Riddle ⊕	SCFSRID	•	•
5	Rivet ⊕	SMOMRVT	•	•
5	Rove ⊕ NEW!	SMHMROV	•	•
5	Sequence ⊕	SCFSSEQ		•
5	Strut ⊕	SMOMSUT	•	•
5	Wooly	WOL	◆	◆

GRADE	UPHOLSTERY	CODE	Banquette/Seat Cushions	Ped/Credenza Cushions
6	Abacus Standard ⊕	ABC		
6	Hedge ⊕ NEW!	SMHMHED	•	•
6	Pocket ⊕ NEW!	SMHM PKT	•	•
6	Runner Standard ⊕	RNR		
6	Verse ⊕ NEW!	SCARVRS	•	•
7	Bevel ⊕	BVL		
7	Bumpy ⊕	BPY	◆	◆
7	Exchange ⊕	MEX	•	•
7	Plait ⊕	PLT		
7	Shuttle Standard ⊕	STL		
7	Waxen ⊕	WXN		
8	Brisa ⊕	RS	◆	
8	Crossing The Line ⊕	CRL	•	•
8	Promessa ⊕	PRO	•	•
9	Chatterbox-GI ⊕	CAT	•	•
9	Equation ⊕	EQU	◆	◆
9	I-Beam ⊕	IBE	◆	◆
9	Silica ⊕	XX	◆	◆
9	Silica Etch ⊕	XX	•	•
9	Silica Leather ⊕	XX	•	•
9	Silica Tech ⊕	XX	◆	◆
9	Ultraleather Pro ⊕ NEW!	SUF554		•
10	Andante Encore ⊕	XX	•	•
11	Abito ⊕	XX		
11	Four of a Kind ⊕	XX	•	•
11	Fusion ⊕ NEW!	SCARFUS	•	•
12	Silica Deflect ⊕	XX	•	•
12	Silica Reach ⊕	XX	•	•
12	Silica Stride ⊕	XX	•	•
13	Maze ⊕ NEW!	SCARMZE	•	•
14	Chrome ⊕ NEW!	SCARCHR	•	•
14	Hipster ⊕	XX	◆	◆

- Available upholstery option
- ◆ Available upholstery option with CTB133 approval — requires FC suffix added to model (FC extra, \$ varies by series)
- ⊕ Partnership Program — See page 193 for details.

GRADE A

APPOINT PANEL

100% Polyester

Artichoke.....	APN911
Blackberry.....	APN932
Bronze.....	APN922
Carbon.....	APN928
Chai.....	APN912
Cherry.....	APN930
Copper.....	APN918
Dark Pewter.....	APN917
Dune.....	APN915
Espresso.....	APN923
Framboise.....	APN931
Frost.....	APN934
Hummus.....	APN914
Jet.....	APN927
Lawn.....	APN925
Mandarin.....	APN929
Morel.....	APN909
Nimbus.....	APN916
Platinum.....	APN924
Turmeric.....	APN910
Turquoise.....	APN926
Walnut.....	APN913

ELEMENT

100% Polyester

Flint.....	GN965
Indigo.....	GN967
Latte.....	GN973
Millet.....	GN972
Parchment.....	GN953
Sea.....	GN974
Veil.....	GN913
Warm Beige.....	GN955
Wisp.....	GN975

ETCH

100% Polyester

Aquatint.....	ECH901
Crosshatch.....	ECH904
Engrave.....	ECH902
Intaglio.....	ECH906
Lithograph.....	ECH903
Mezzotint.....	ECH907
Woodcut.....	ECH905

EXCHANGE

100% Polyester

Florin.....	EXG908
Franc.....	EXG902
Krona.....	EXG907
Lira.....	EXG906
Riyal.....	EXG901
Rupee.....	EXG903
Tolar.....	EXG904

LANDSCAPE

100% Polyester

Corn silk.....	LN15
Drift.....	LN05
Khaki.....	LN20
Sheen.....	LN10
Slate.....	LN35
Umber.....	LN25
Urban.....	LN30

D Discontinued 12/15/2017

GRADE A – continued

LUCY

100% Recycled Polyester

Aspen.....	LC932
Corn silk.....	LC930
Dusk.....	LC922
Fawn.....	LC933
Graphite.....	LC934
Mist.....	LC920
Neutra.....	LC924
Pewter.....	LC935
Snowdrop.....	LC928

REFLECTIONS

100% Recycled Polyester

Bamboo.....	REF926
Galvanized.....	REF929
Ice.....	REF920
Loggia.....	REF921
Mistral.....	REF928
Moonstone.....	REF923
Pewter.....	REF922
Stainless.....	REF924
Vanilla.....	REF925
Winter.....	REF927

REFUGE

*64% Recycled Polyester
36% Polyester*

Artesian.....	RFG996
Dune.....	RFG992
Eclipse NEW!	RFG990
Frost †.....	RFG993
Glacier † NEW!	RFG991
Hemp.....	RFG997
Mineral.....	RFG998
Sandbar.....	RFG995
Tidal.....	RFG994

SARTO

100% Polyester (45% Recycled)

Ash.....	SRT988
Desert.....	SRT933
Earth.....	SRT937
Fog.....	SRT914
Lemongrass.....	SRT949
Meadow.....	SRT925
Mist.....	SRT945
Mushroom.....	SRT976
Oyster.....	SRT918
Reef.....	SRT964
Sesame.....	SRT993
Shale.....	SRT952
Sisal.....	SRT929
Wheat.....	SRT913

TANGO

100% Polyester

Aficionado.....	TG994
Azul.....	TG993
Bongo.....	TG980
Dip.....	TG982
Palma.....	TG991
Pecan.....	TG985
Pistachio.....	TG986
Playa.....	TG933
Salsa.....	TG987
Sol.....	TG992
Tequila.....	TG990

TEMPEST

100% Recycled Polyester

Dragonfly.....	TP930
Frost.....	TP915
Full Stream.....	TP980
Ginger.....	TP925
Gold Rush.....	TP910
Sandstorm.....	TP950
Slate.....	TP945
Tumbleweed.....	TP970
Wind Chill.....	TP940
Zebra.....	TP935

GRADE B

COAST †

100% Antimony-Free Polyester

Channel.....	COA914
Dune.....	COA903
Fjord.....	COA905
Headlands.....	COA910
Humus.....	COA907
Marsh.....	COA902
Pebble.....	COA912
Pier.....	COA913
Shoal.....	COA901
Silt.....	COA906
Tide.....	COA908
Tombolo.....	COA909

LUSTER †

100% Polyester (79% Recycled)

Citron.....	LUS907
Crimson.....	LUS908
Darkness.....	LUS906
Earth.....	LUS903
May Sky.....	LUS904
Night Shadow.....	LUS905
Rockies.....	LUS901
Sandstorm.....	LUS902

MICA

100% Recycled Polyester

Anthracite.....	MCA911
Breeze.....	MCA918
Bronze.....	MCA913
Buff.....	MCA914
Cremini.....	MCA917
Crystal †.....	MCAW1T
Dew.....	MCA920
Dove.....	MCA912
Fresh.....	MCA916
Mineral.....	MCA915
Nectar.....	MCA919
Shale.....	MCA910

SPIN PANEL

*46% Recycled Polyester,
56% Polyester*

Alabaster.....	SPIN02
Cavern.....	SPIN03
Cobblestone.....	SPIN04
Ember.....	SPIN06
Flame.....	SPIN07
Heron.....	SPIN13
Oat.....	SPIN01
Ocean.....	SPIN12
Plum.....	SPIN15
Pool.....	SPIN11
Raven.....	SPIN10
Rhubarb.....	SPIN14
Tropic.....	SPIN08
Willow.....	SPIN05

TASANEE ♦ **D**

100% Polyester

Birch.....	TSN936
Cinder.....	TSN959
Citrus.....	TSN987
Cumin.....	TSN998
Feather.....	TSN924
Frost.....	TSN951
Pebble.....	TSN948
Silk.....	TSN912
Water.....	TSN963
Willow.....	TSN975

TERRAIN

*52% Recycled Polyester,
48% Polyester*

Bay.....	TRRN05
Bayou.....	TRRN35
Canyon.....	TRRN30
Cliff.....	TRRN45
Crest.....	TRRN25
Delta.....	TRRN10
Plateau.....	TRRN15
Ridge.....	TRRN20
Valley.....	TRRN40

ALLSTEEL

PARTNERSHIP PROGRAM

See page 193 for detailed explanation of Partnership Program.

GRADE C

PACT † ♦

Aloe**.....	PAC900
Azure.....	PAC911
Calla**.....	PAC922
Coastal.....	PAC933
Delft.....	PAC944
Dove**.....	PAC955
Dragon.....	PAC966
Eureka.....	PAC977
Fern.....	PAC988
Harbour.....	PAC999
Lily.....	PAC910
Lime.....	PAC921
Midnight.....	PAC932
Nectar.....	PAC943
Patina.....	PAC954
Putty**.....	PAC965
Roast.....	PAC976
Roma.....	PAC987
Rubine.....	PAC998
Sketch.....	PAC909
Tanzanite.....	PAC920
Taupe**.....	PAC931
Toasty**.....	PAC942

** Colors not available on tackboards

SCRIPT

Almond.....	PMOMSCP01
Charcoal.....	PMOMSCP12
Feldspar.....	PMOMSCP23
Flint.....	PMOMSCP34
Nectar.....	PMOMSCP45
Patina.....	PMOMSCP56
Pebble.....	PMOMSCP67
Sand.....	PMOMSCP78
Shadow.....	PMOMSCP89
Slate.....	PMOMSCP00
Sterling.....	PMOMSCP11
Taupe.....	PMOMSCP22
Zinc.....	PMOMSCP33

† Panel fabric is not available on Optimize® or Concensys®.

♦ Panel fabric is not available on Involve.

SPECIFICATION AND PRICE LIST 2017

prices effective January 29

SHOWROOMS

Atlanta

Boston

Chicago

Dallas

Los Angeles

New York

San Francisco

Washington, DC

Allsteel®

Allsteel Inc.
Muscatine, Iowa 52761-5257

allsteeloffice.com

©2017 Allsteel Inc.
All registered trademarks and trademarks are the property of Allsteel Inc.
PANTONE is property of Pantone, Inc.